

CATALOGUE OF DRAWINGS FOR WROUGHT IRONWORK

1	Door Furniture
13	Fireside Furniture
27	Lighting
65	Grilles
79	Plant Stands and Brackets
87	Sign Stands and Brackets
99	Lecterns
103	Weather Vanes
129	Furniture
135	Sundials
141	Balustrades and Railings
153	Miscellaneous
167	Gates
213	Tools
219	Leaf development

Designed by the
Rural Development Commission
141 Castle Street
Salisbury, Wiltshire SP1 3TP

ISBN 0 854070 28 1

December 1973
Revised and reprinted August 1976
Revised and reprinted July 1979
Reprinted March 1983
Reprinted December 1985
Reprinted March 1989
Reprinted March 1995
Reprinted April 1996

Printed and bound in Great Britain by
BAS Printers Ltd, Over Wallop, Stockbridge, Hants

INTRODUCTION

This "Catalogue of Drawings for Wrought Ironwork" is an enlarged and revised edition. It has been divided into 15 sections, for easy reference, each with a title page listing the dimensions of the drawings in the section. It is nearly always possible to modify these sizes if they do not suit a particular requirement, in which case an extra drawing fee will be involved.

To order a drawing, simply state the number in the catalogue and enclose the remittance. A full-size drawing will be sent (together with a scale print in the case of large pieces, such as double gates, etc.).

The catalogue illustrates a large variety of ironwork, developed over many years. It is appreciated, however, that it will not fulfil every requirement, and the Commission will gladly estimate for, and undertake, special drawings on receipt of a rough sketch or description. It is important to give accurate dimensions, particularly when the piece has to fit a permanent fixture, such as gates to be hung between existing piers, etc.

The drawings and catalogue illustrations are the copyright of the Commission, and only in exceptional circumstances will permission be given to reproduce them. Permission must be obtained in writing.

A current price list is enclosed. It will be revised from time to time.



Door Furniture

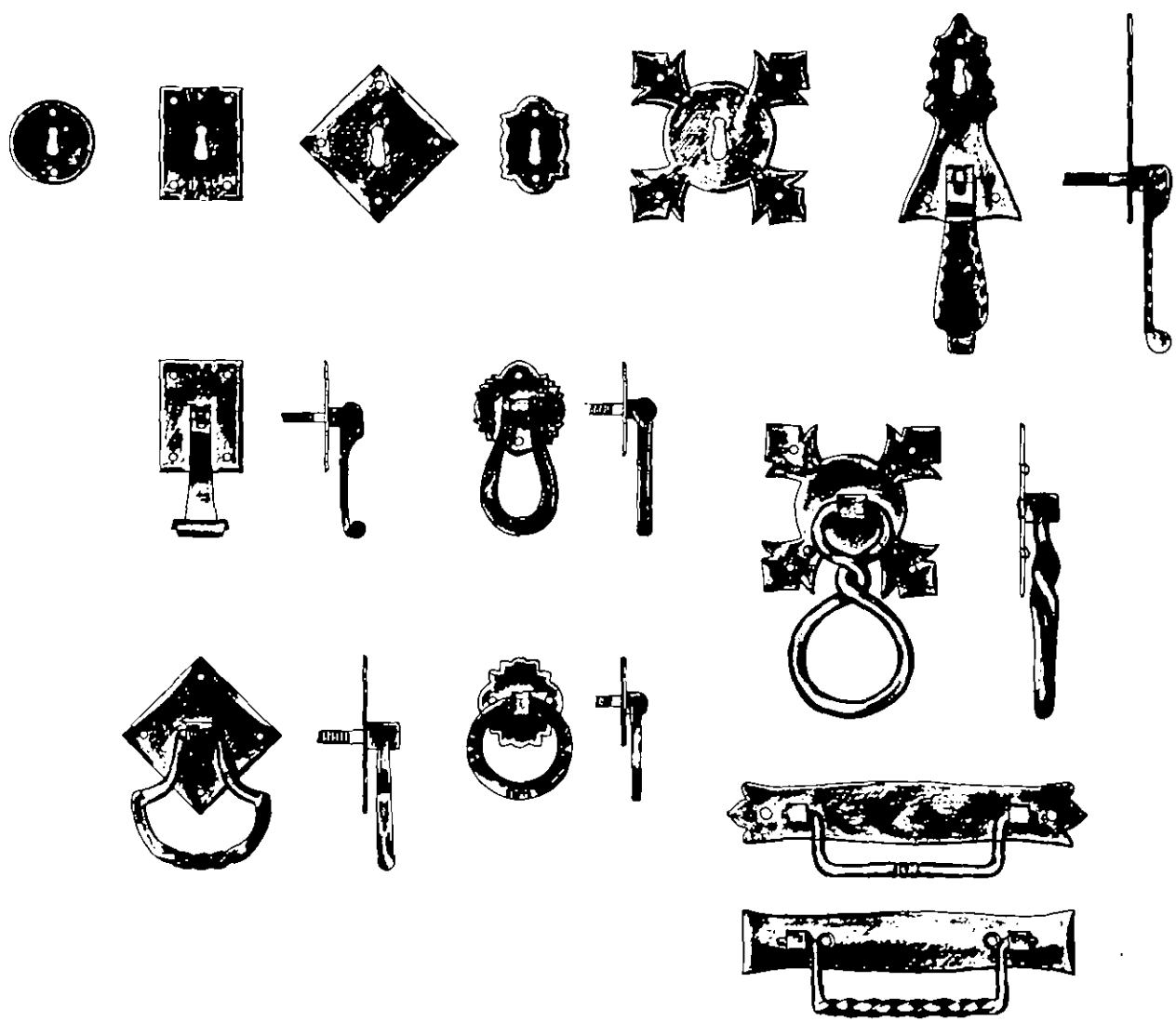

1

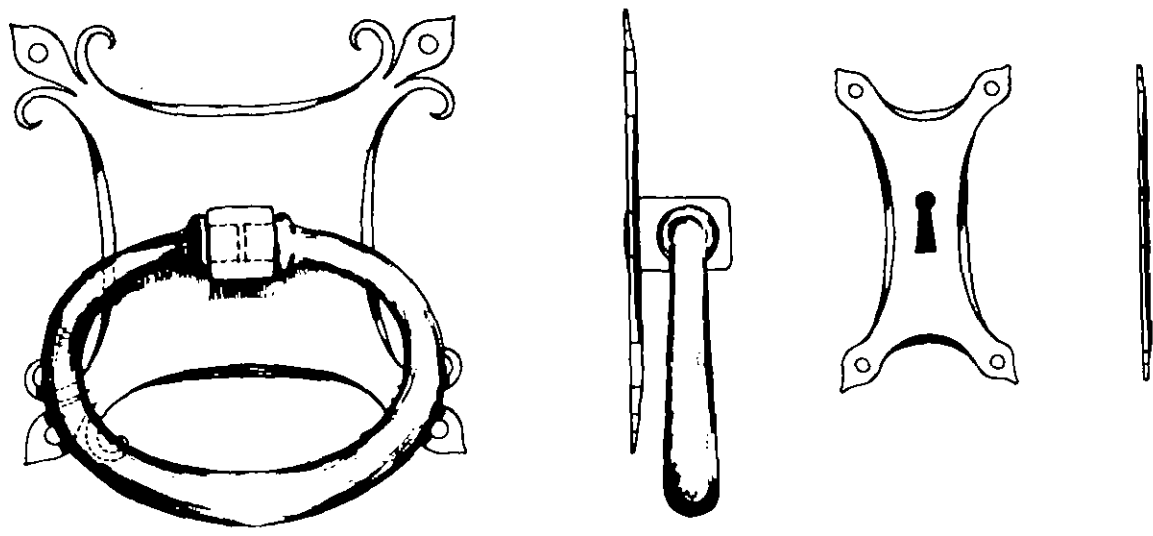

2

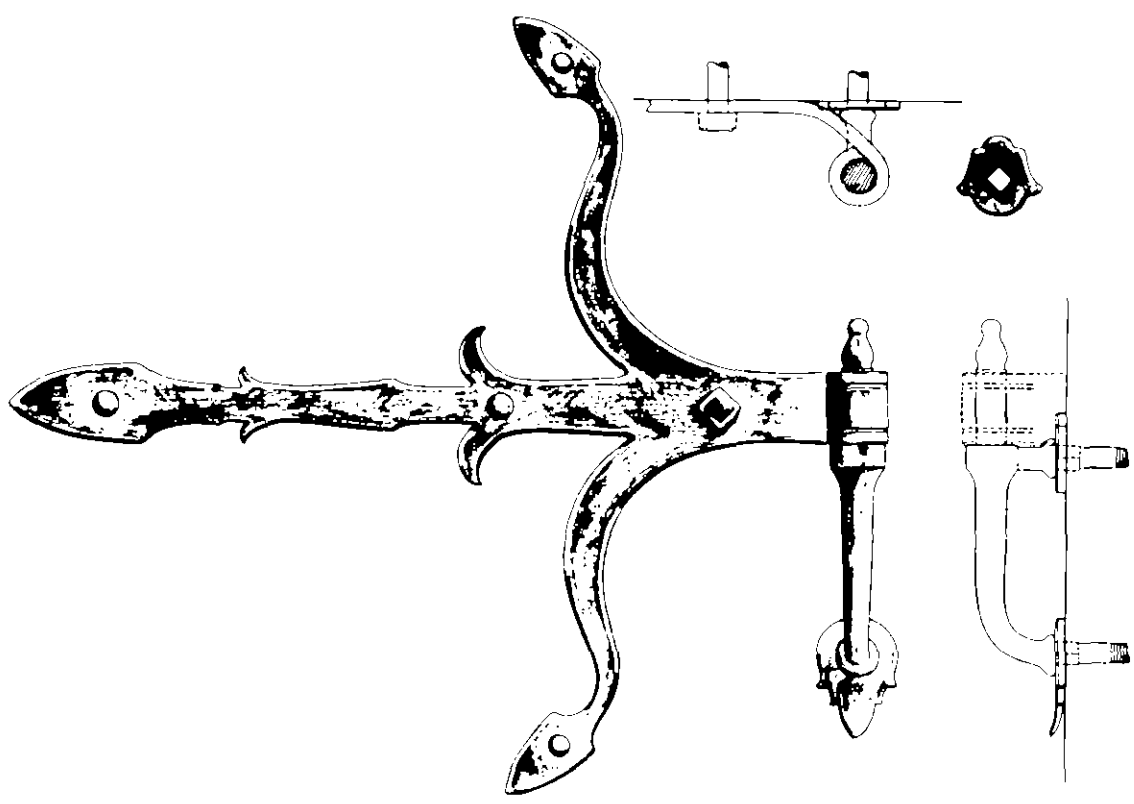

3

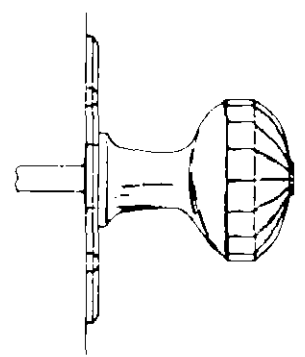
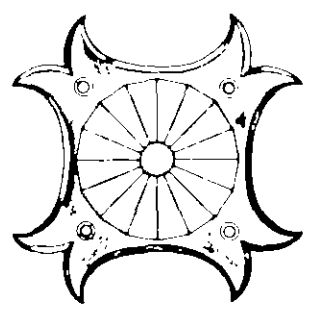
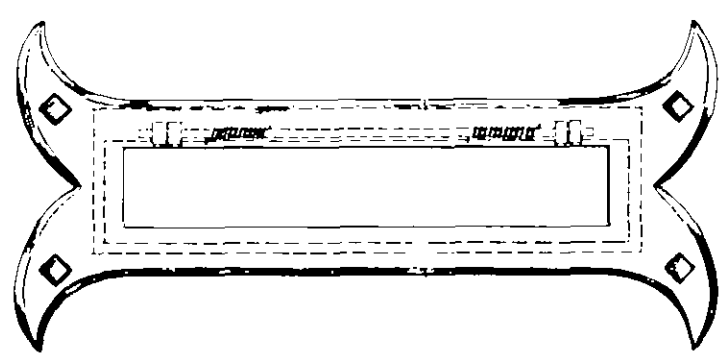
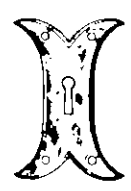

4

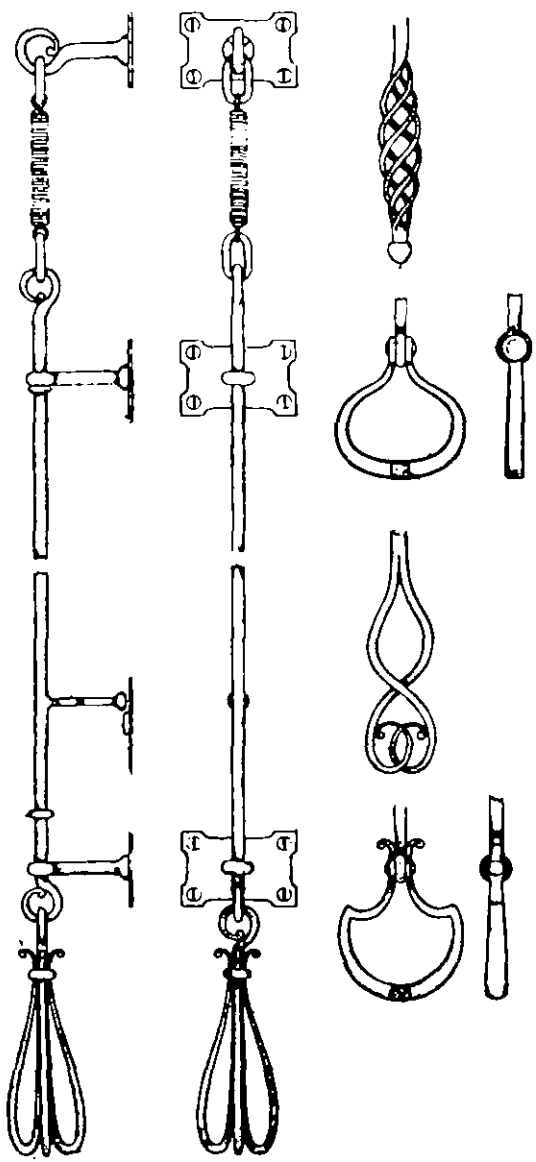

5

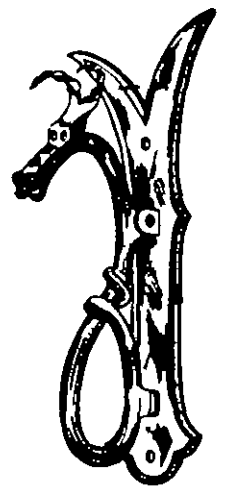

6

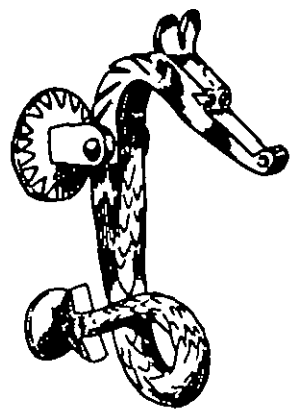

7

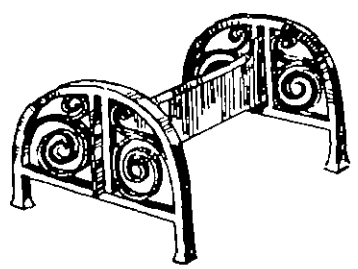

8



9

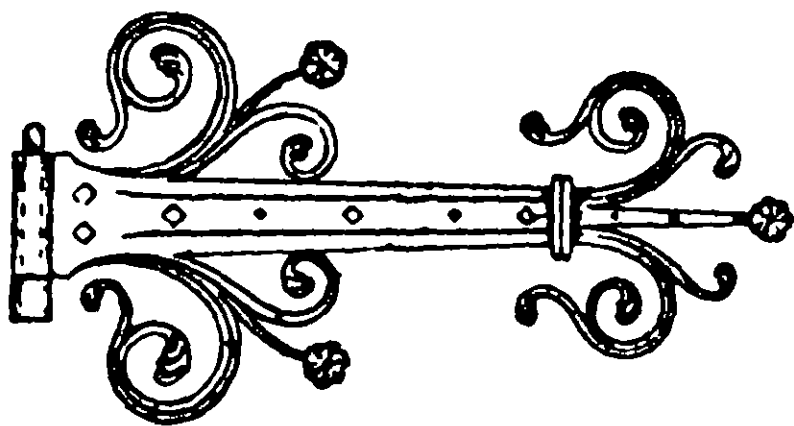

10

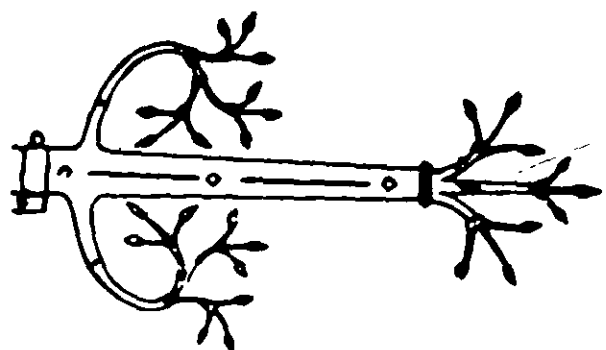

11

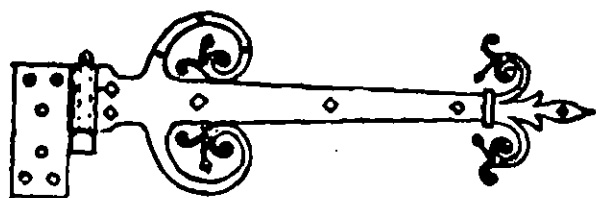

12

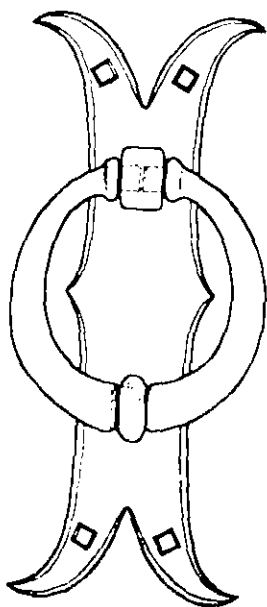

13



14

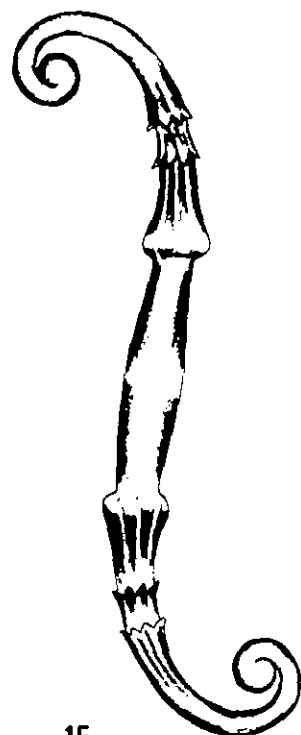

15

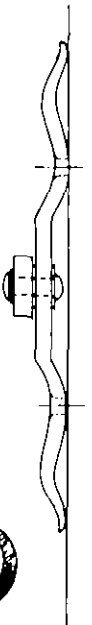
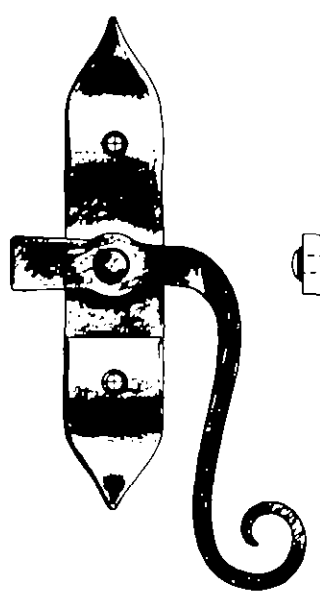
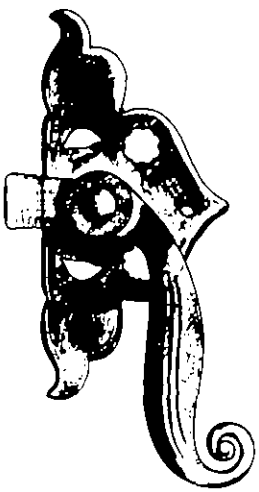
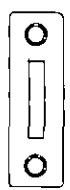
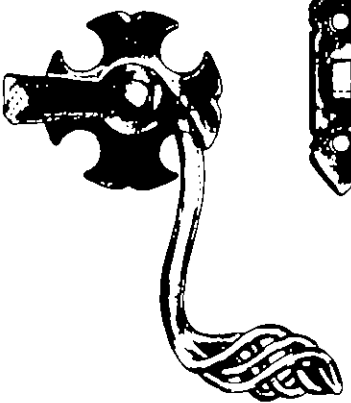
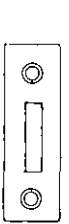

16

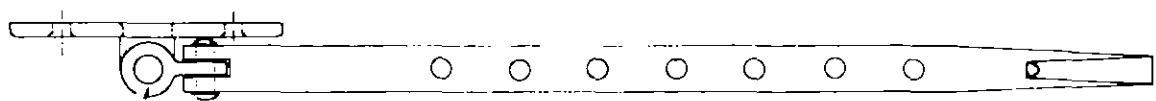

PLAN

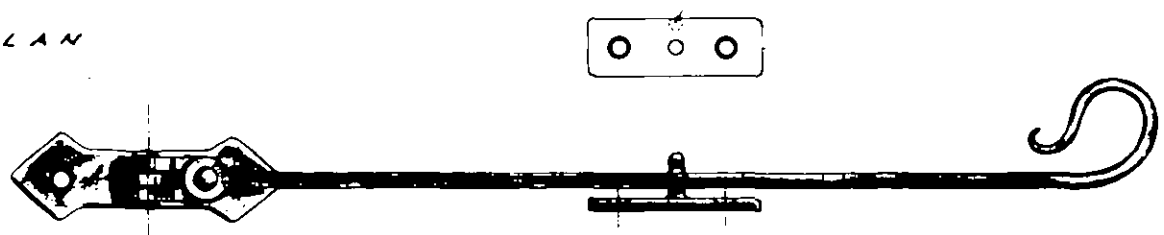

SIDE VIEW

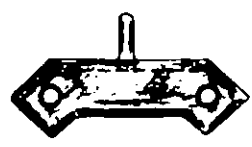
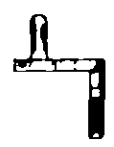

ALTERNATIVE END FOR STAY

ALTERNATIVE PLATE WITH PIN

DESIGN FOR CASEMENT STAY

17

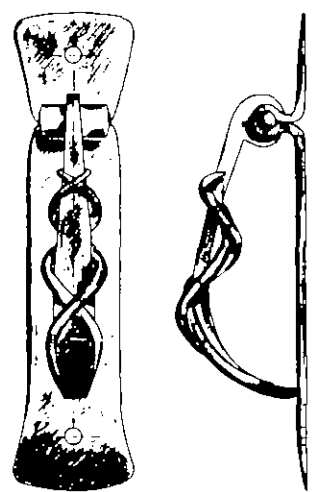

18

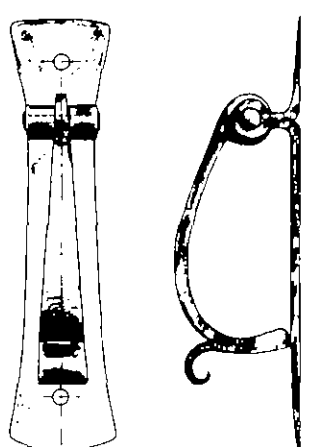

19

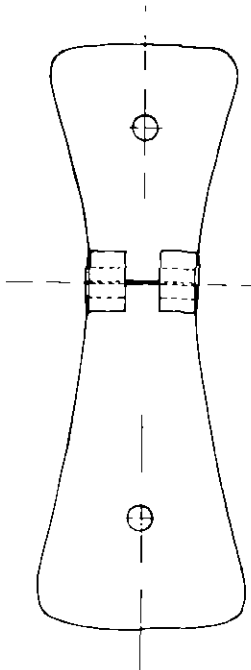

20

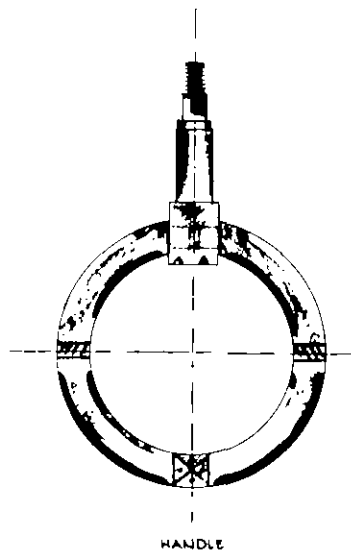

HANDLE

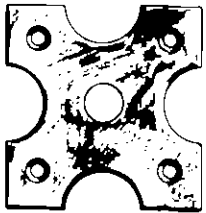

FRONT PLATE

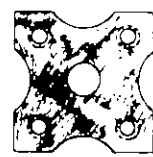

BACK PLATE

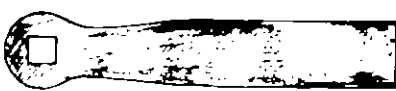

5 - LATCH

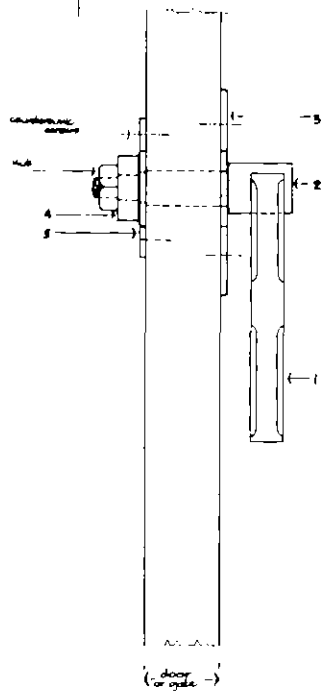

21

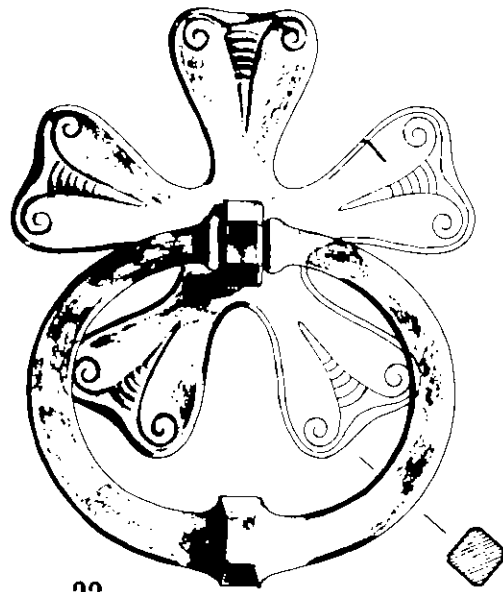

22

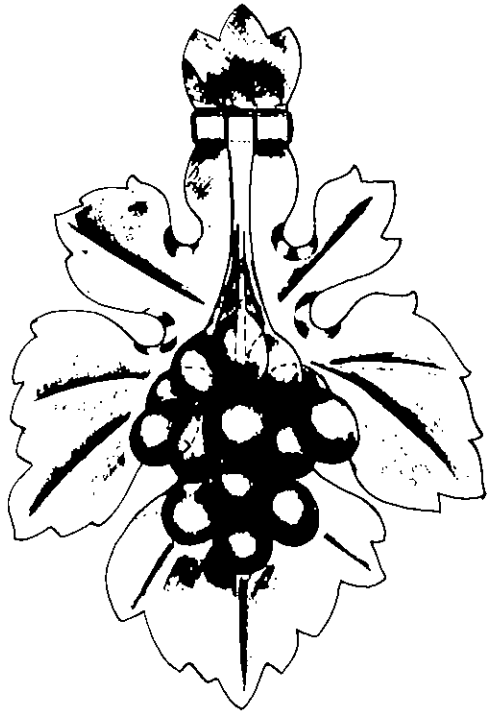

23

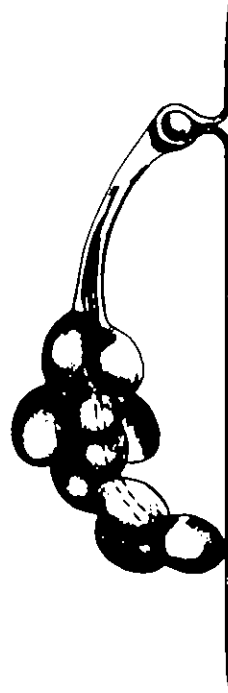

24

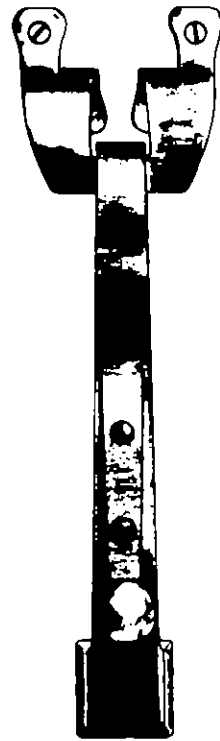

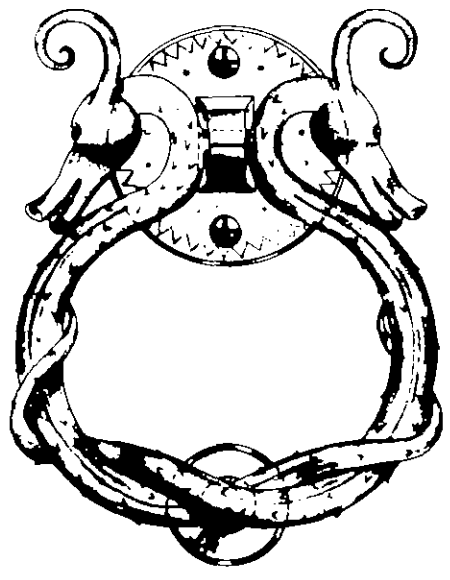

25

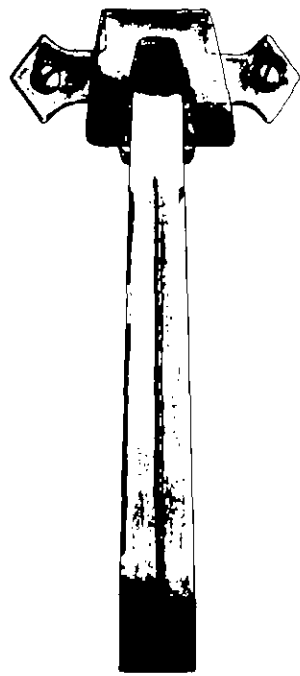
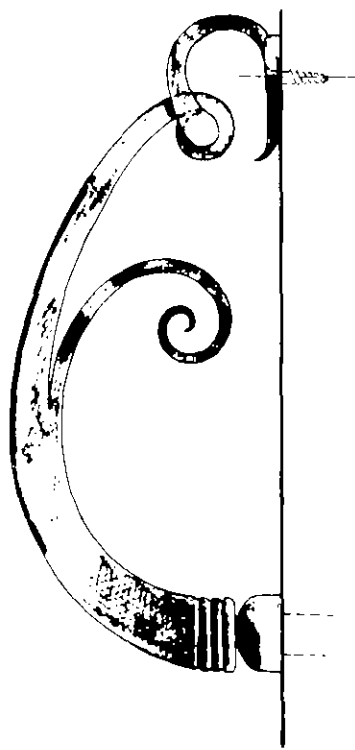
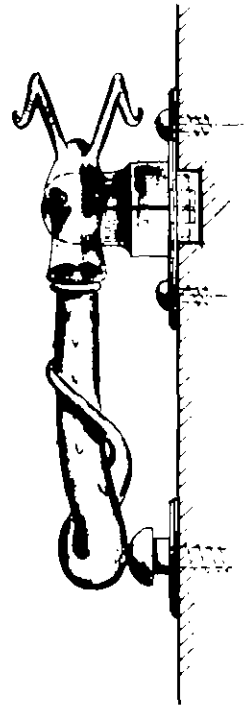

26

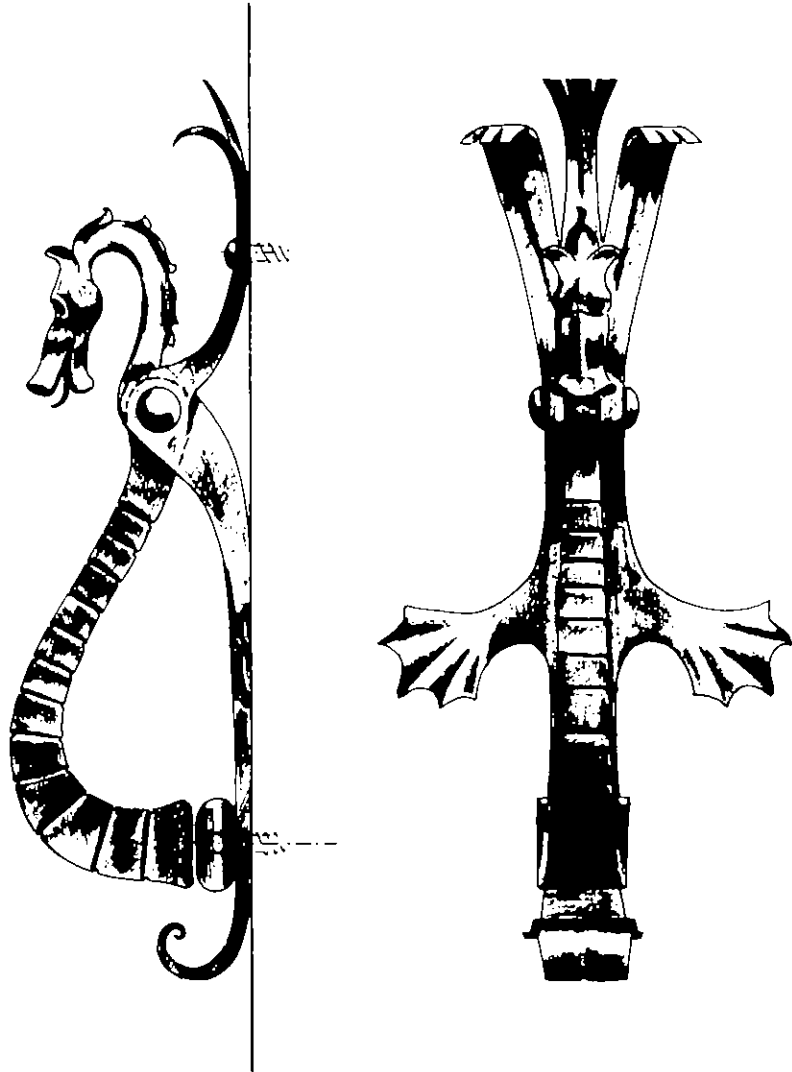

Fireside Furniture

165	2'2"
166	1'10" x 6" x 1'1"
167	1'4" x 10" x 8"
168	3'3" x 2'0"
169	1'0 $\frac{3}{4}$ " x 1'0 $\frac{1}{2}$ " x 1'0 $\frac{1}{2}$ "
170	1'11" x 1'2 $\frac{1}{2}$ "
171	2'0" x 10"
172	1'5" x 10 $\frac{1}{2}$ "
173	1'7" x 10 $\frac{1}{2}$ "
174	1'5" x 6" x 9"
175	{ 1'5 $\frac{1}{2}$ " x 9 $\frac{1}{2}$ " x 11" 2'2 $\frac{1}{2}$ " x 1'1" x 1'1"
176	{ 2'0" x 1'4" x 10" 1'4 $\frac{1}{2}$ " x 1'1 $\frac{1}{2}$ " x 1'0"
177	3'9" x 2'0"
178	1'6"
179	2'0"
180	10"
181	1'6"
182	1'6"
183	6 $\frac{3}{4}$ "
184	6 $\frac{1}{4}$ "
185	1'6"
186	1'3 $\frac{3}{4}$ "
187	1'6 $\frac{3}{4}$ "
188	1'6"
189	1'6"
190	2'6 $\frac{1}{2}$ "
191	1'8 $\frac{3}{8}$ "
192	1'3" & 1'8"
193	1'4"
194	1'6 $\frac{1}{2}$ "
195	1'2 $\frac{1}{2}$ "
196	1'8"
197	2'0"
198	2'10" x 2'1 $\frac{3}{8}$ "
199	1'11 $\frac{1}{2}$ " x 1'9"
200	1'9" x 2'6"
201	1'10 $\frac{1}{2}$ " x 2'0 $\frac{3}{8}$ "
202	2'3" x 2'1"
203	2'6" x 2'1" sheet
204	7' or as required
205	7' or as required

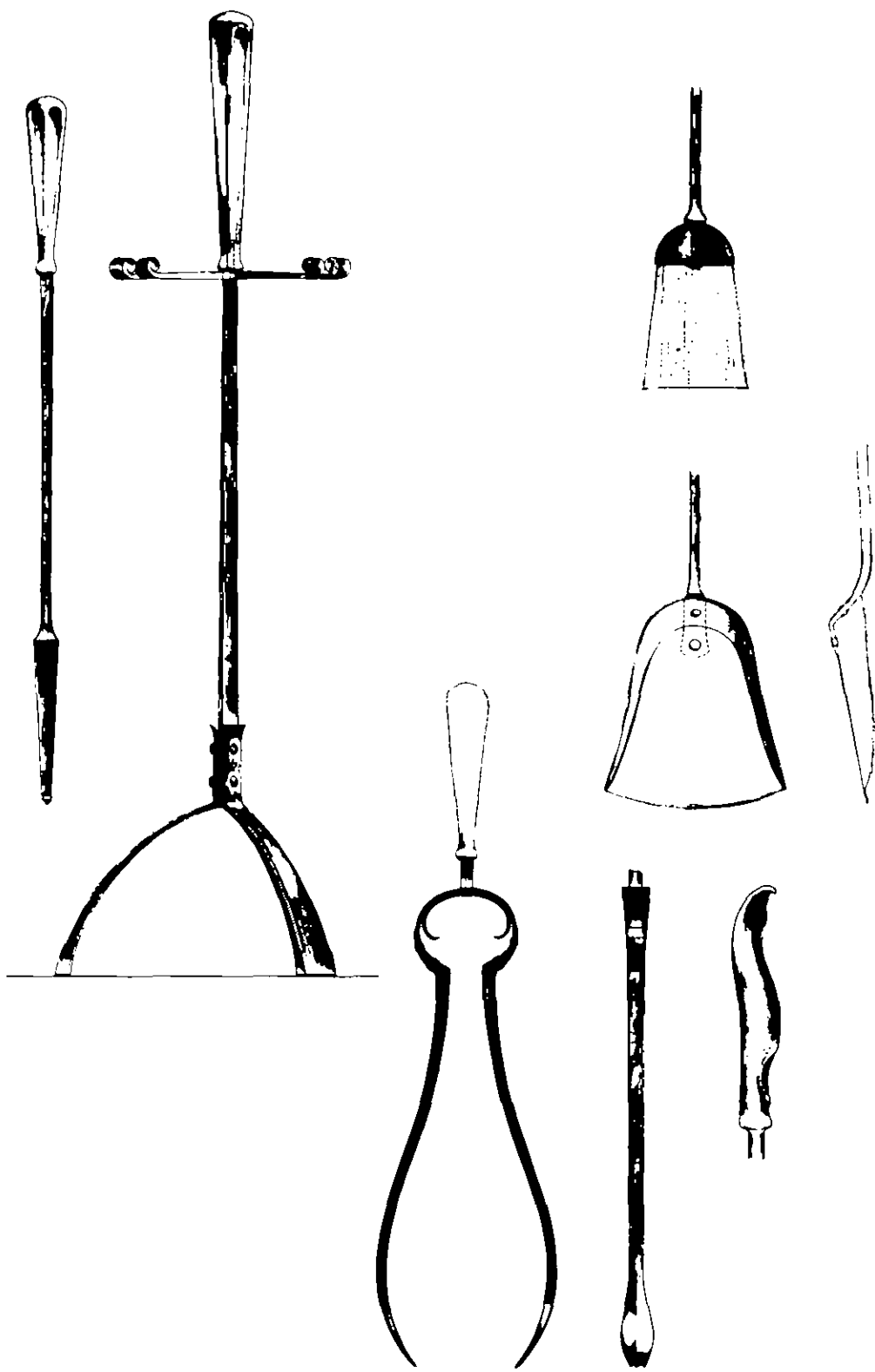

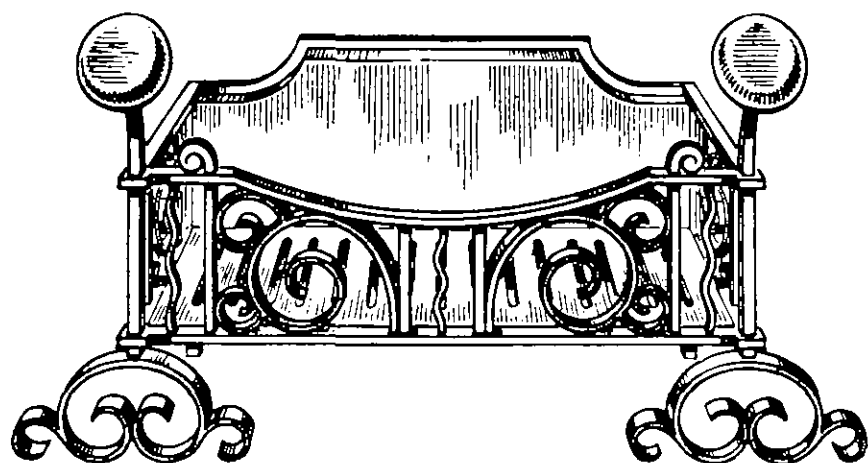

166

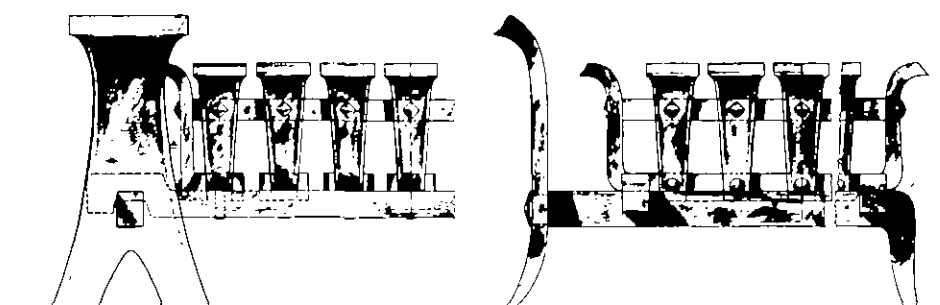

167

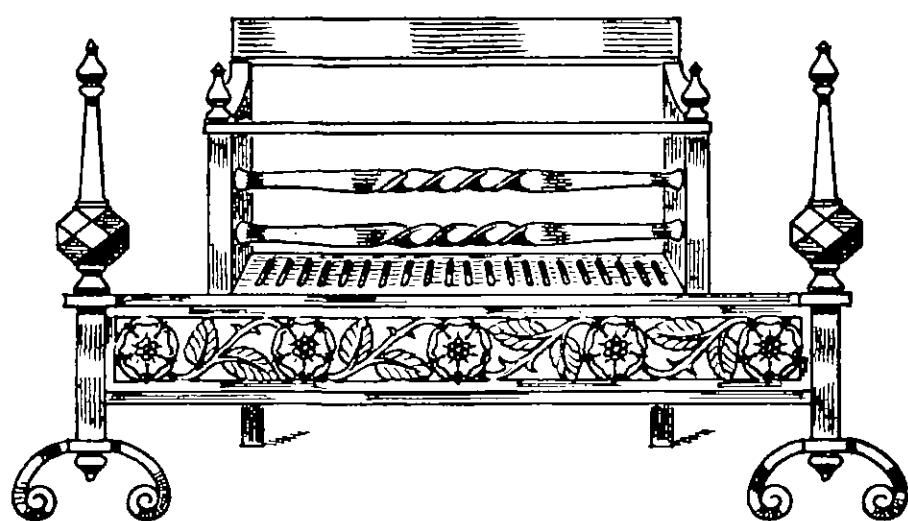

168

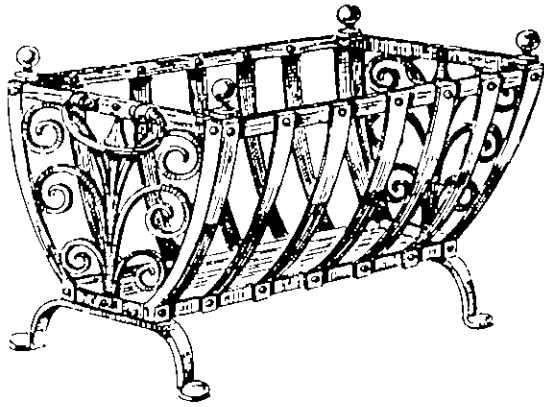

169



170

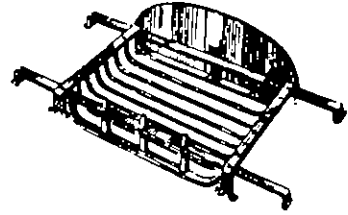

171

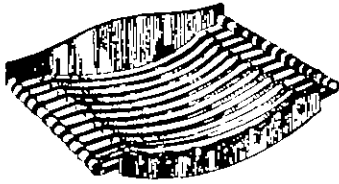

172

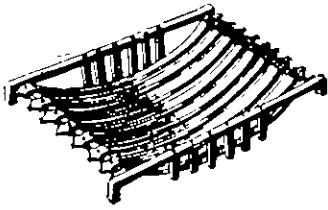

173

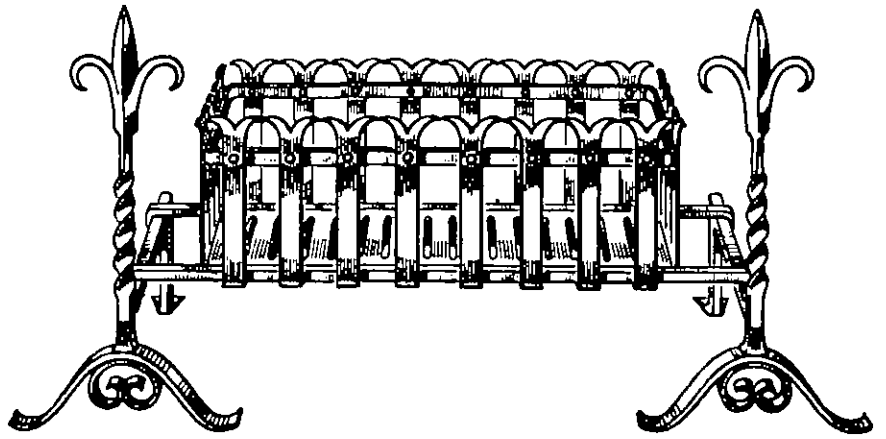

174

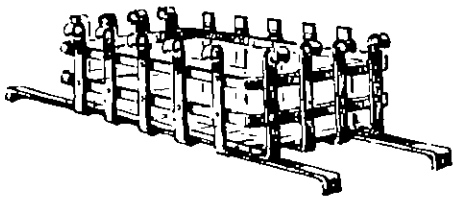

175

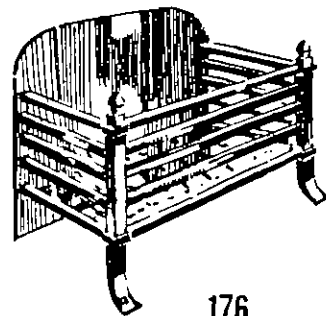

176

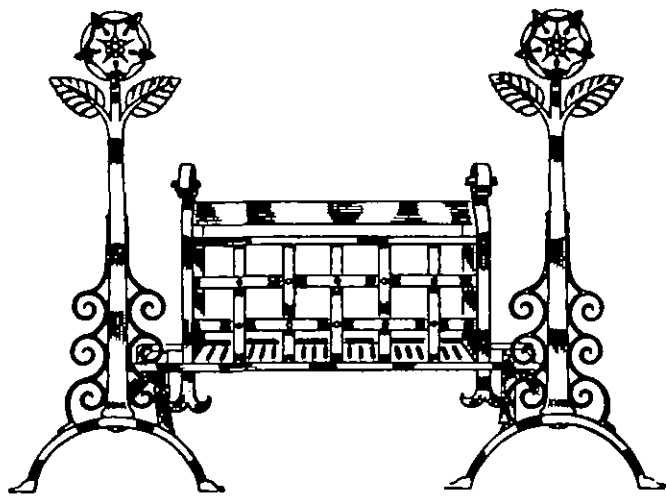

177

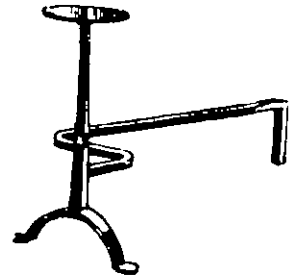

178

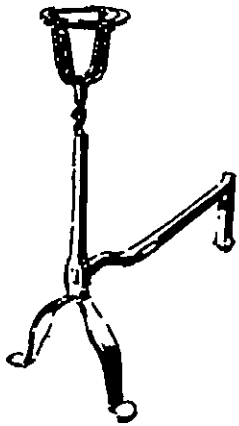

179

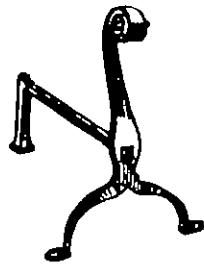

180

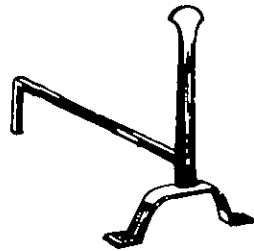

181

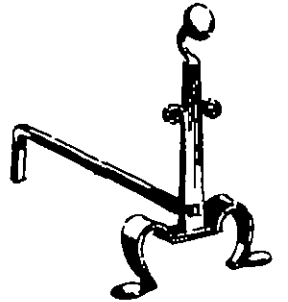

182

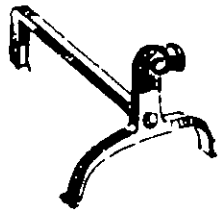

183

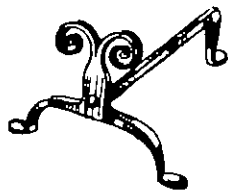

184

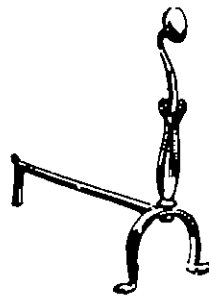

185

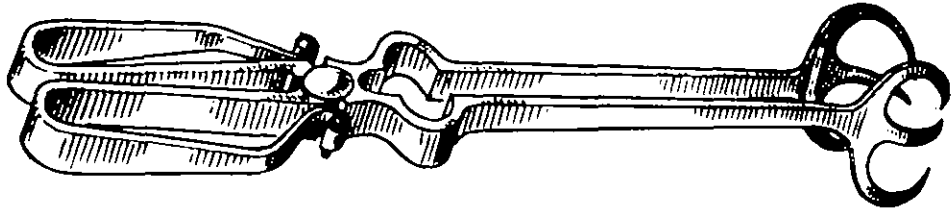

186

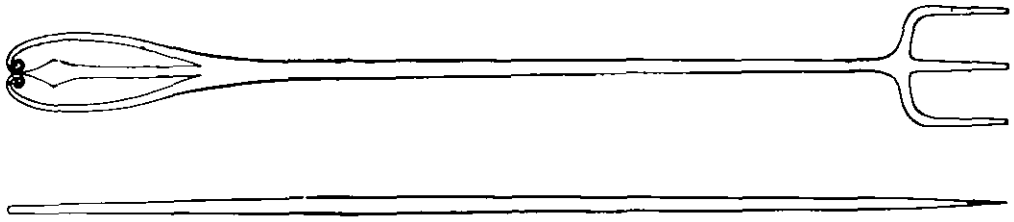

187

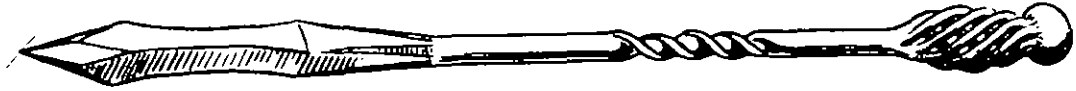

188



189

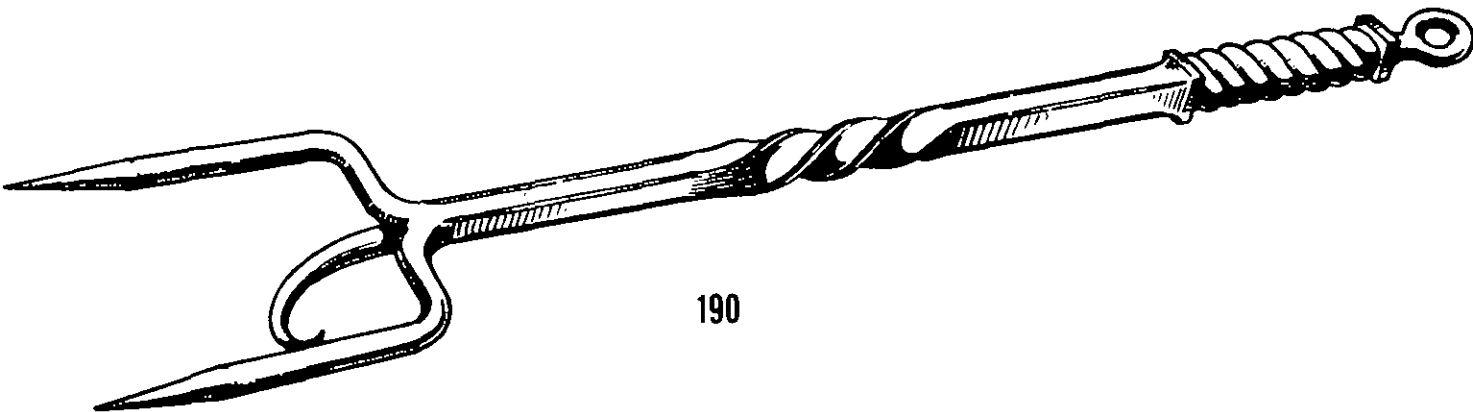

190

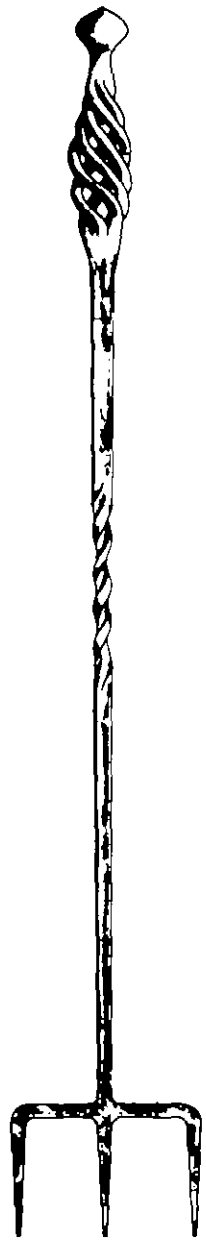

191

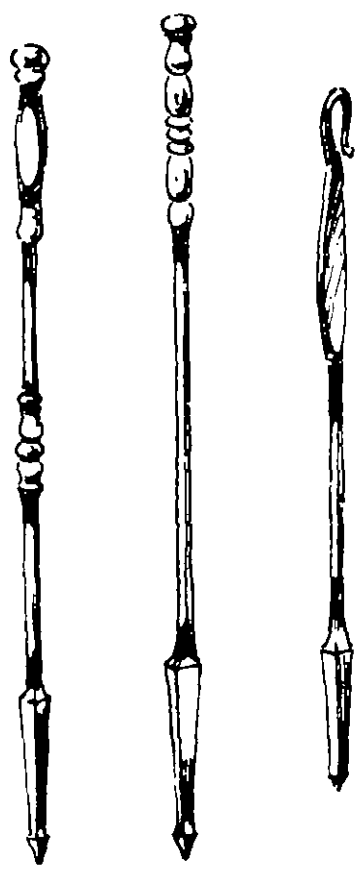

192

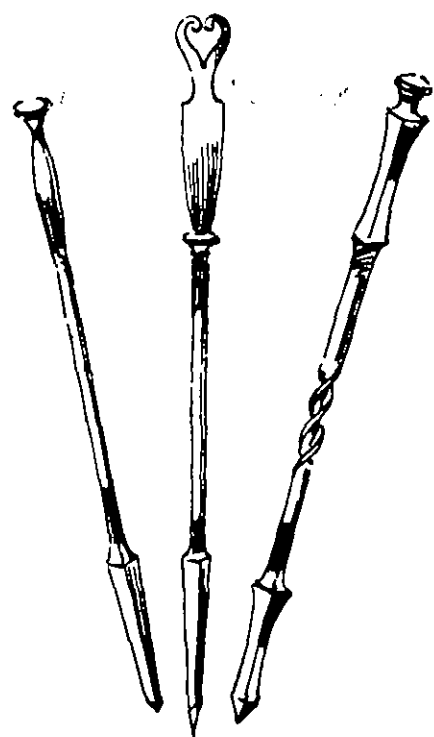

193



194

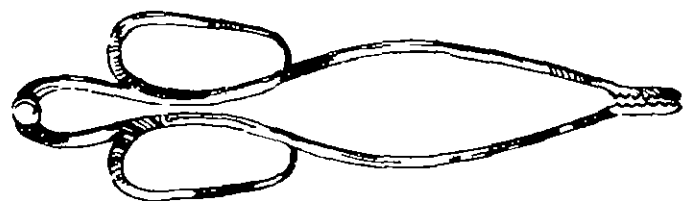

195

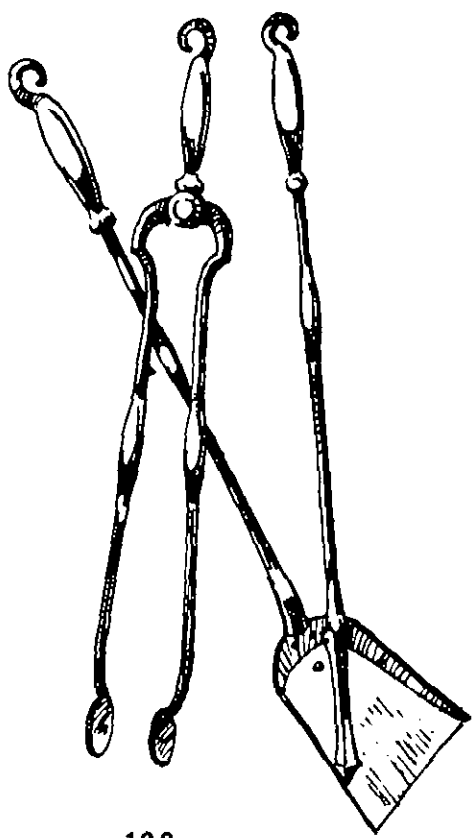

196

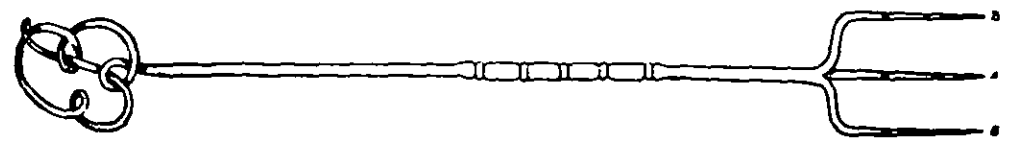
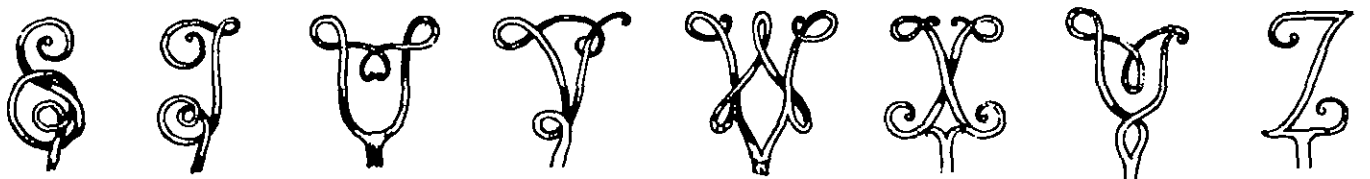
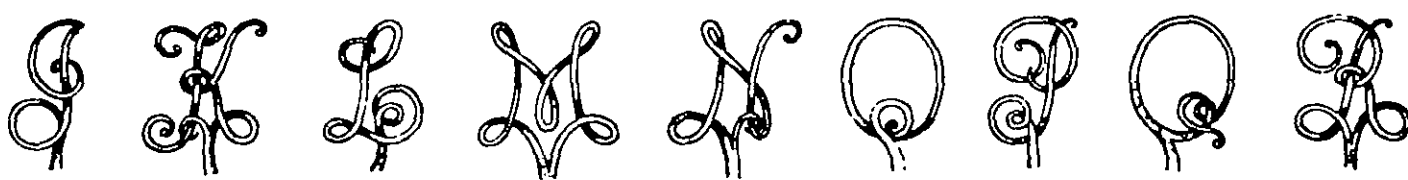
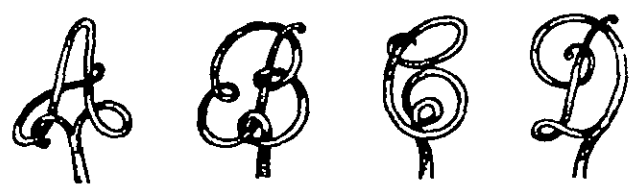

197

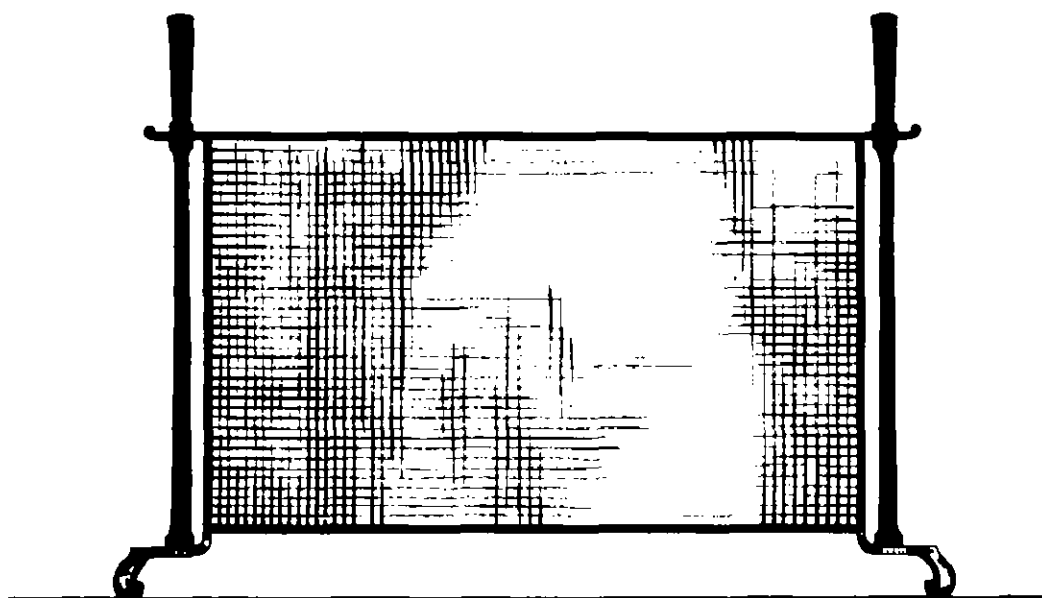

198

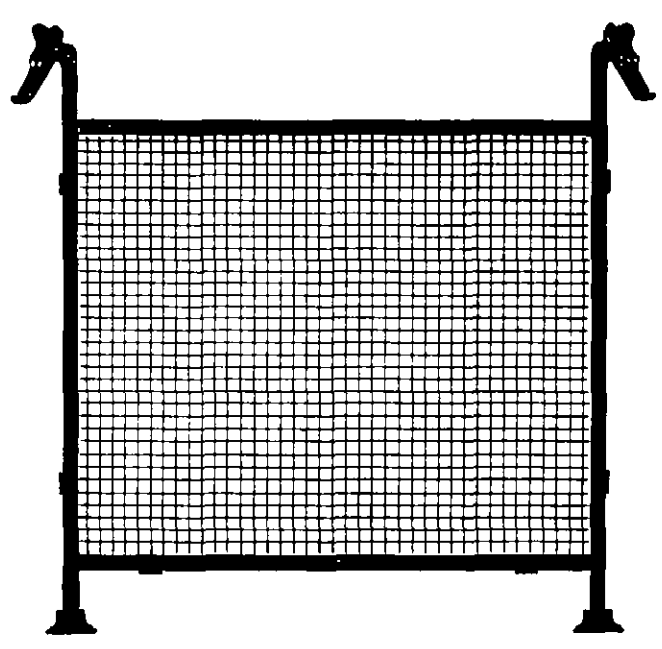

199

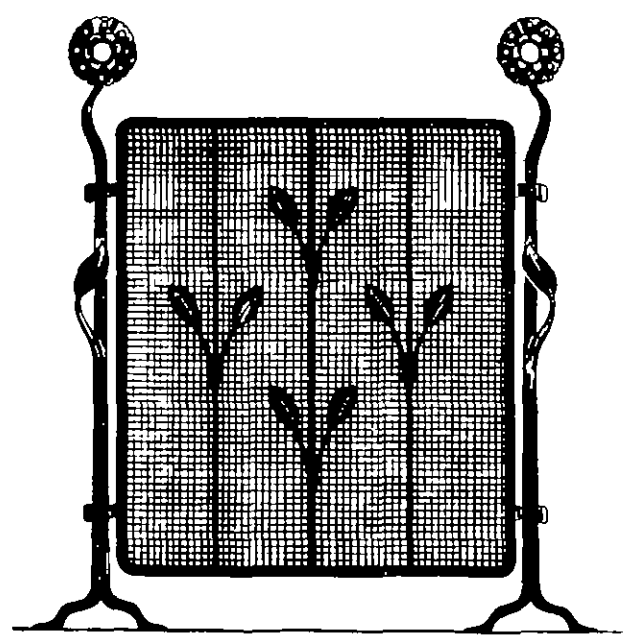

200

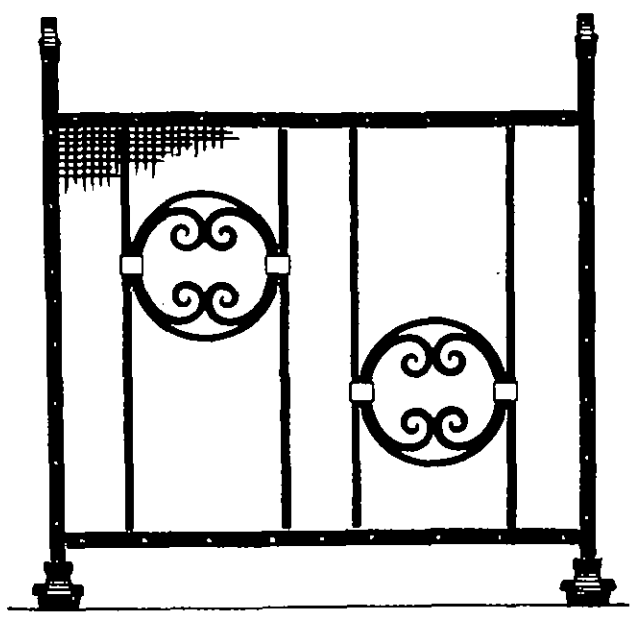

201

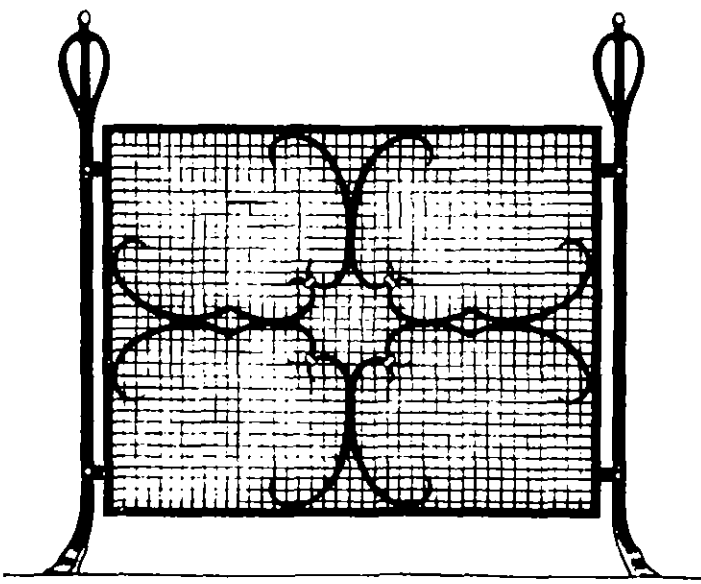

202

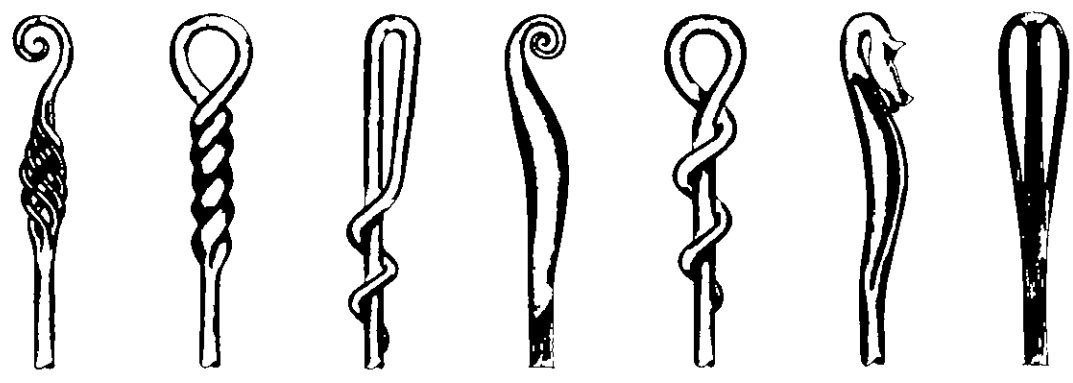
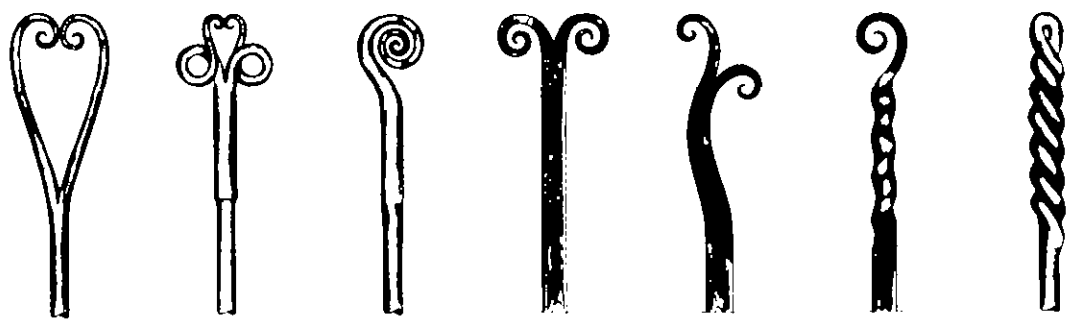



204



205



Lighting

300	1'0"	347	size as required	394	9½" × 7½" or 1'7" × 1'3"	
301	1'0½"	348	1'5"	395	7½" × 2½"	
302	8½"	349	11" × 7"	396	1'9" × 1'11½" high	
303	8"	350	9¾" × 4¼"	397	2'4" high	
304	11"	351	6"	398	2'1" or 4'2" high	
305	9½"	352	1'0"	399	2'1" or 4'2" high	
306	8¼"	353	3'7"	400	1'3¾" high	
307	1'5"	354	7" × 5"	401	2'6" long	
308	8"	355	3'1¼" × 7¾"	402	4" high	
309	1'5"	356	} 4'6"	403	1'6" high	
310	1'5"	357				
311	2'6" × 1'11"	358				
312	1'2"	359				
313	1'7"	360	8'0"			
314	1'6"	361	9'4"			
315	2'2¼"	362	10'3"			
316	2'4"	363	7'0½"			
317	1'8" × 11"	364	6'6"			
318	1'0"	365	4'2"			
319	7"	366	6'6"			
320	6½"	367	1'2"			
321	1'0½"	368	1'6⅛"			
322	11½"	369	1'4"			
323	1'0"	370	1'0¾"			
324	1'3"	371	9"			
325	3'10"	372	1'10"			
326	1'6" dia.	373	3'5"			
327	2'2" dia.	374	8¾"			
328	1'4"	375	5½"			
329	1'9½"	376	5'7"			
330	2'10"	377	5'9½"			
331	2'1" dia.	378	5'11½"			
332	2'0" dia.	379	5'9½"			
333	2'0"	380	4½" × 6" dia.			
334	2'9" dia.	381	1'1"			
335	1'0"	382	5½"			
336	11½" × 5"	383	6'0"			
337	7" × 3"	384	4½"			
338	11"	385	3'1½"			
339	7" × 4"	386	6"			
340	1'9" × 3½"	387	4½"			
341	1'4" × 4"	388	3'0" × 5½"			
342	9"	389	1'0"			
343	1'5" × 10"	390	6½"			
344	10" × 5"	391	3'3" long			
345	size as required	392	1'7¾" high			
346	10"	393	1'3" × 8¾" high			

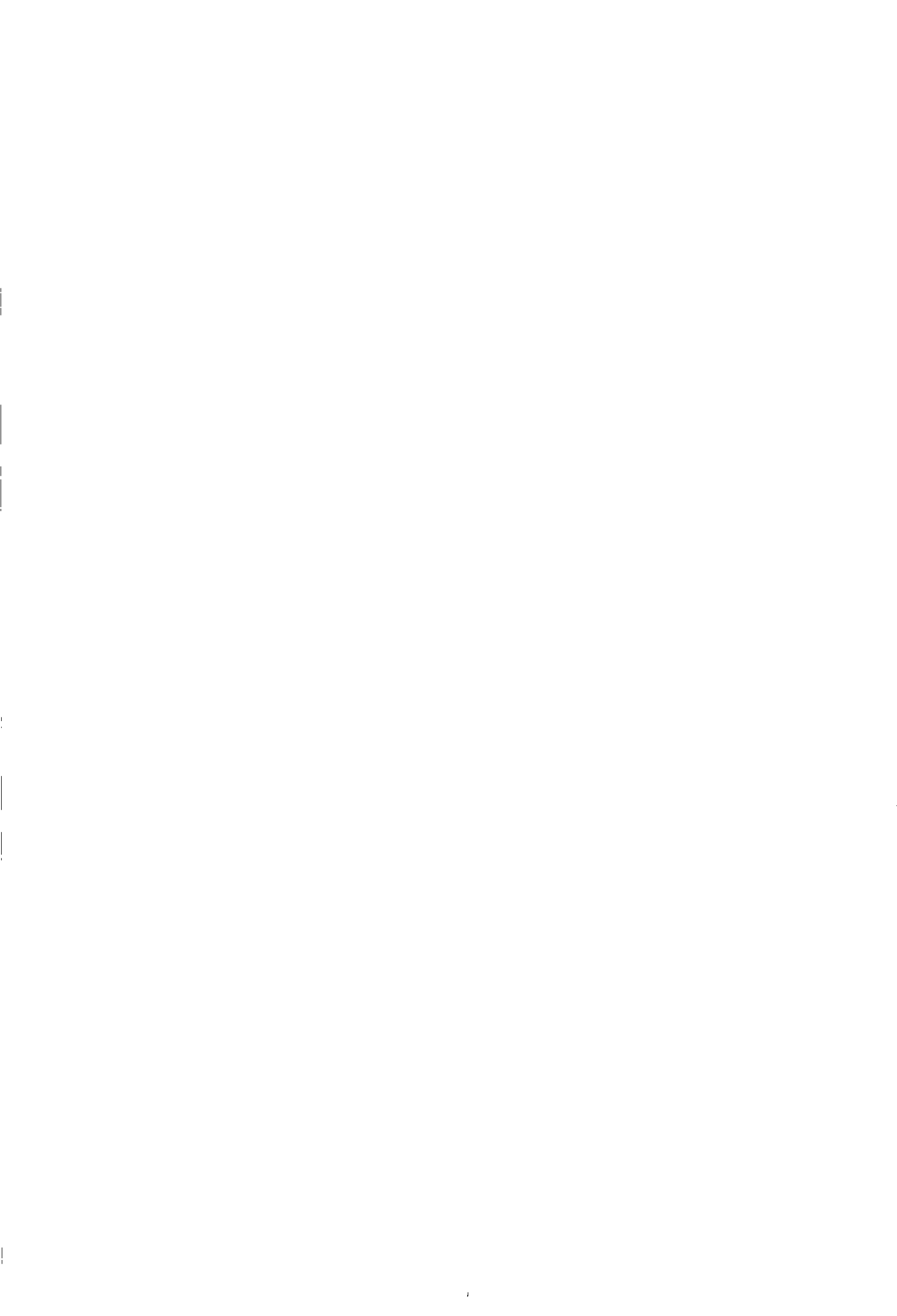

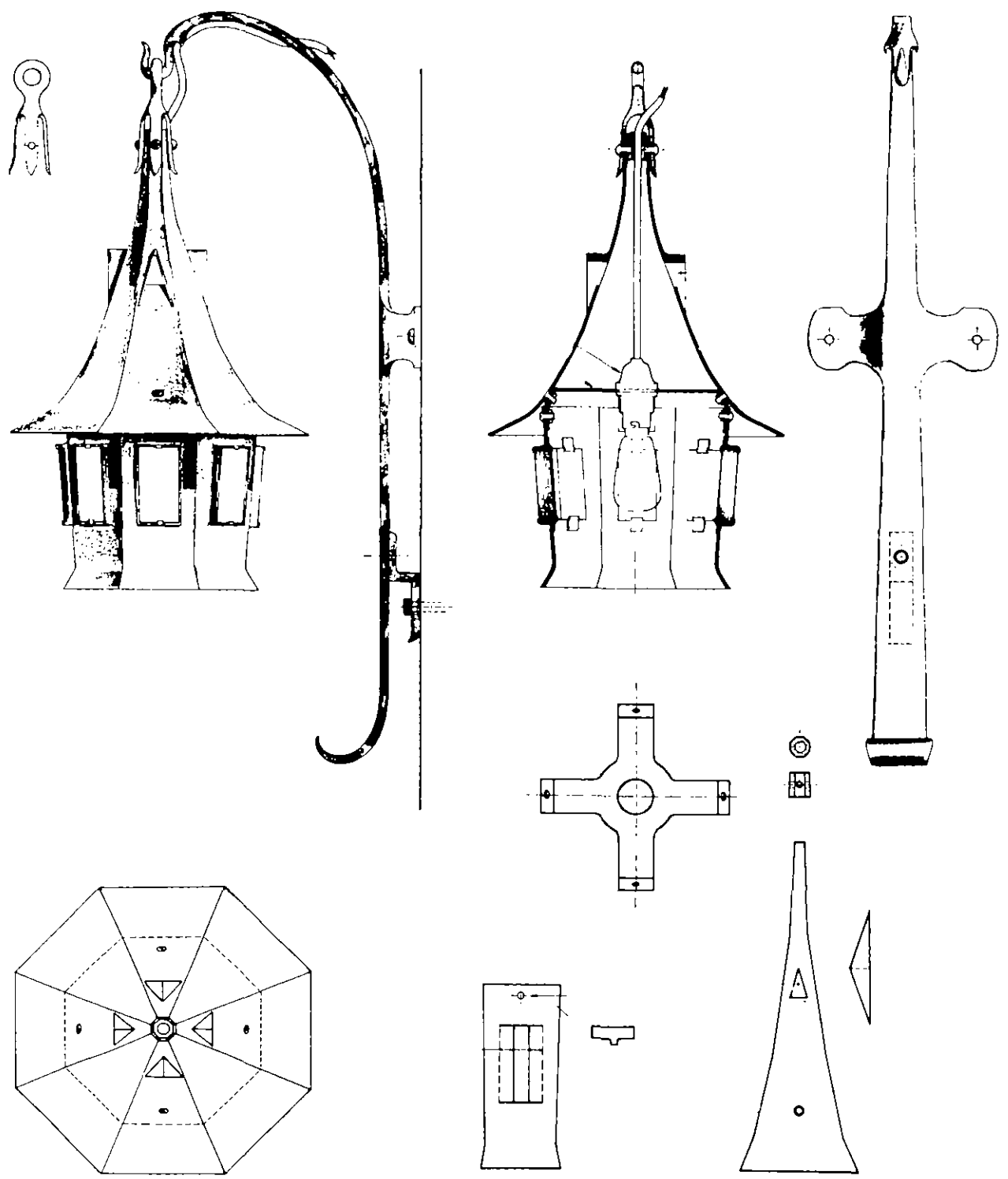



301

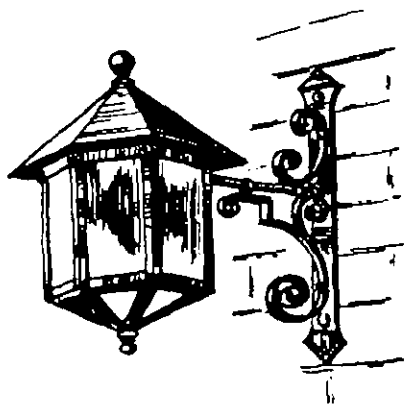

304

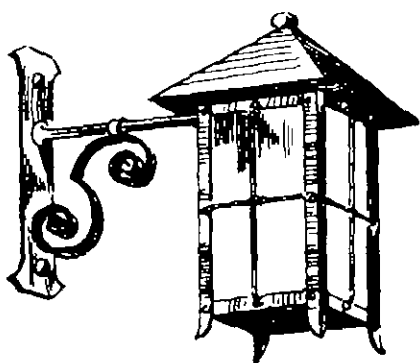

302

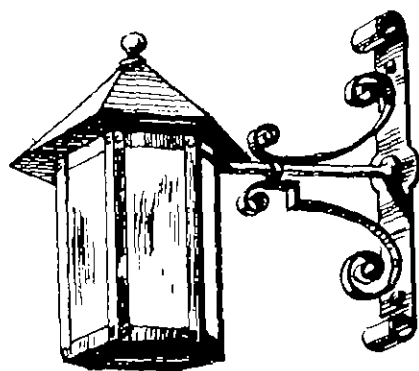

305

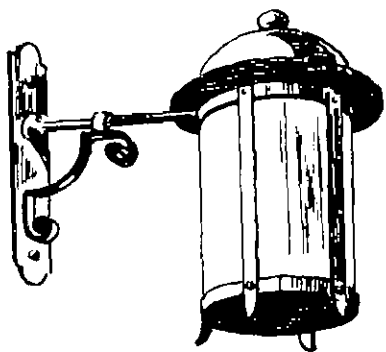

303

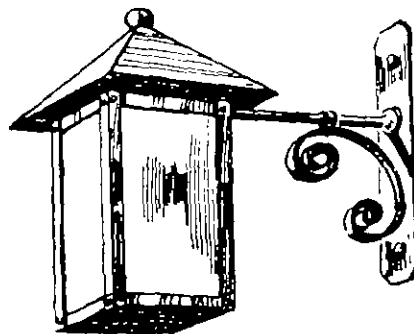

306

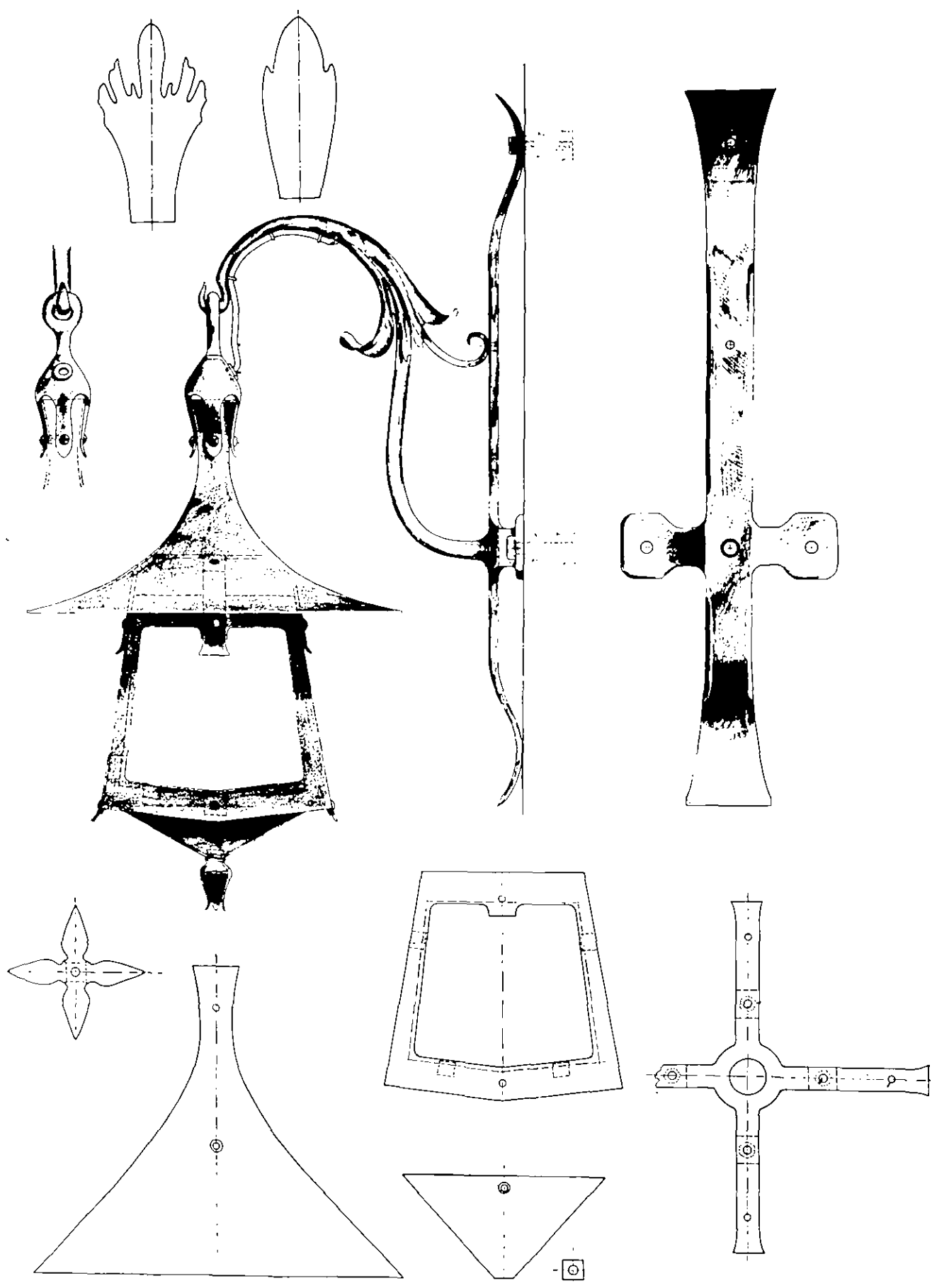

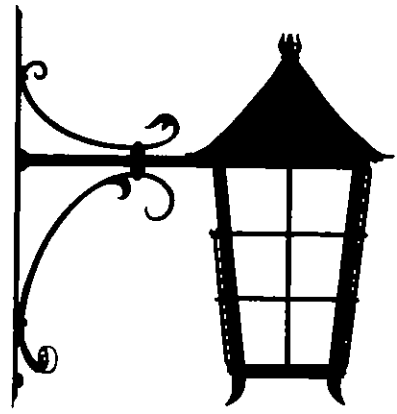

309

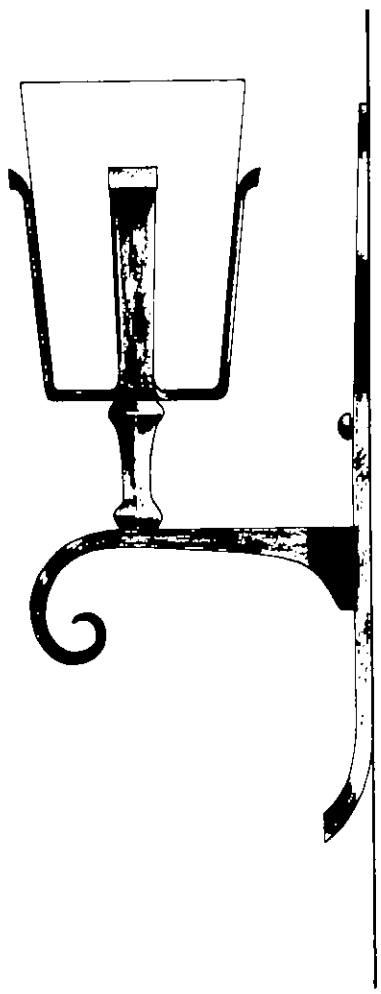

308

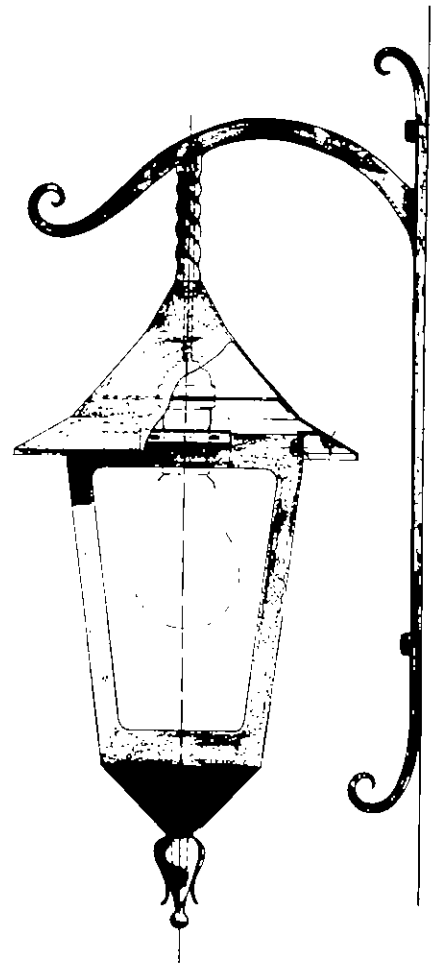

310



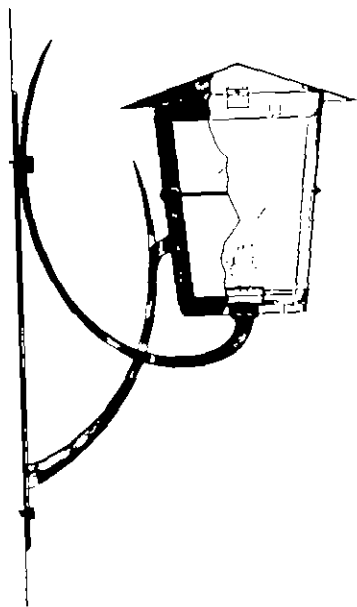

312

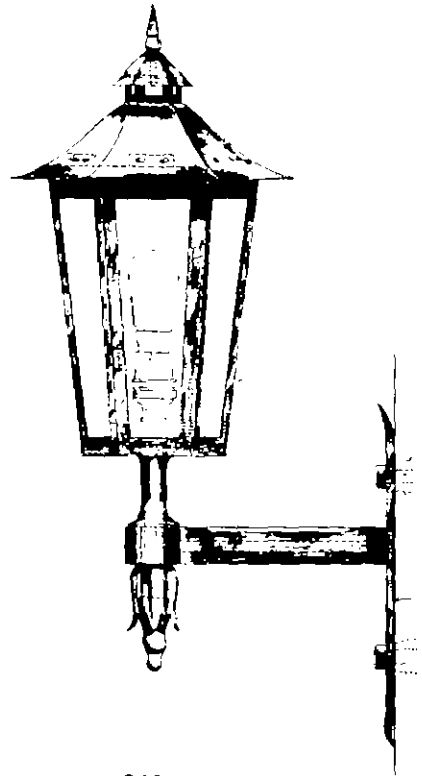

313

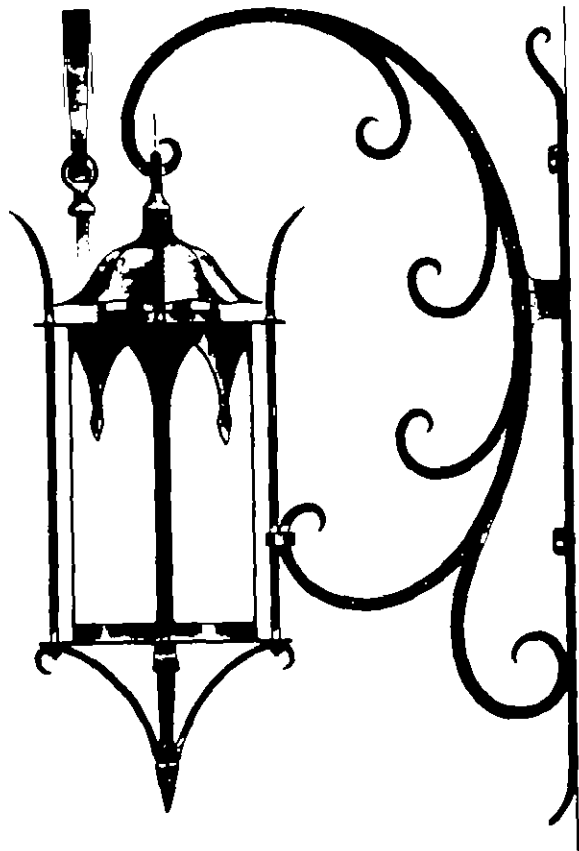

314

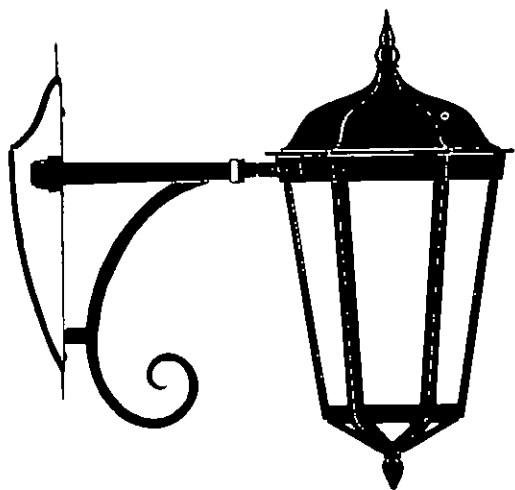

315

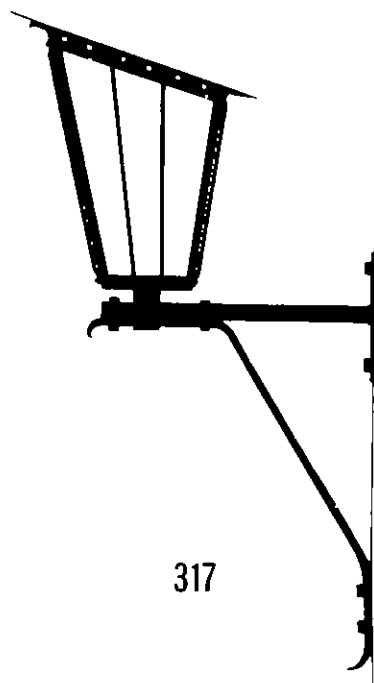

317

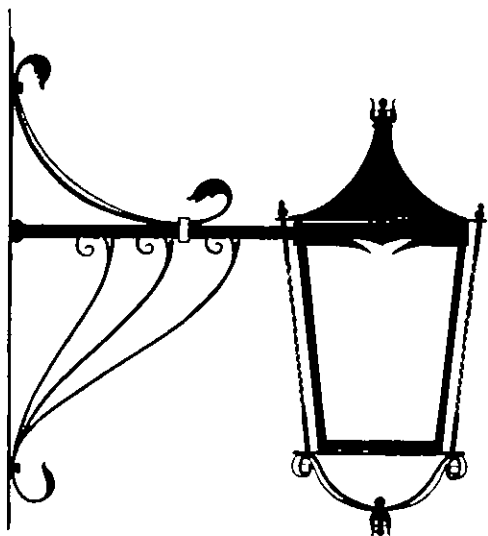

316

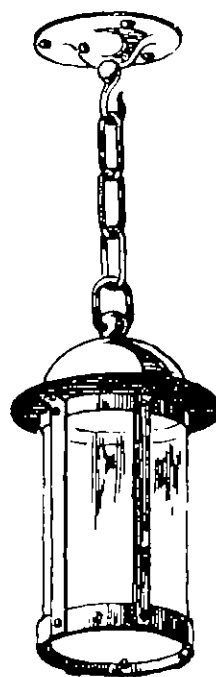

318

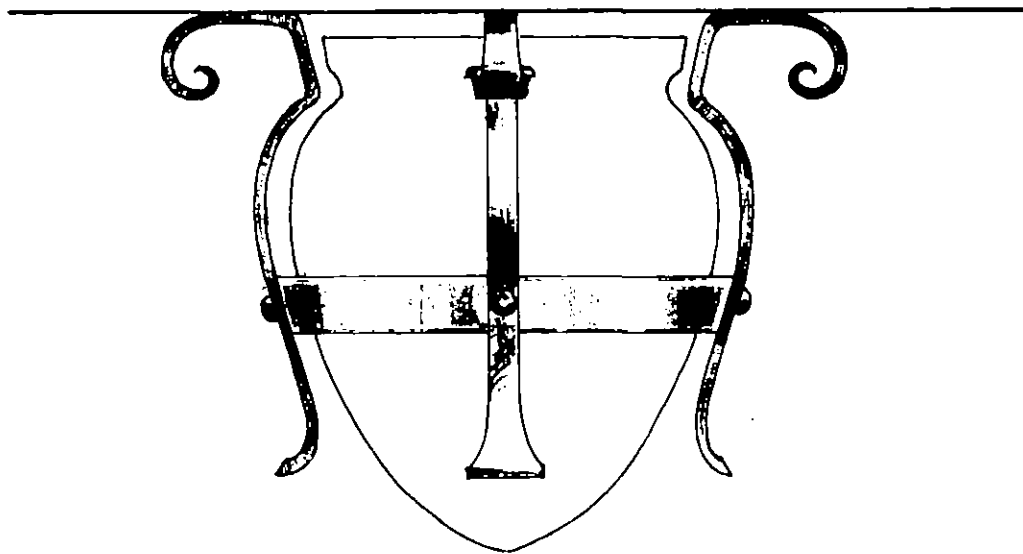

319

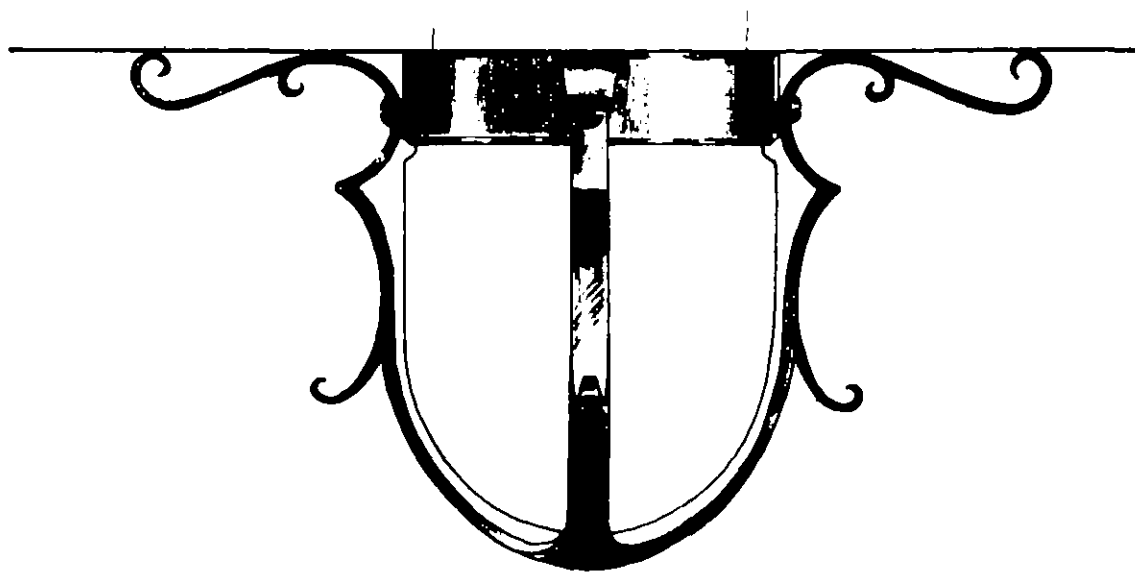

320

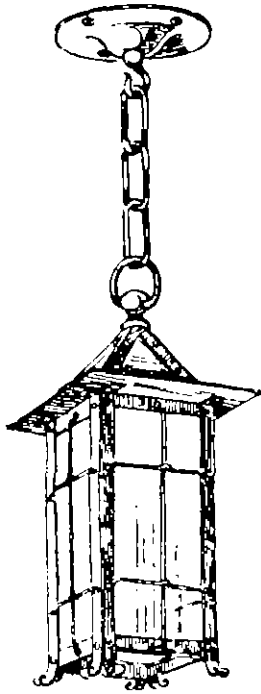

321

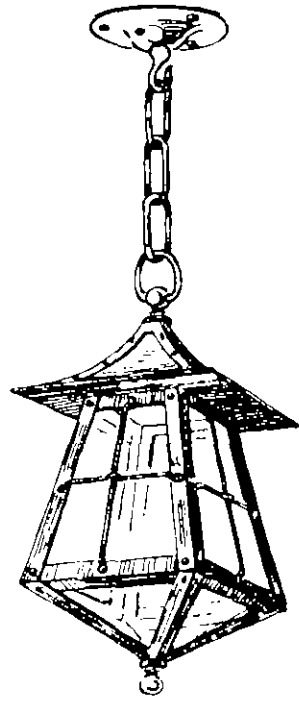

323

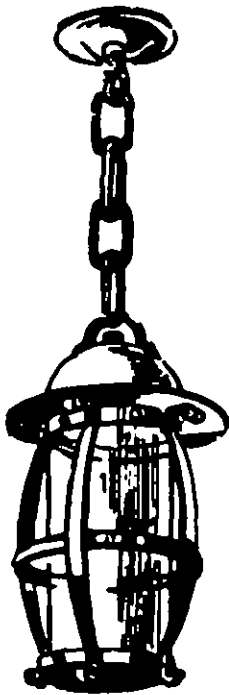

322

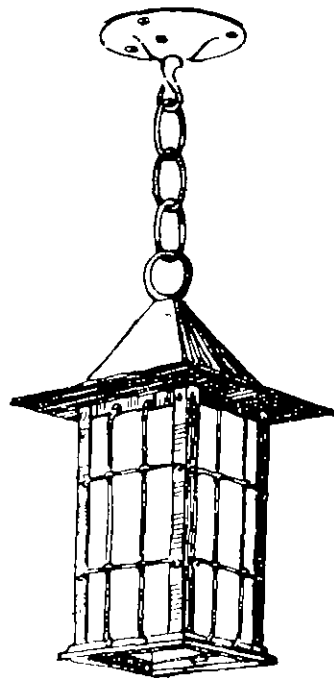

324

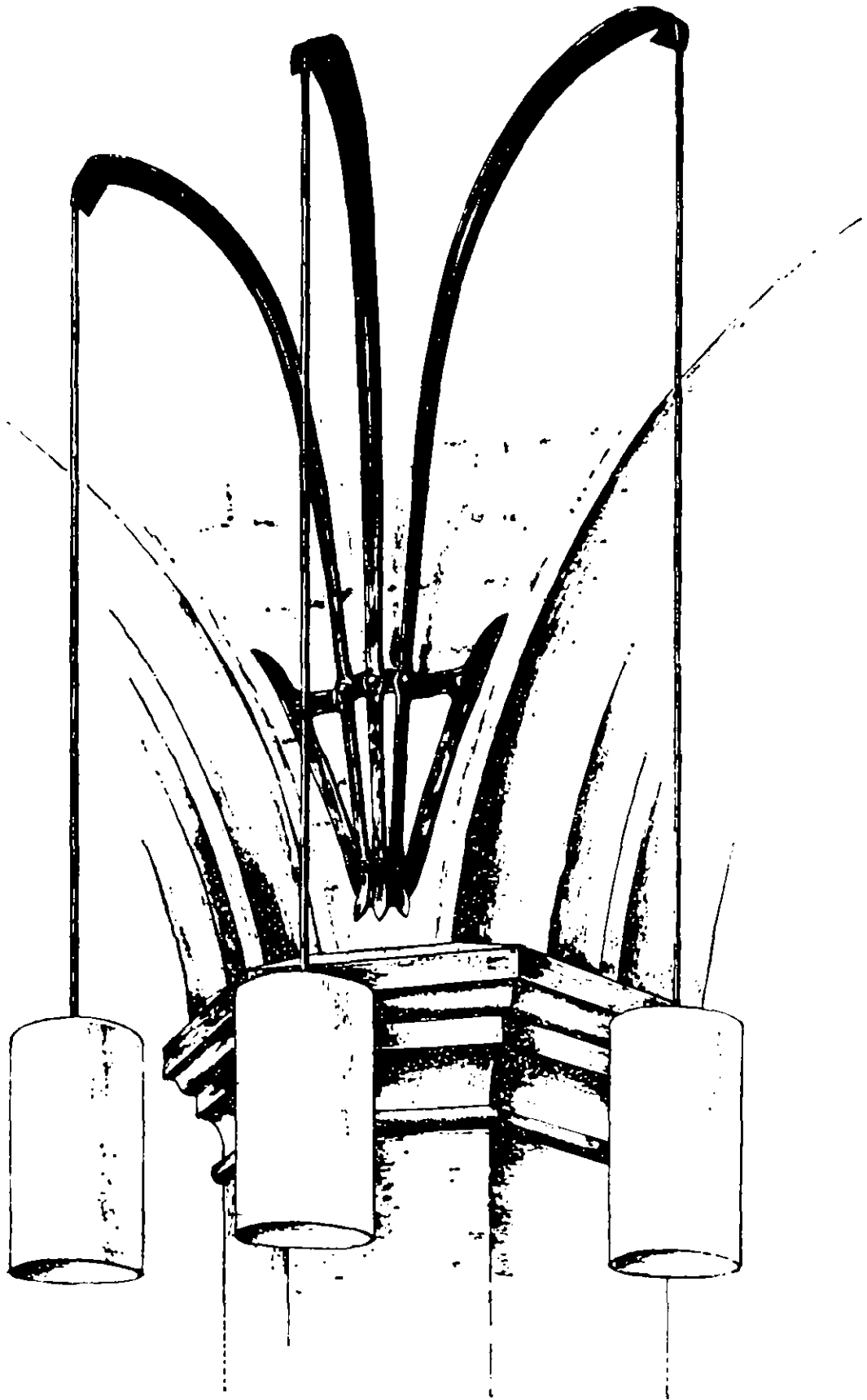

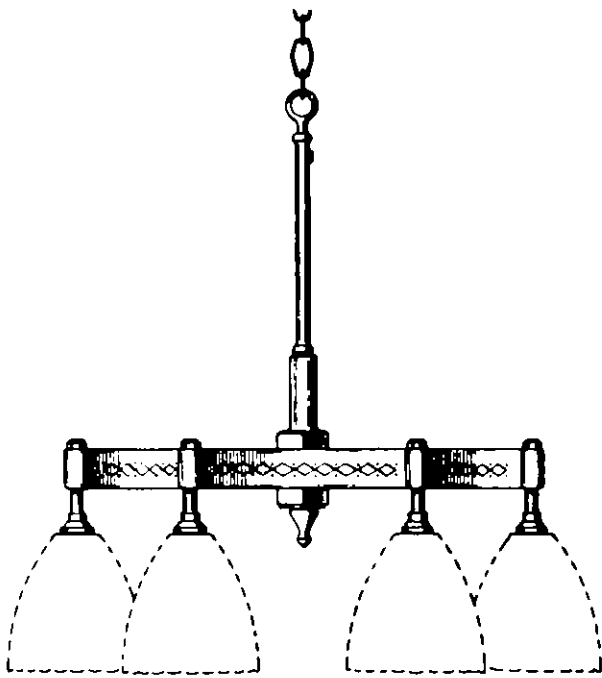

326

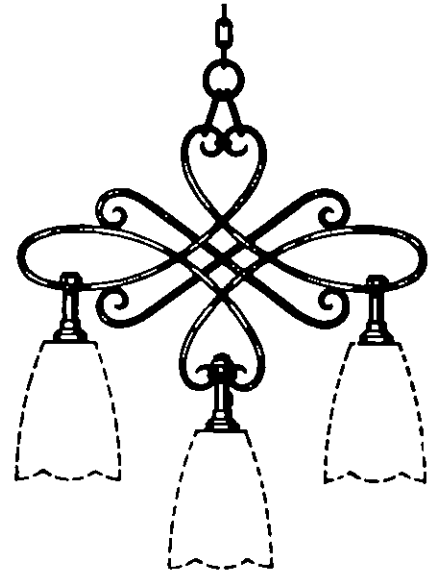

328

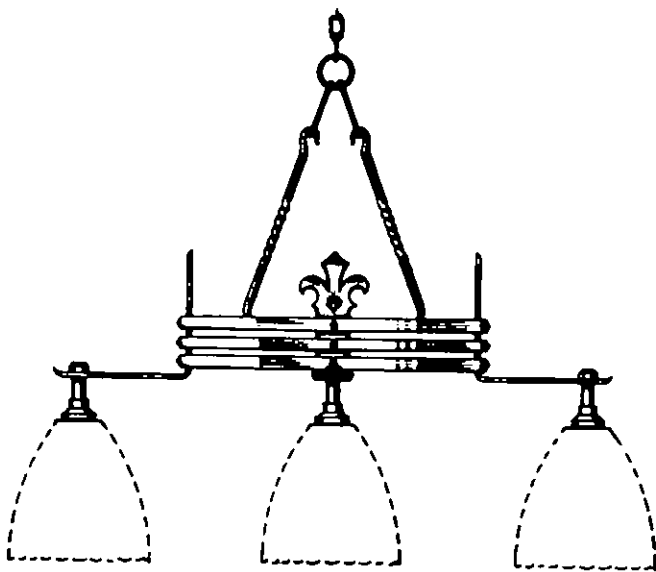

327

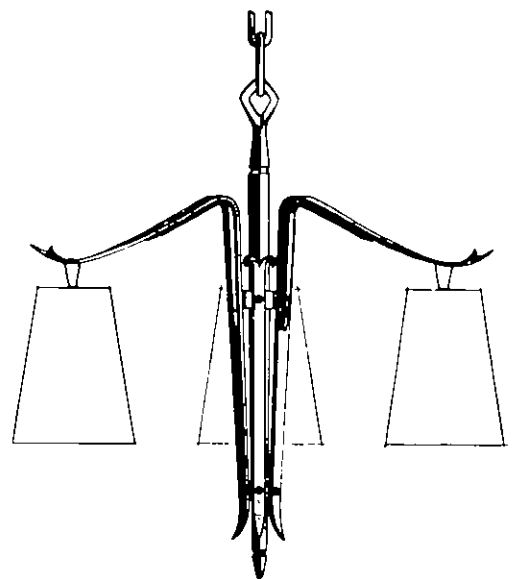

329

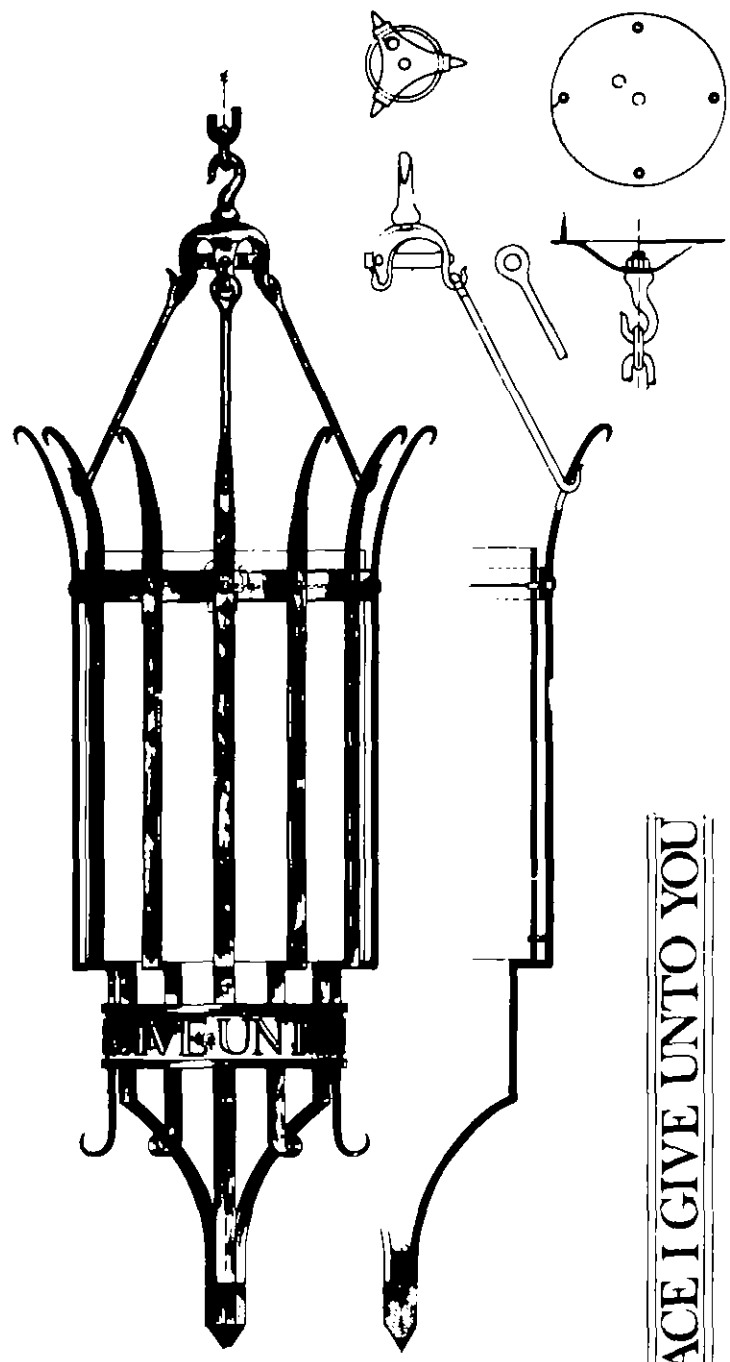

·MY PEACE I GIVE UNTO YOU

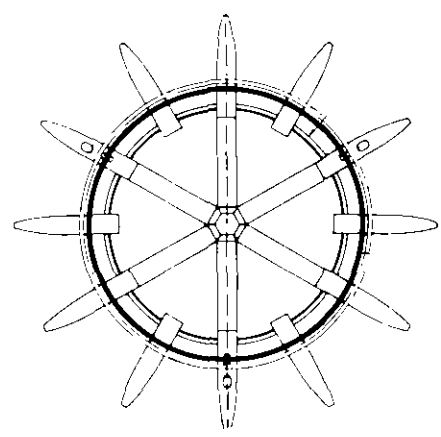

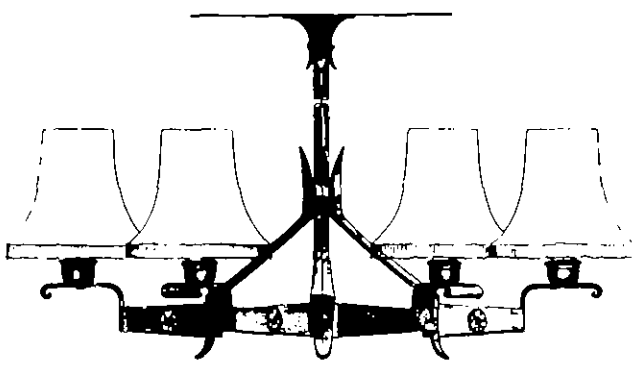

331

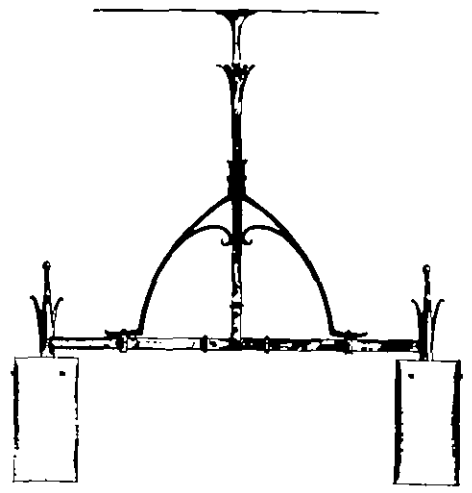

333

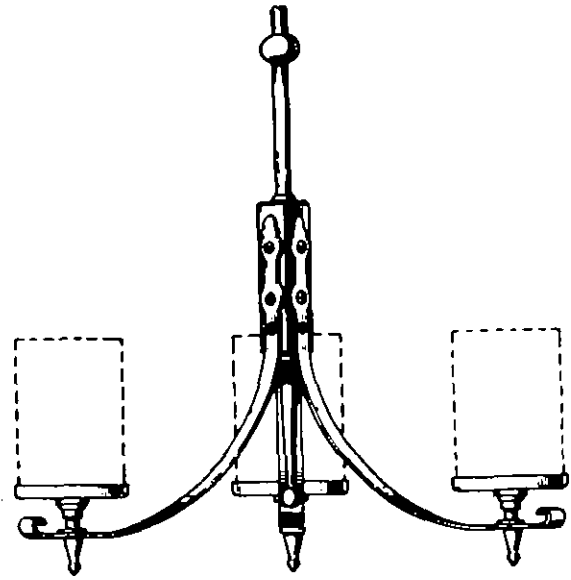

332

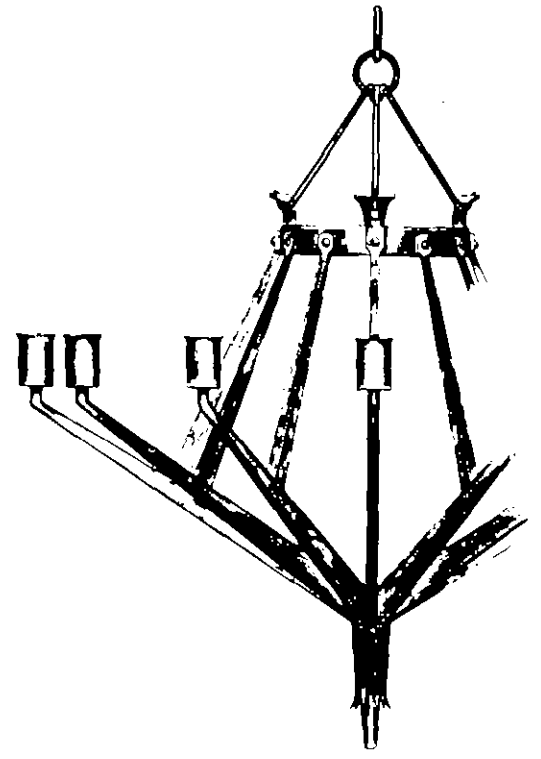

334

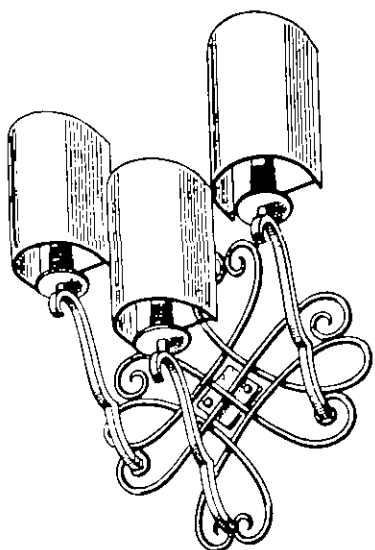

335

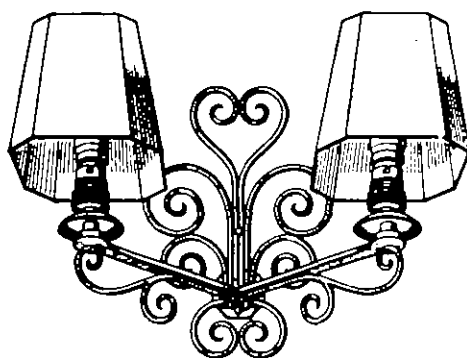

338

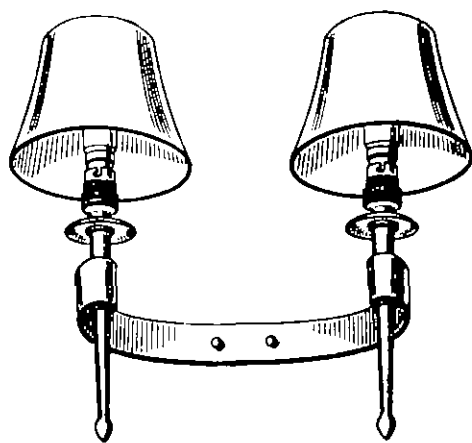

336

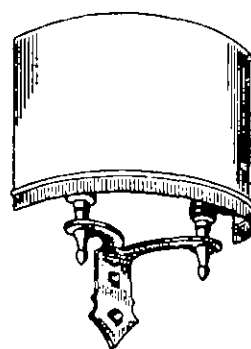

339

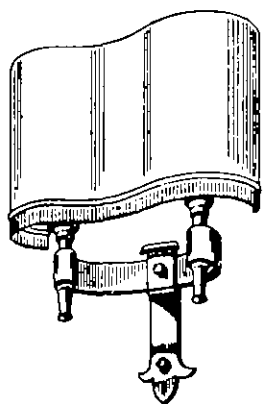

337

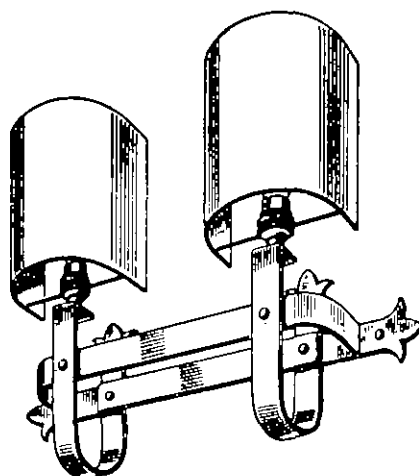

340

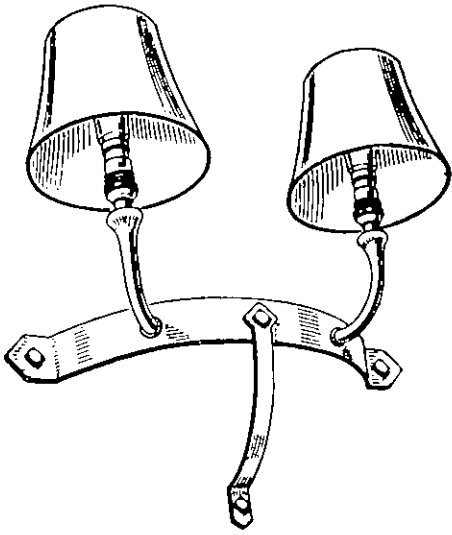

341

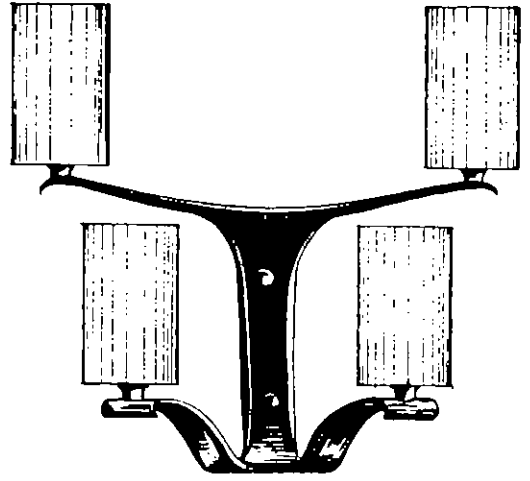

343

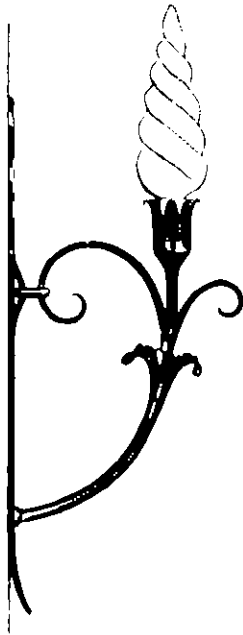

342

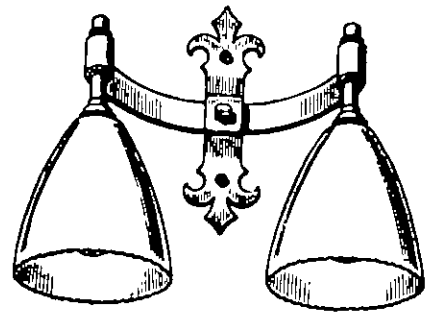

344

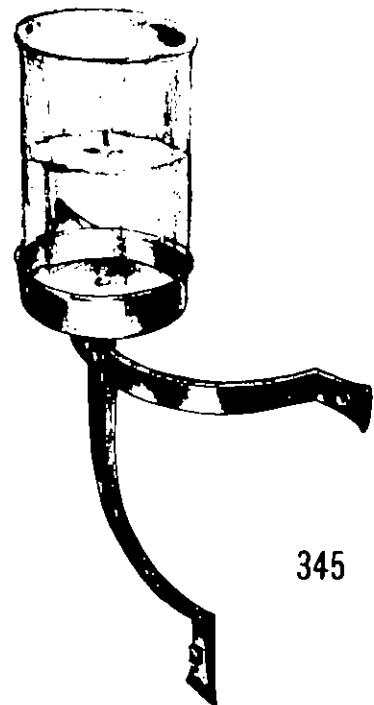

345

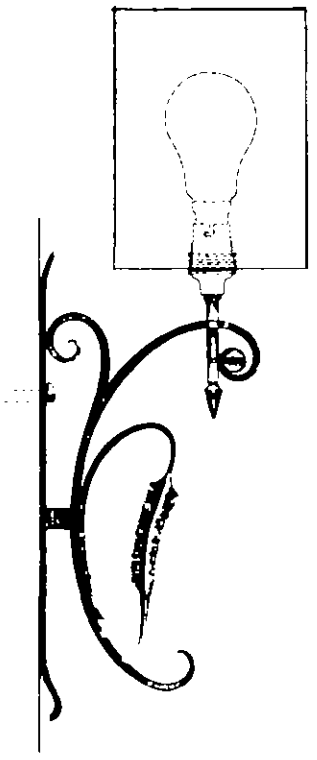

346

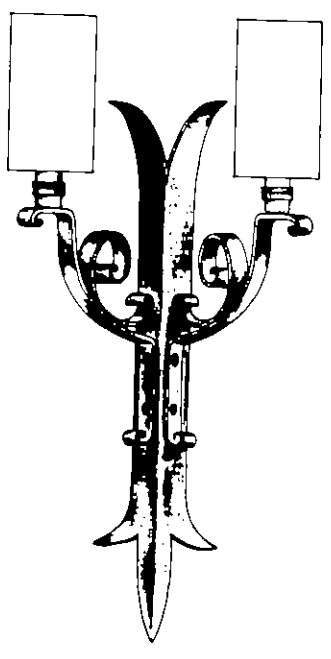

348



347

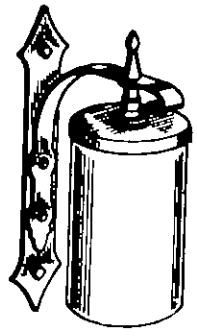

349

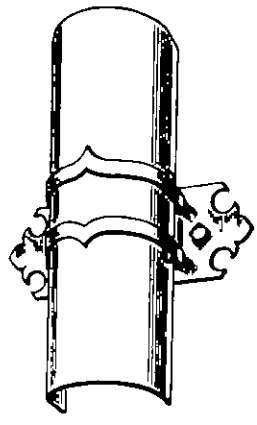

350

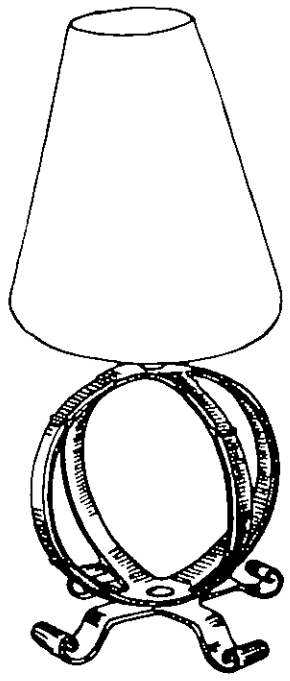

351

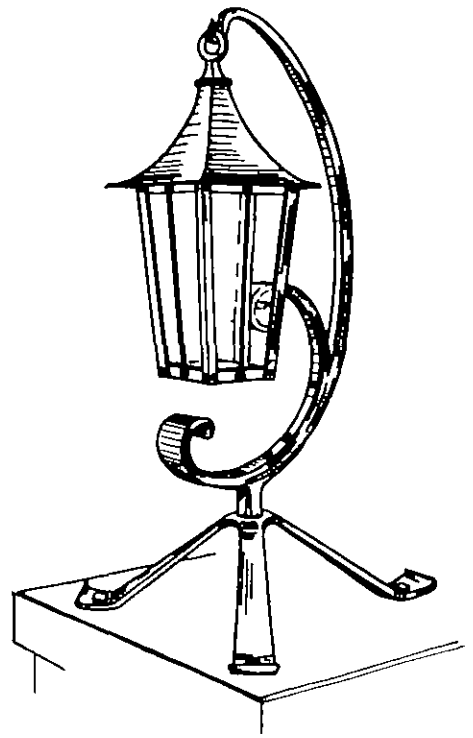

353

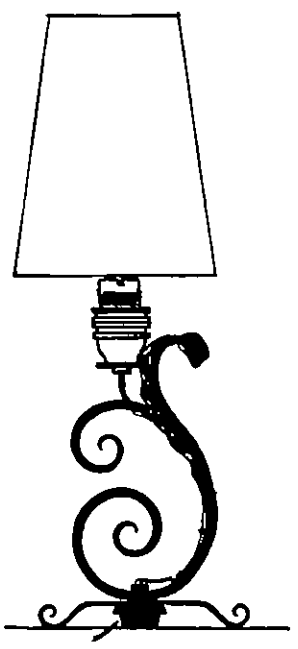

352

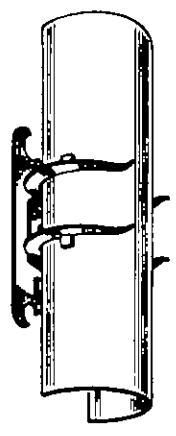

354

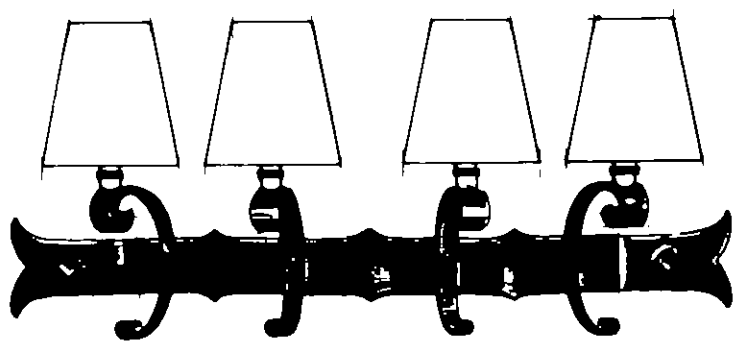

355

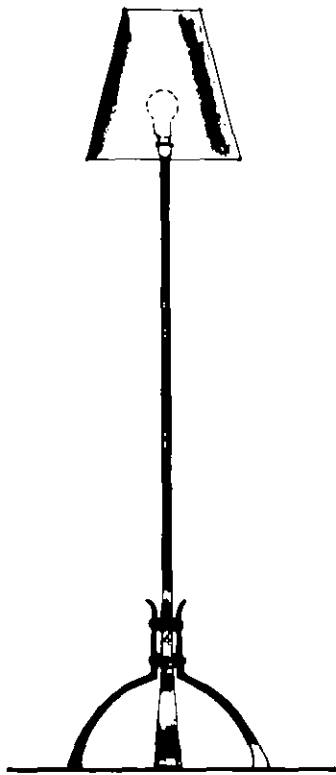

356

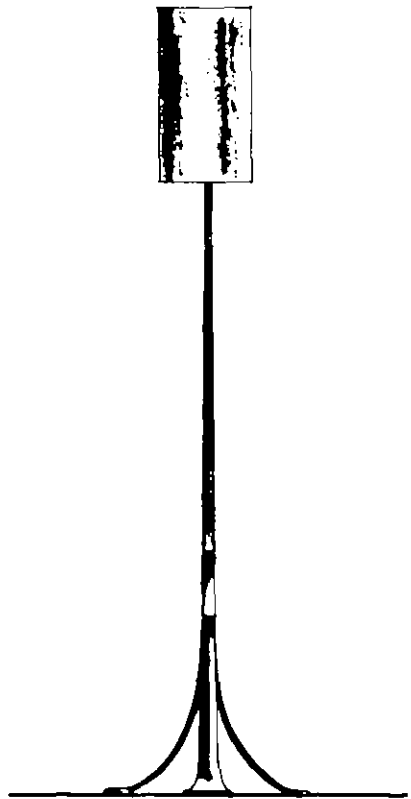

358

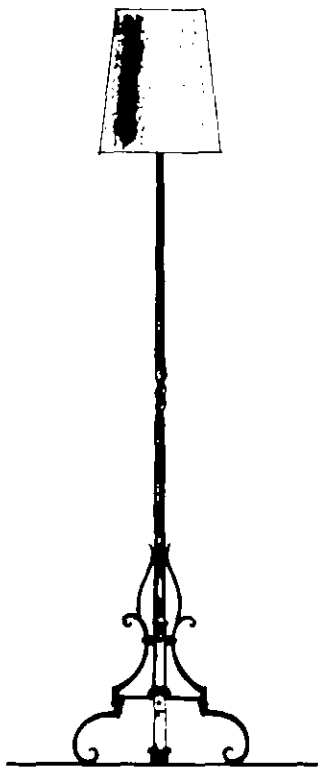

357

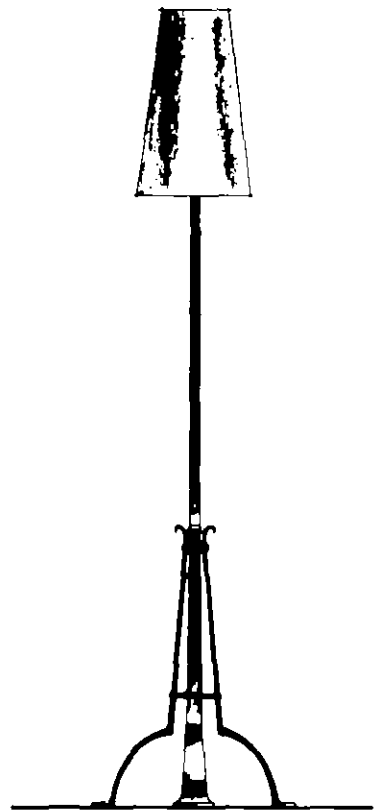

359

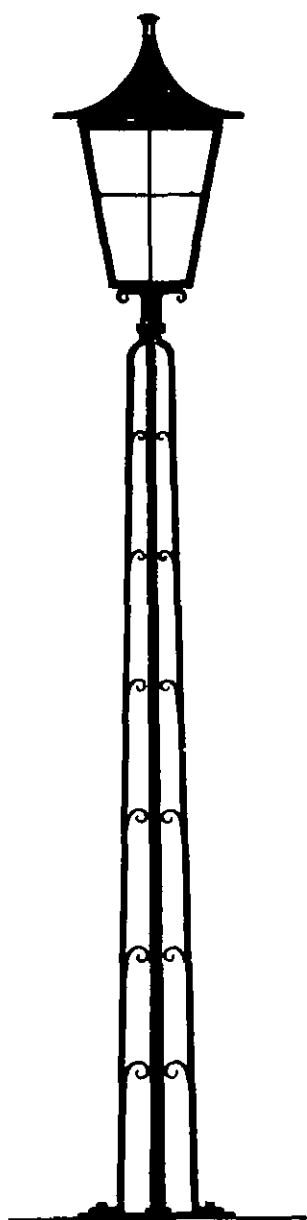

360

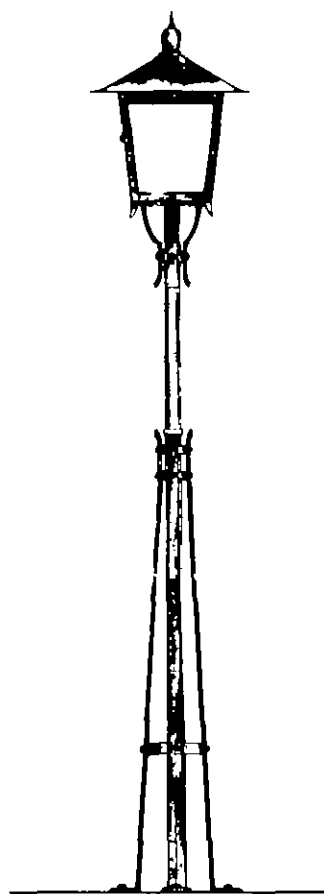

361

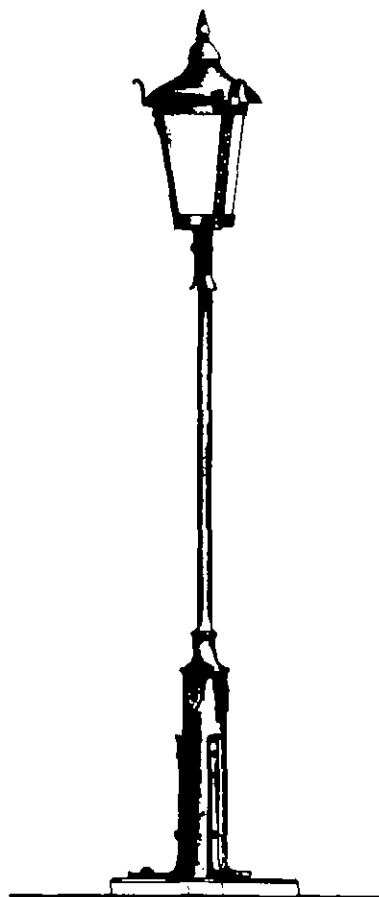

362

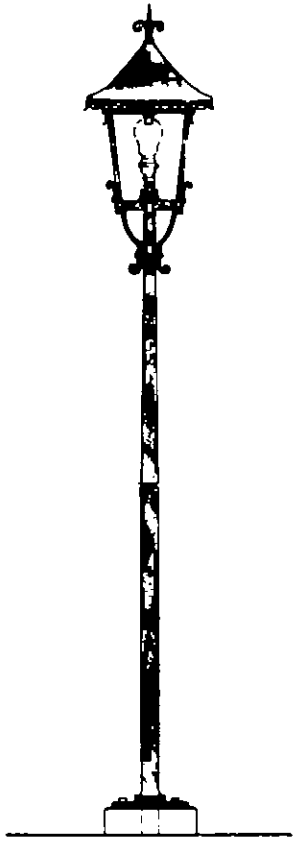

363

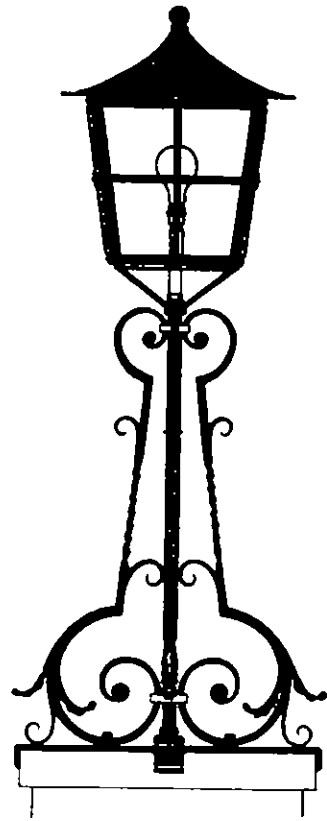

365

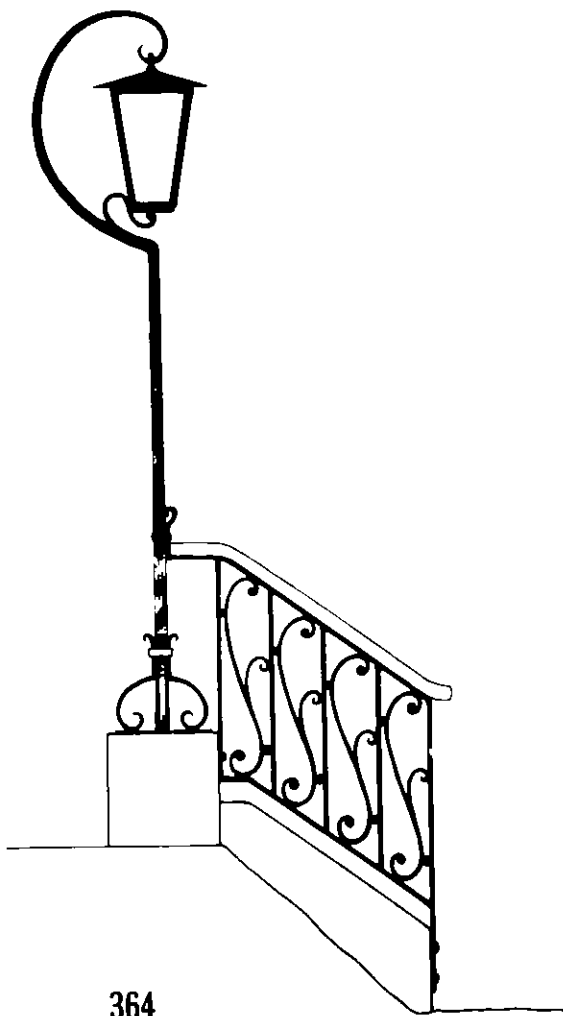

364

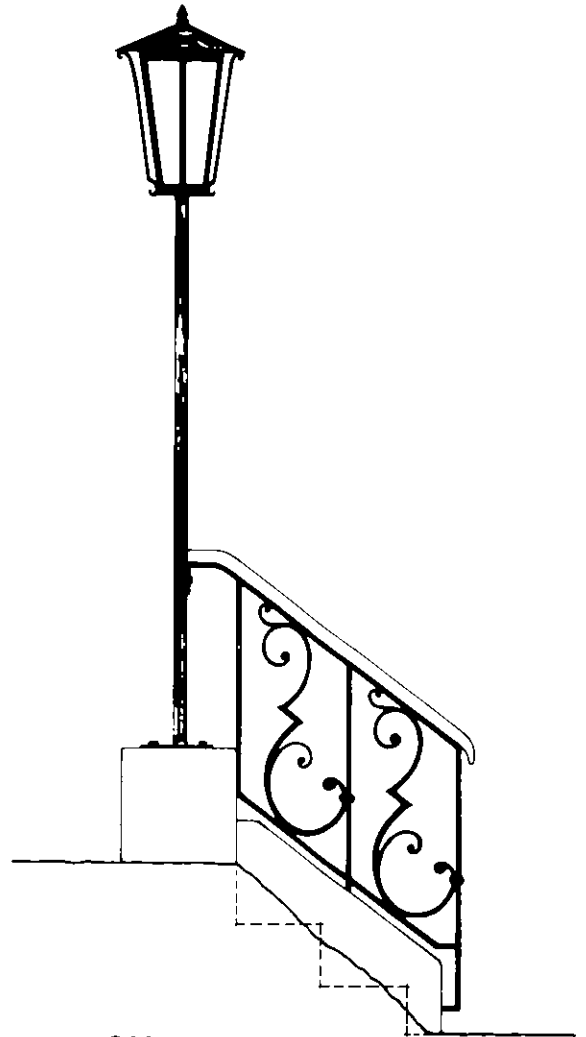

366

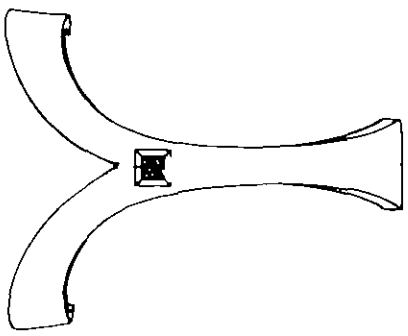
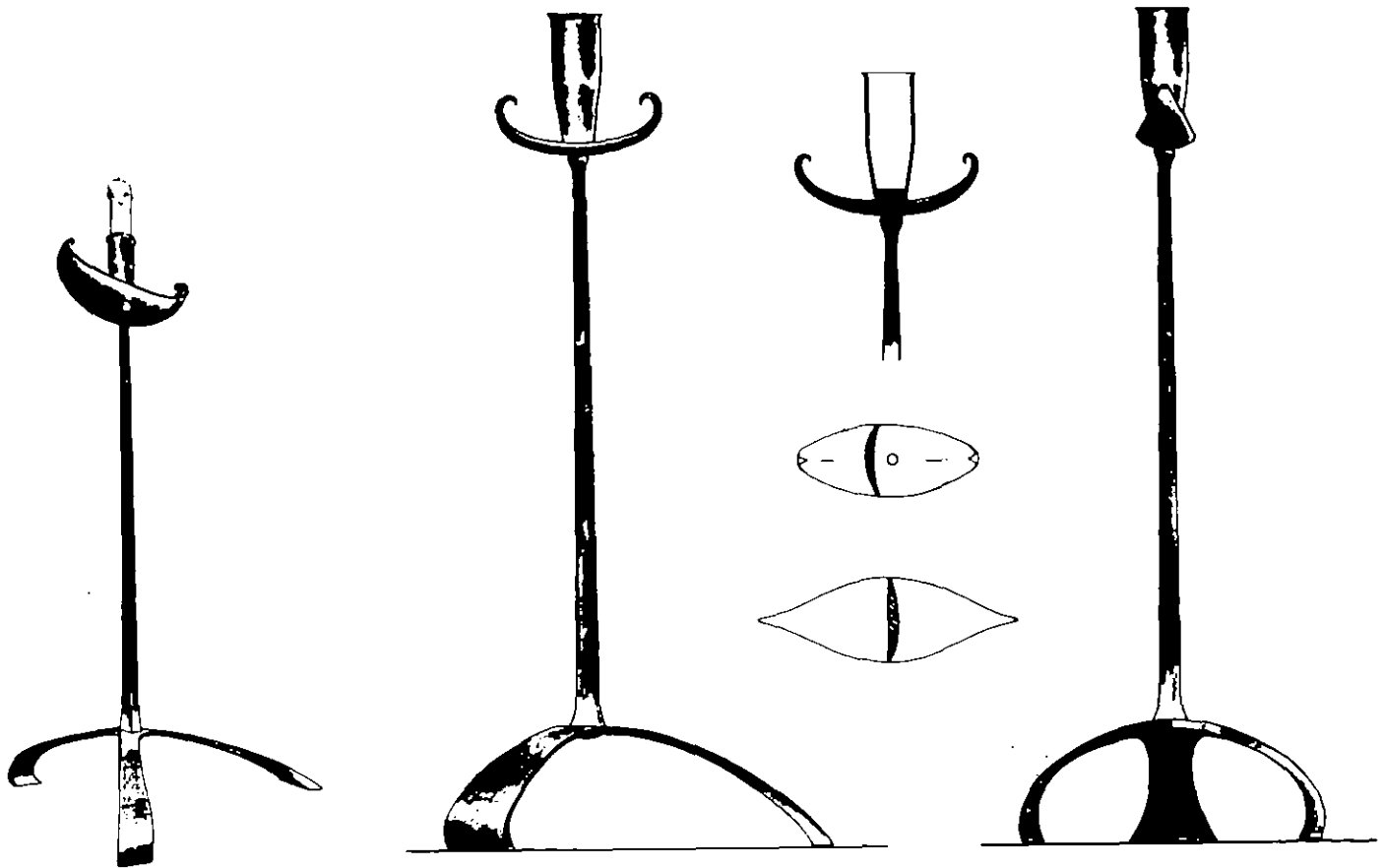

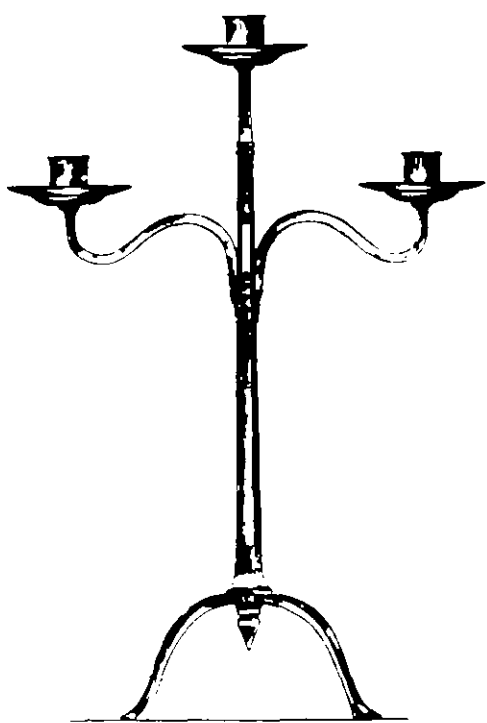

368

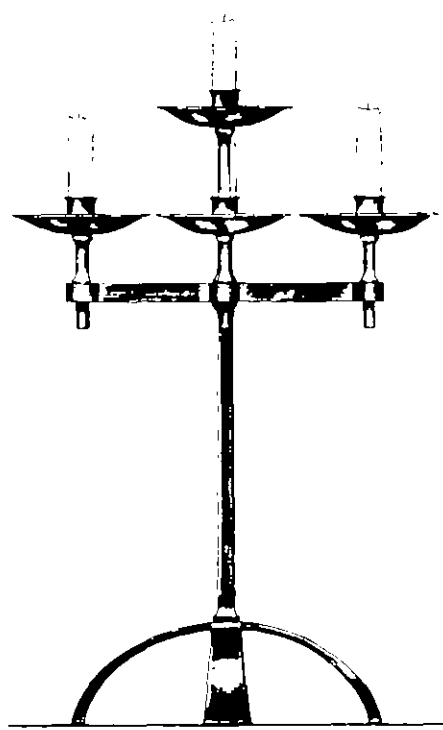

370

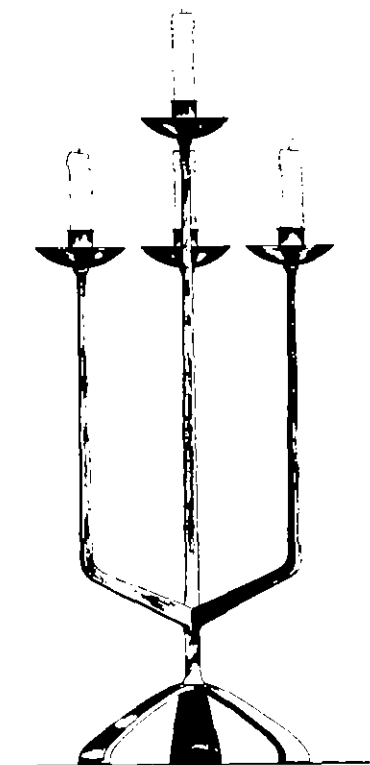

369

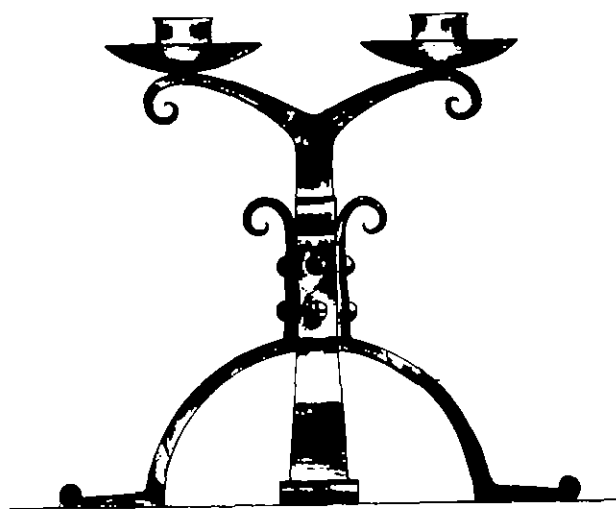

371

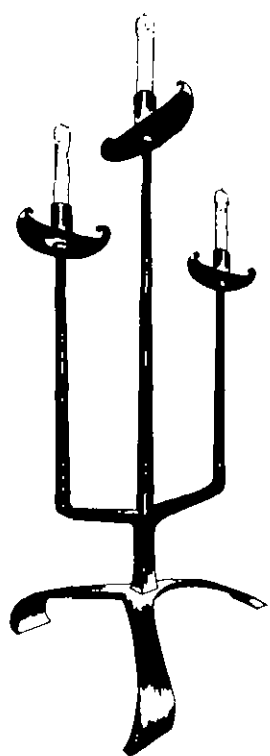

372

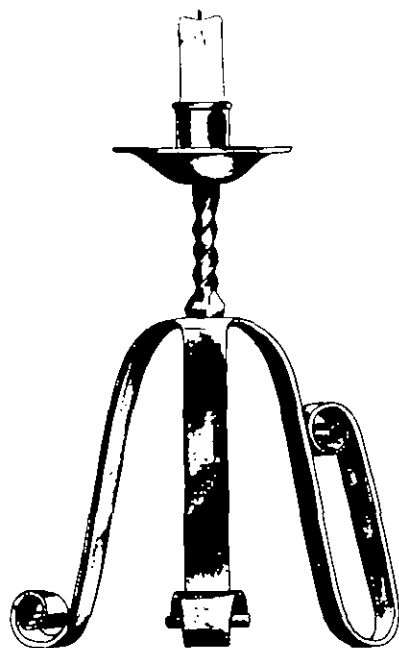

374

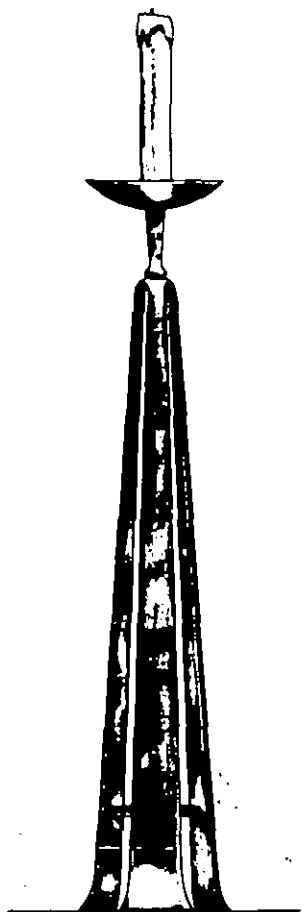

373

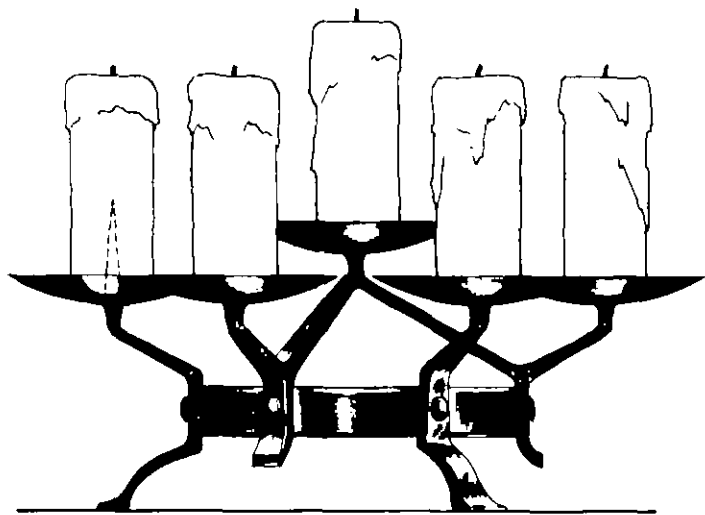

375

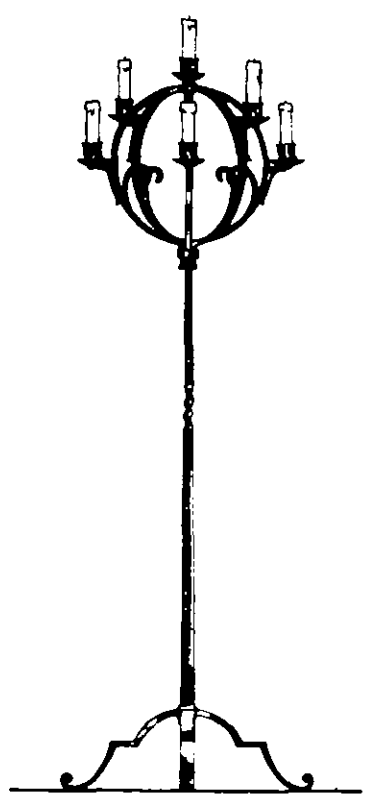

376

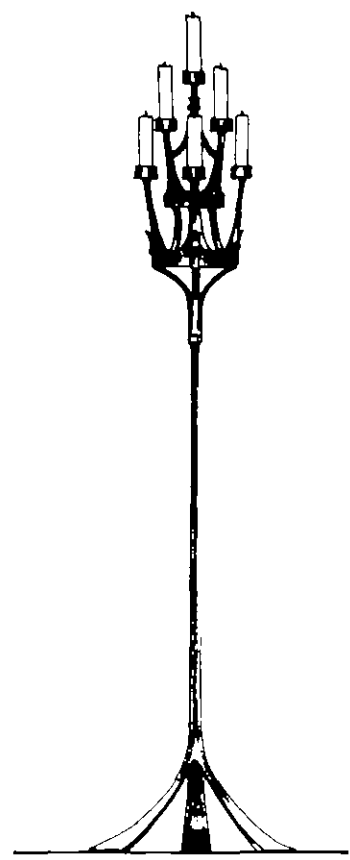

378

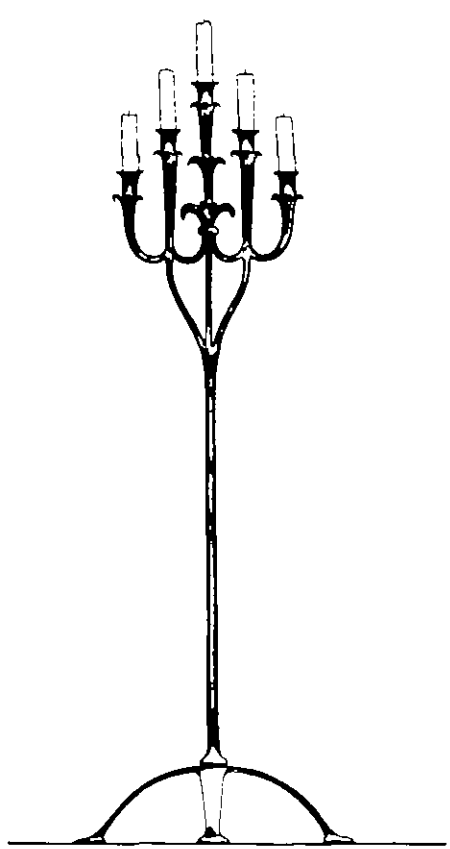

377

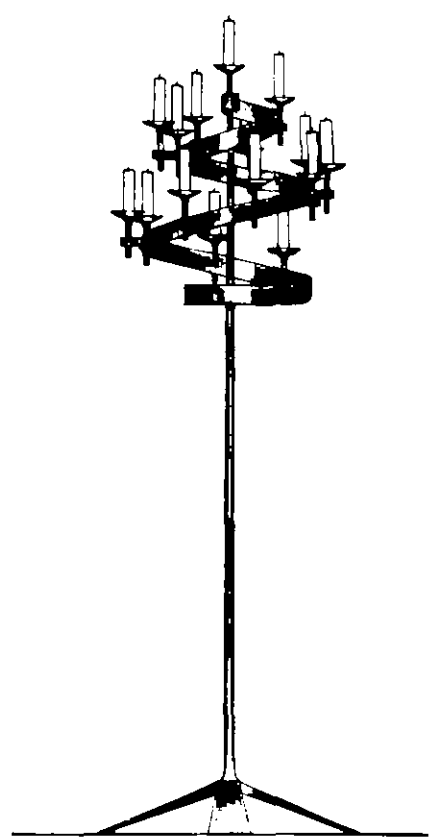

379

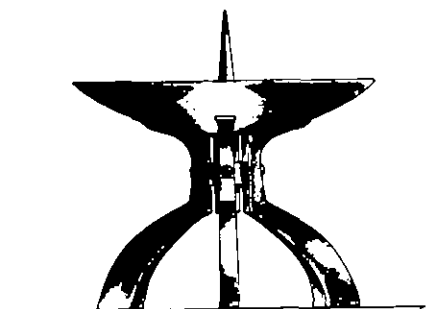

380

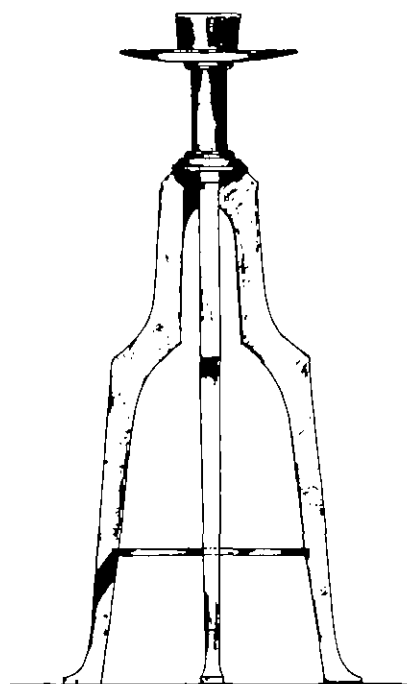

381

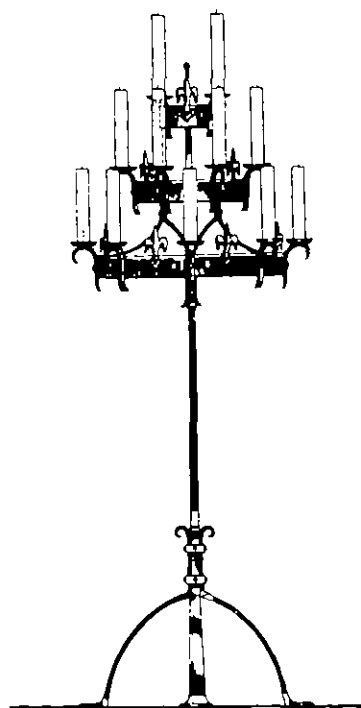

383

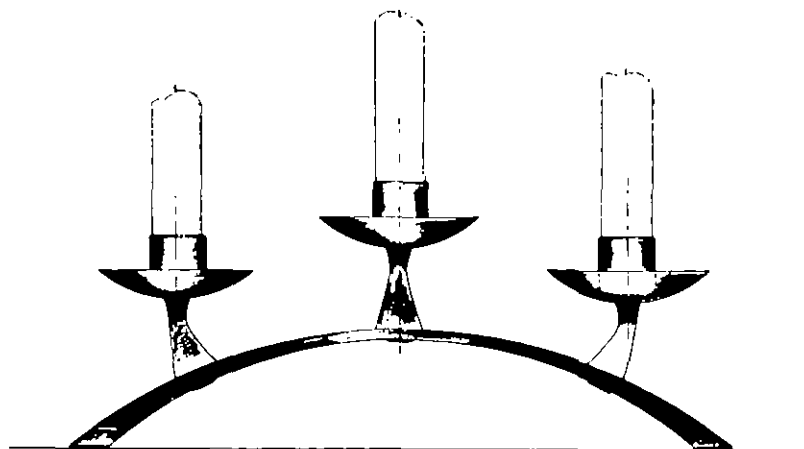

382

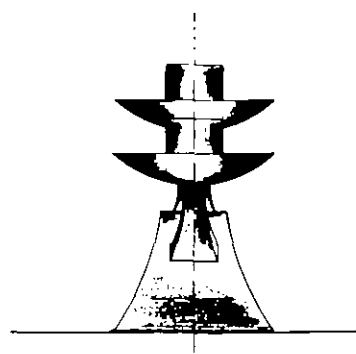

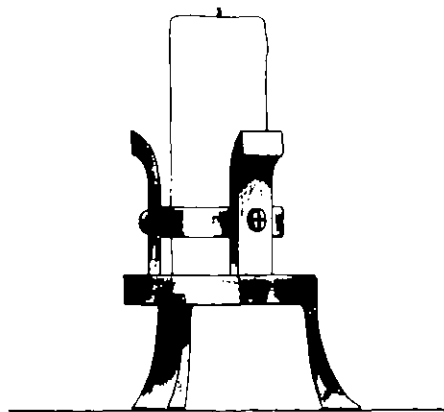
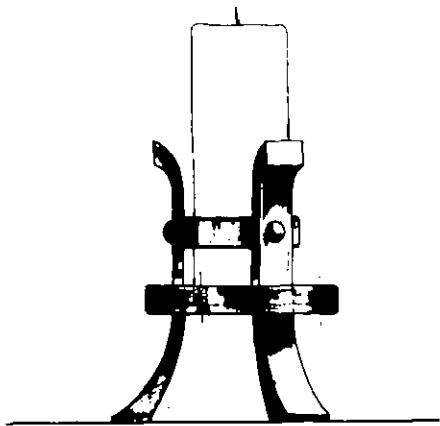

384

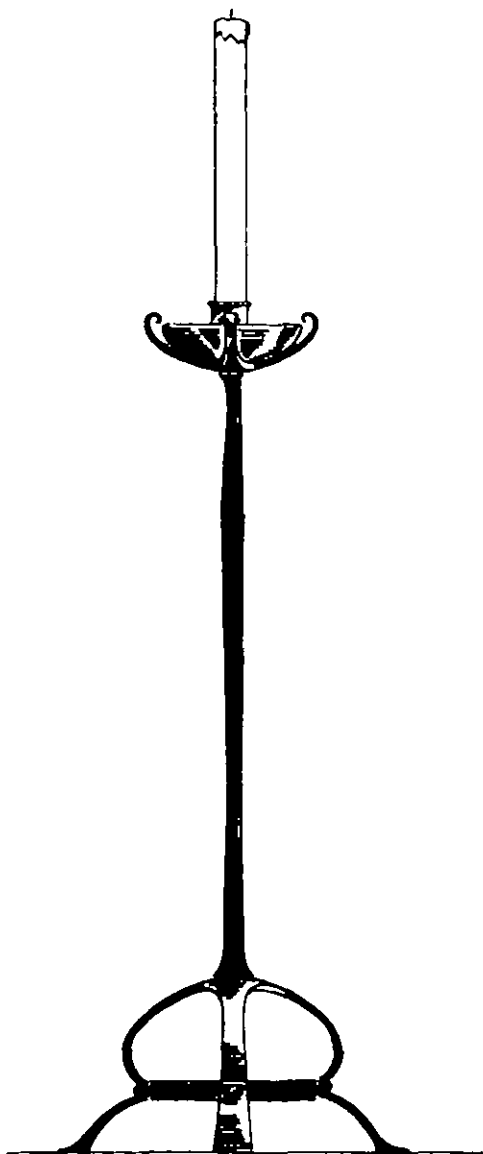

385

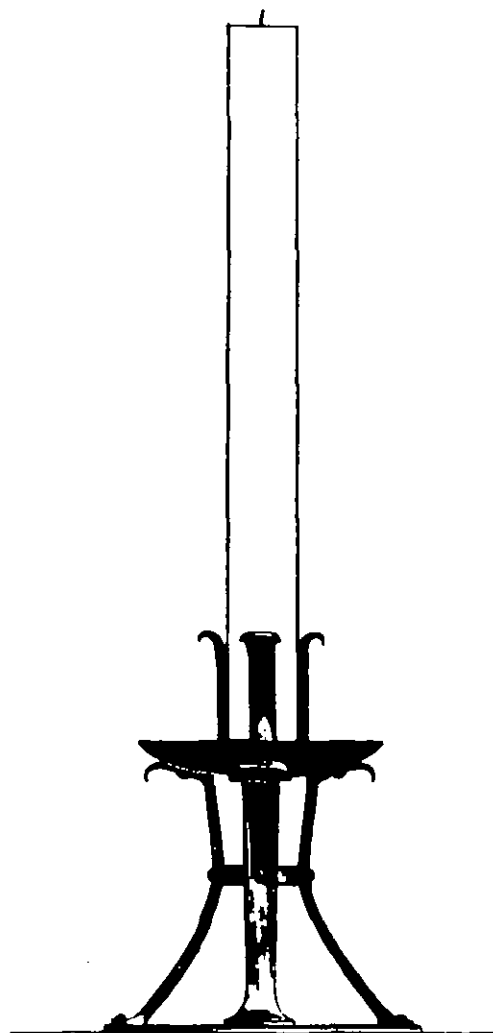

386

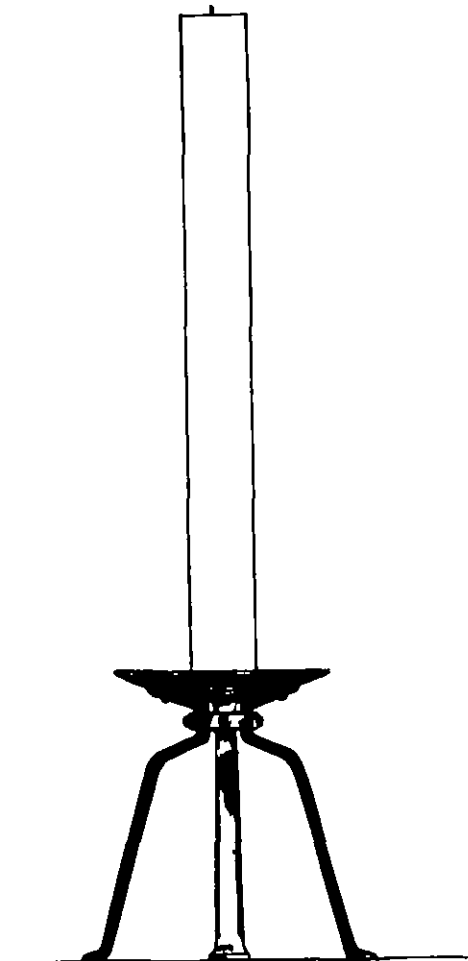

387

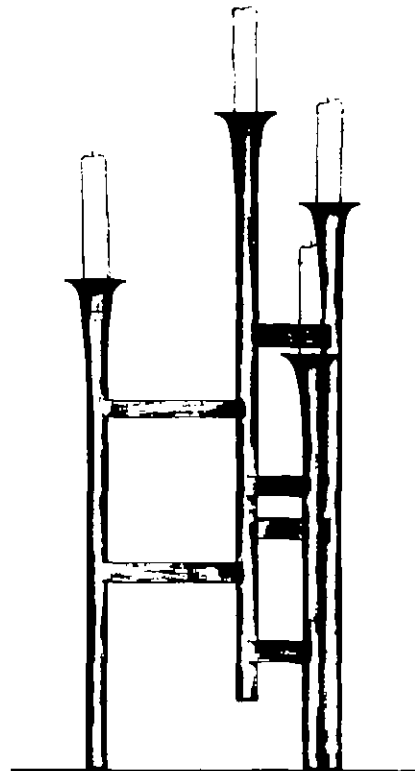

389

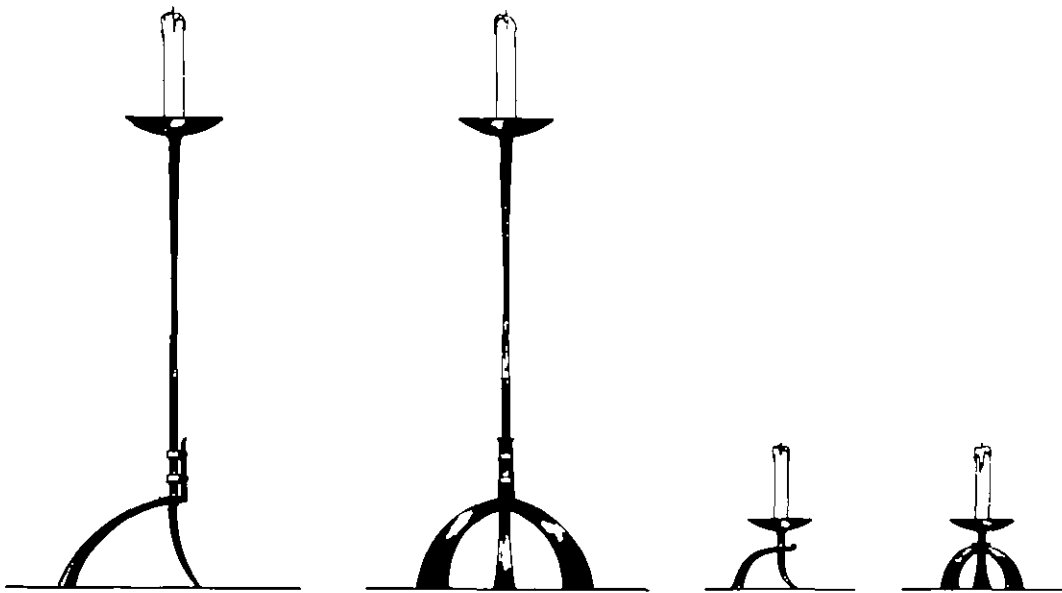

388



390

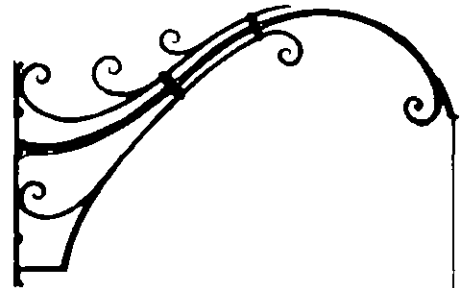
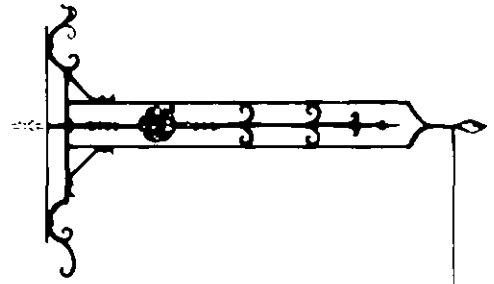
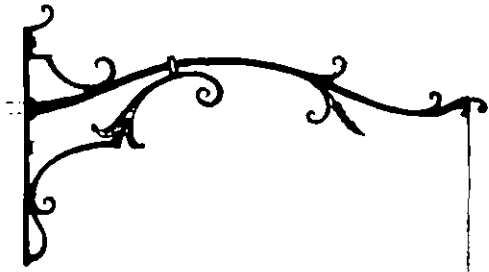



DESIGN 1



DESIGN 2

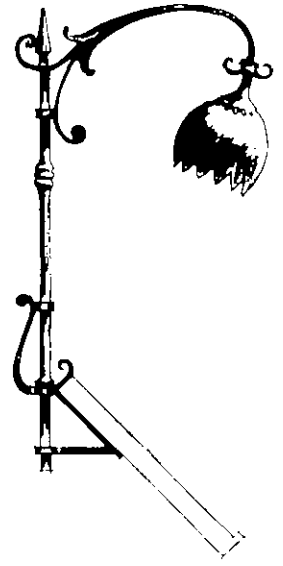

DESIGN 3

392

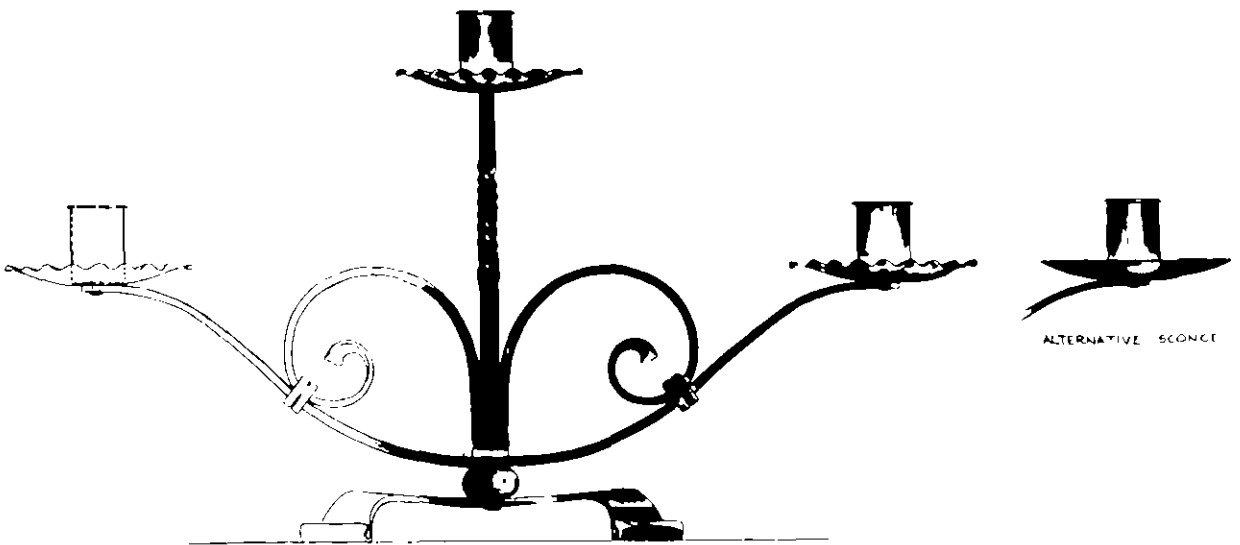

ELEVATION

ALTERNATIVE SCONCE

393

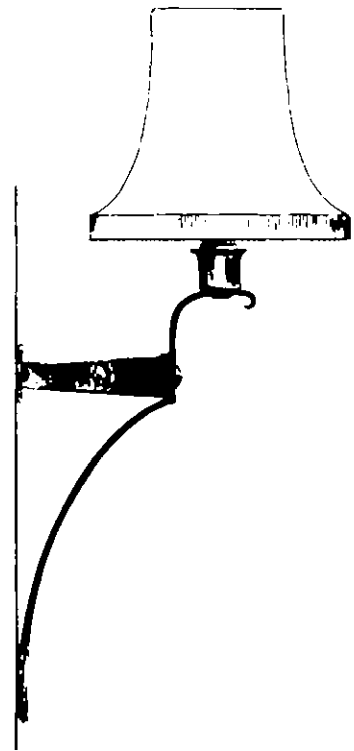
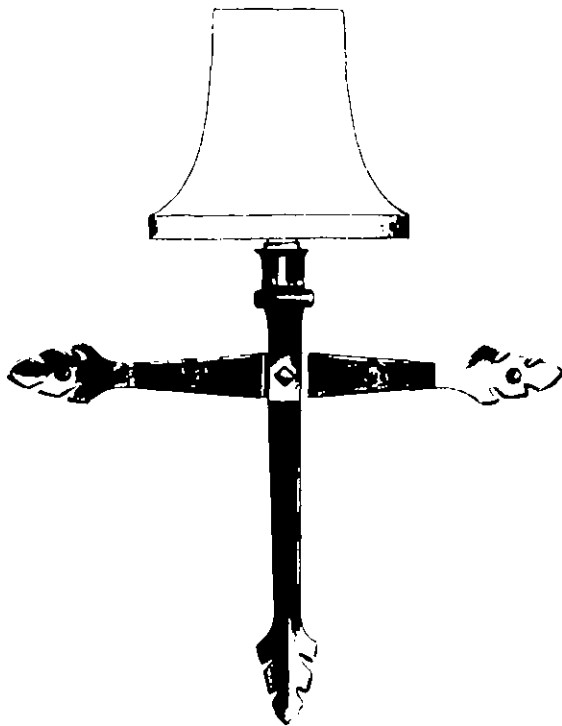

394

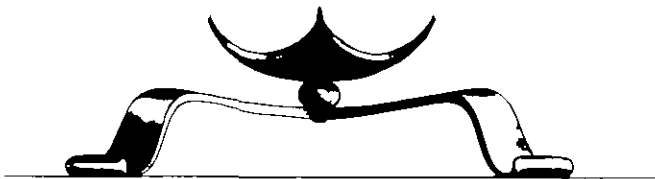

SIDE ELEVATION

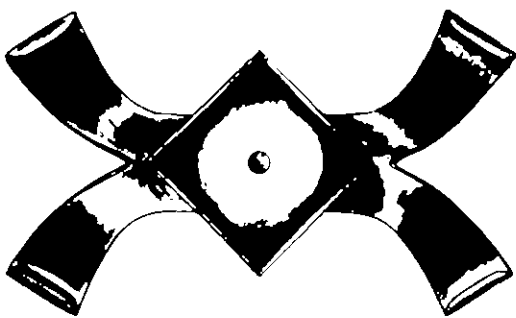

PLAN

395

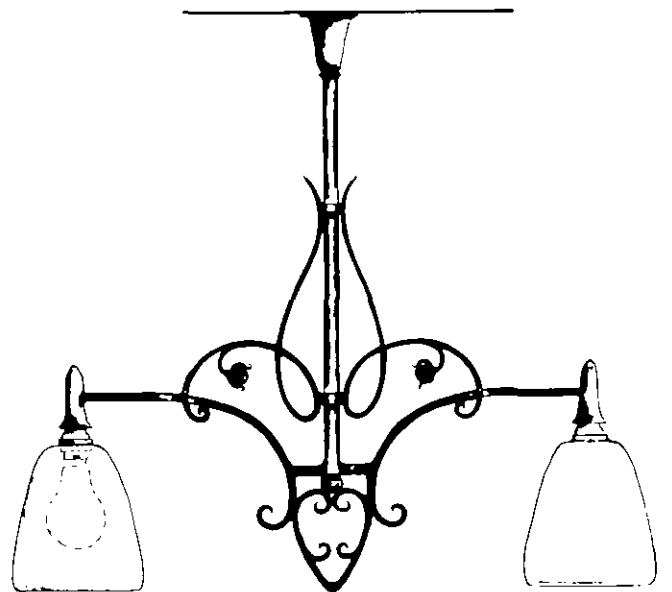

396

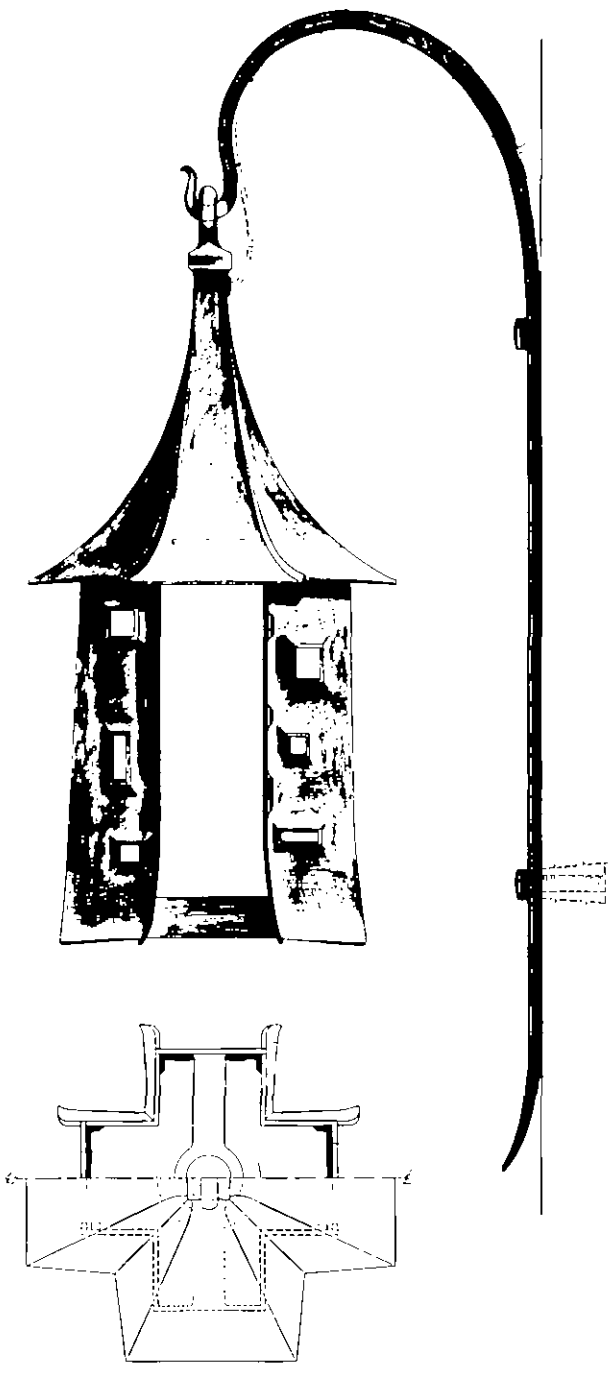

PLAN

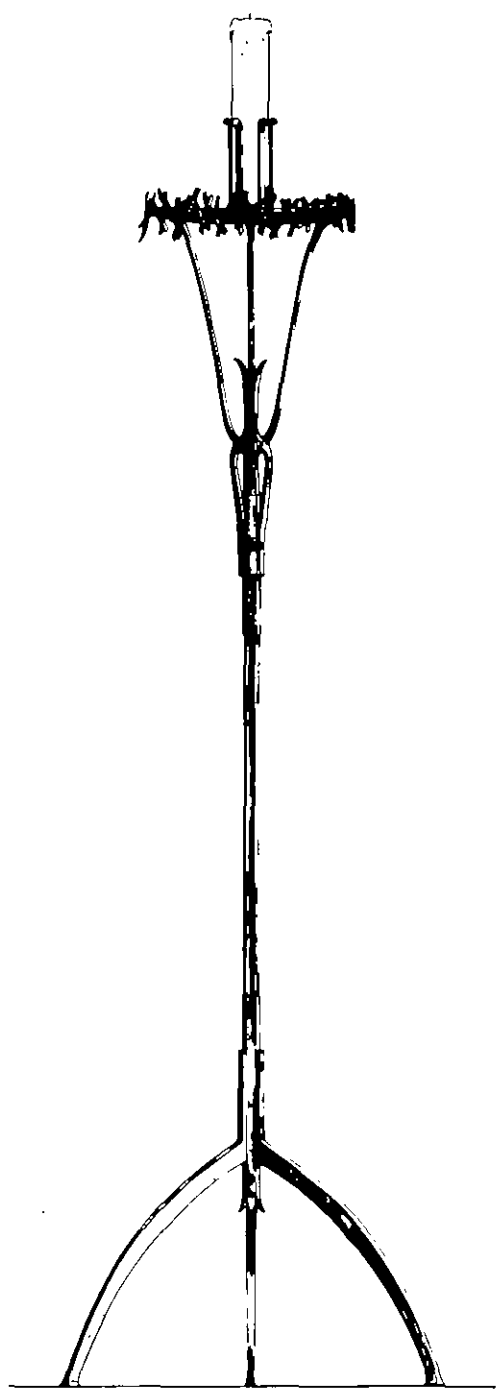

398

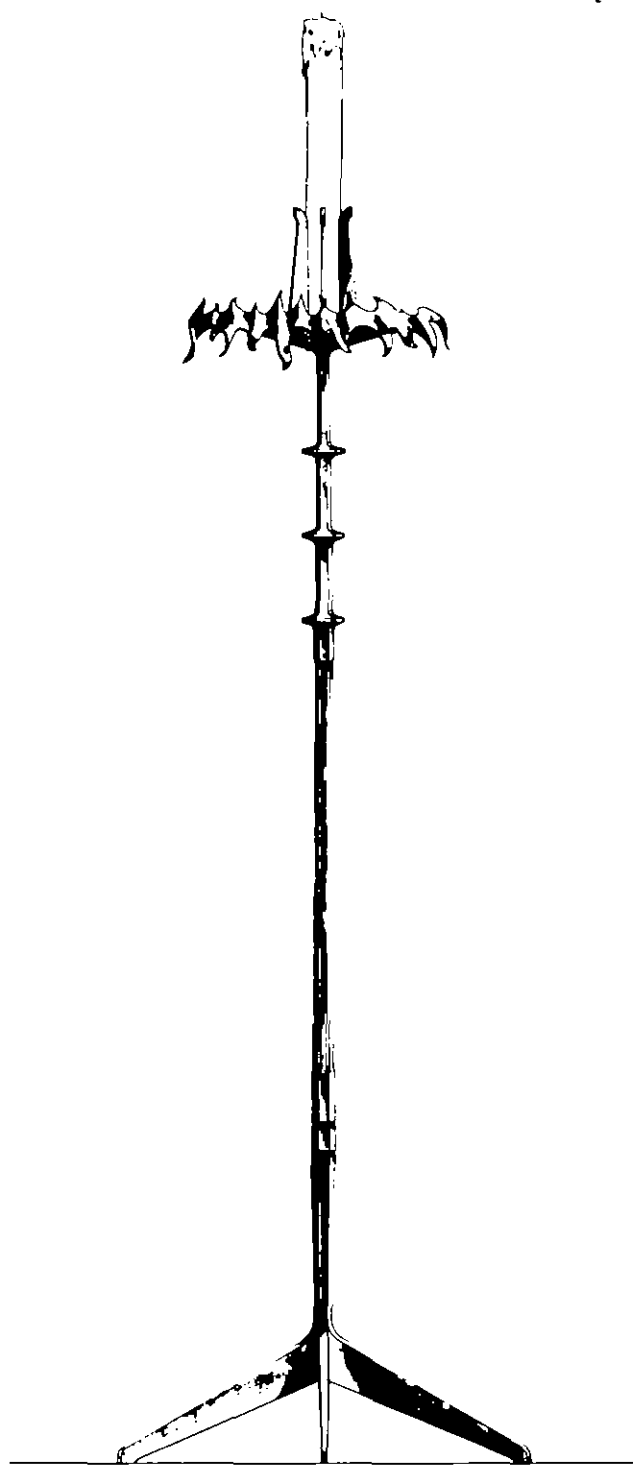

399

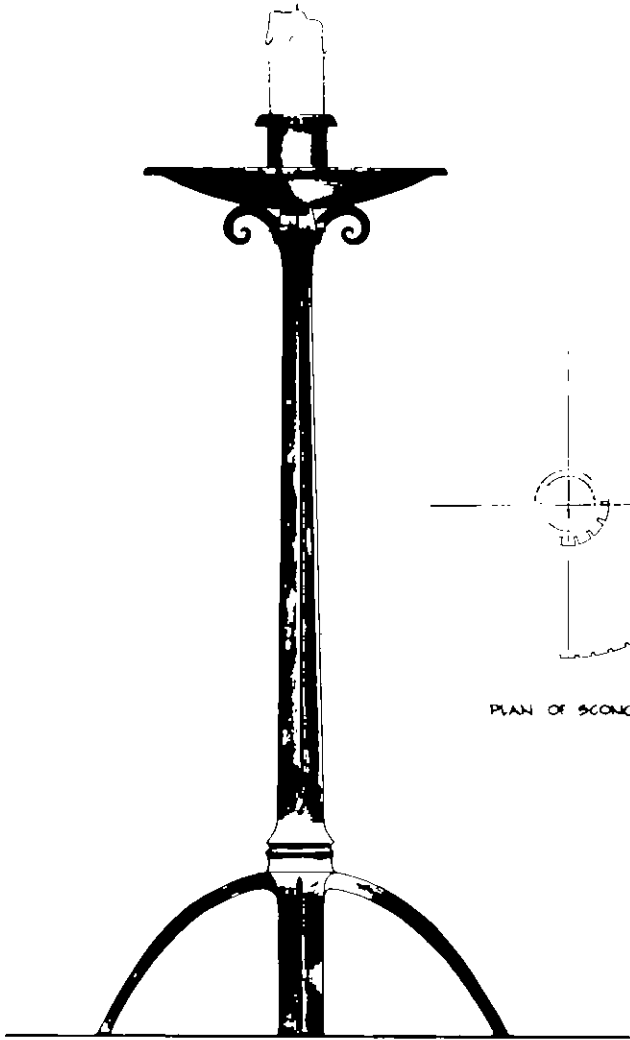

400

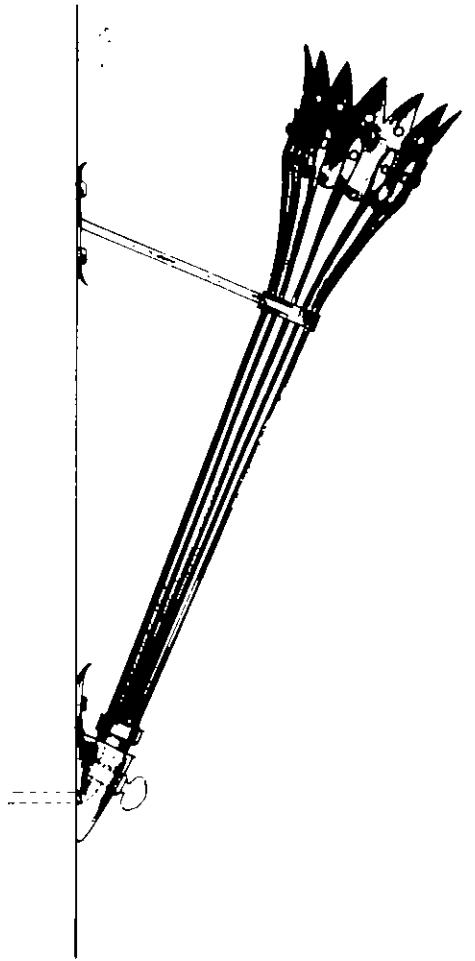

401

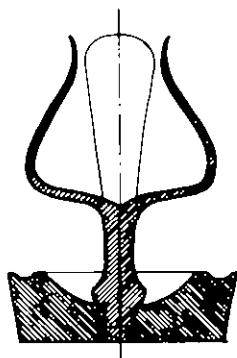

SECTION

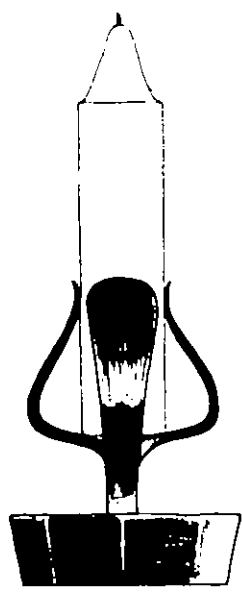

ELEVATION

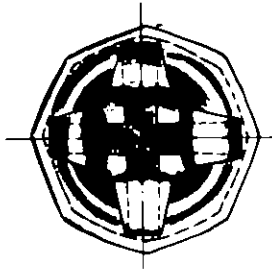

PLAN

402

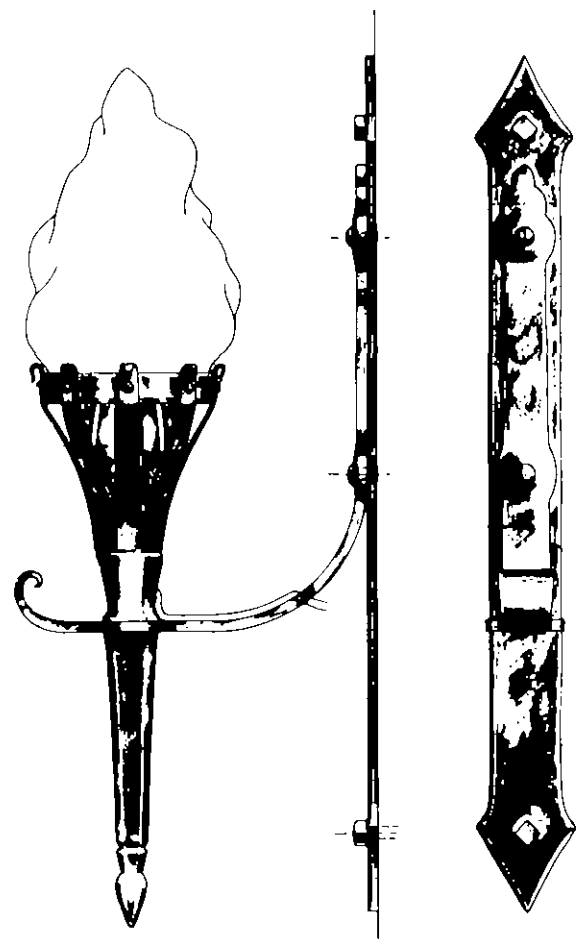

403

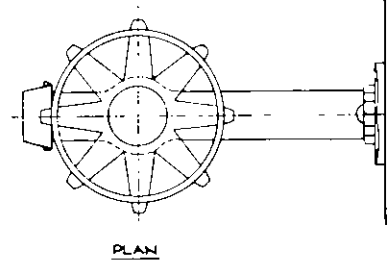

PLAN

Grilles

500	3'7" x 4'11½"
501	6'0" & 8'0" x 1'6"
502	3'0" x 8'0"
503	2'0½"
504	1'4" x 2'6"
505	3'0" x 1'6"
508	3'7" x 3'3"
507	4'7" x 2'9"
508	1'4" x 2'6"
509	2'0" x 3'0"
510	2'4½"
511	2'3"
512	3'1¾" x 3'0"
513	} 6'0" x 1'3"
514	
515	2'6"
516	2'6"
517	2'0" x 1'7"
518	2'8" x 4'0"
519	5'7" x 2'2"
520	2'8" x 4'0"
521	3'0" x 2'0"
522	2'0" x 3'0½"
523	4'0" x 2'3"
524	4'0" x 2'3"
525	3'3" x 1'5"
526	2'4" x 1'7"
527	6'0", 8'0", & 10'0" x proportionate width
528	3'5" x 2'8"
529	7'6" x 5'0"
530	7'6" x 5'0"
531	2'4" x 1'7"
532	2'9" x 2'6"
533	3'9" x 2'10½"
534	3' x 3'2"
535	2'4" x 1'3"
536	2'9" x 2'4"
537	4'6" x 3'0"
538	2'4½"

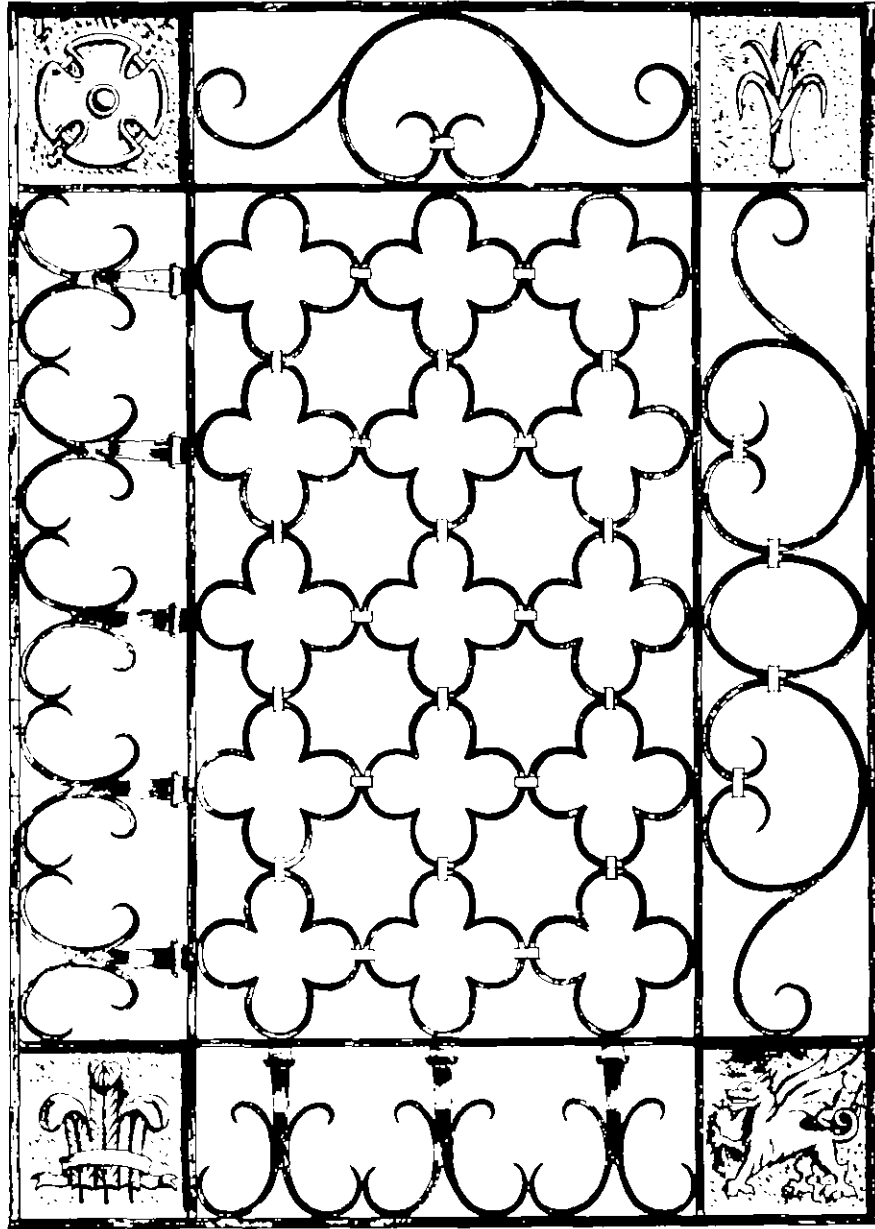

500

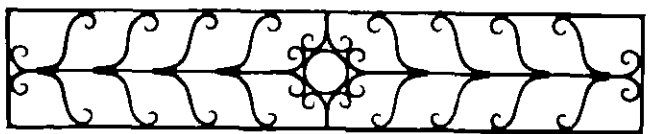
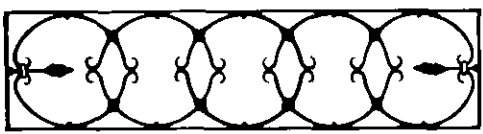

501

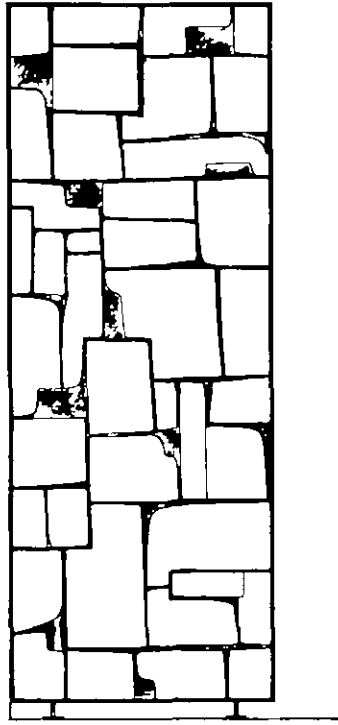

502

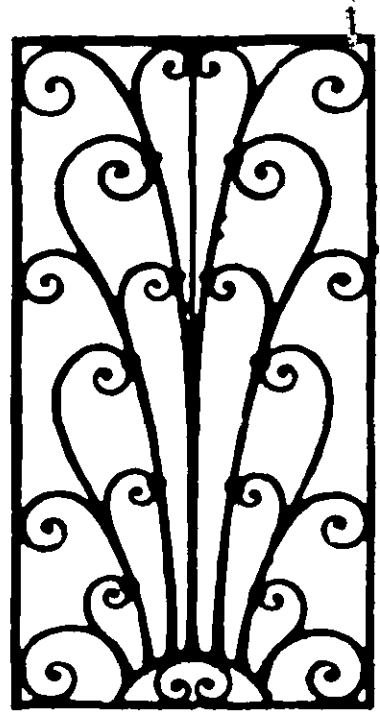

504

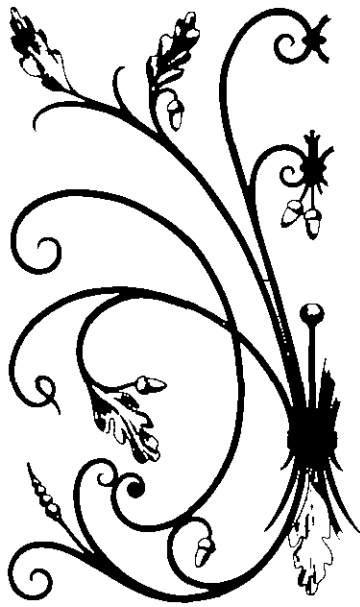

503

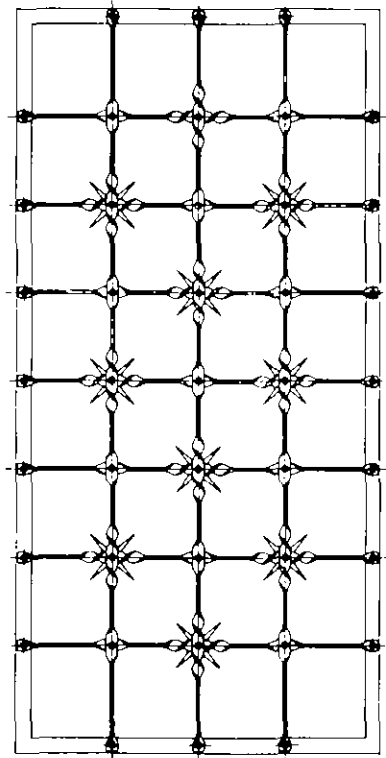

505

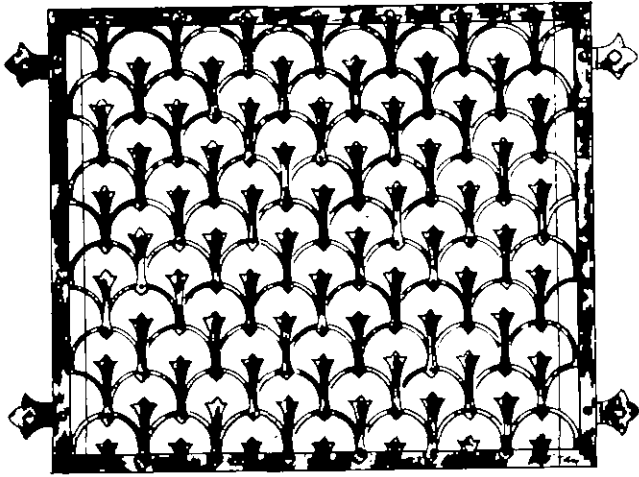

506

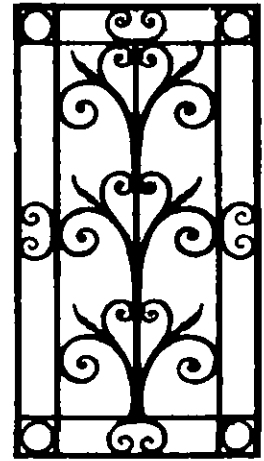

508

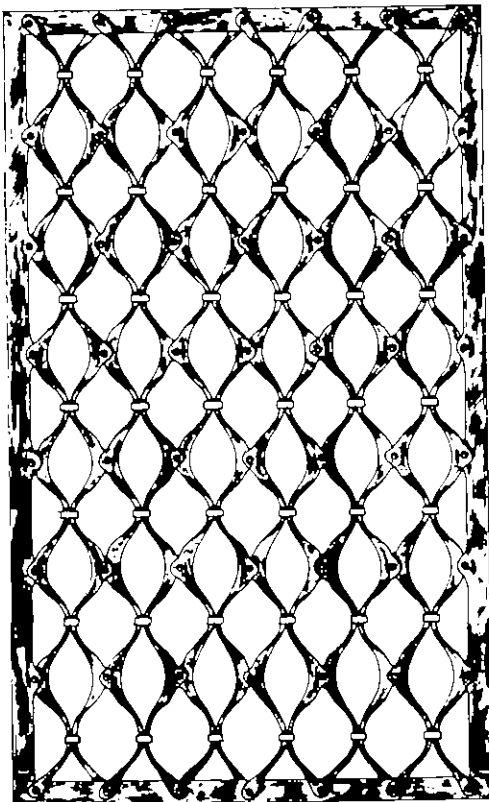

507

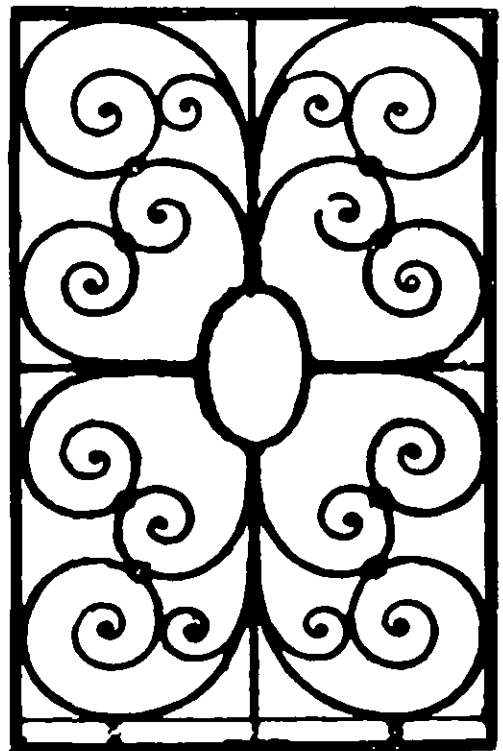

509

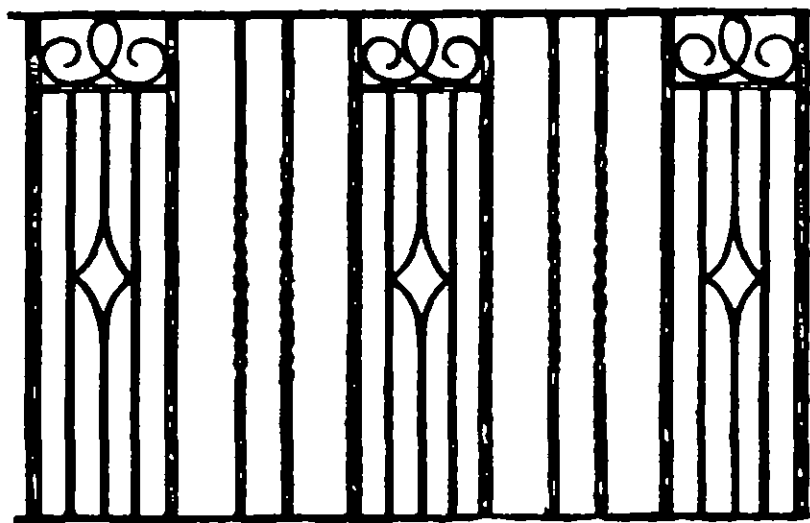

510

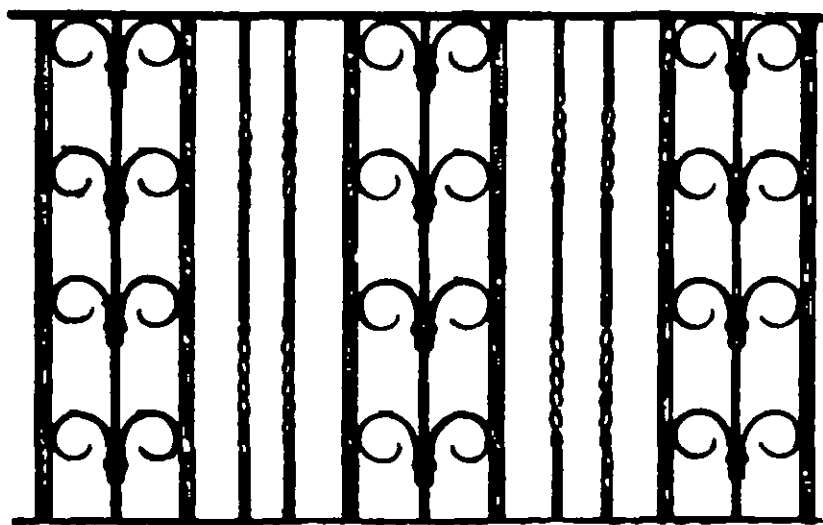

511

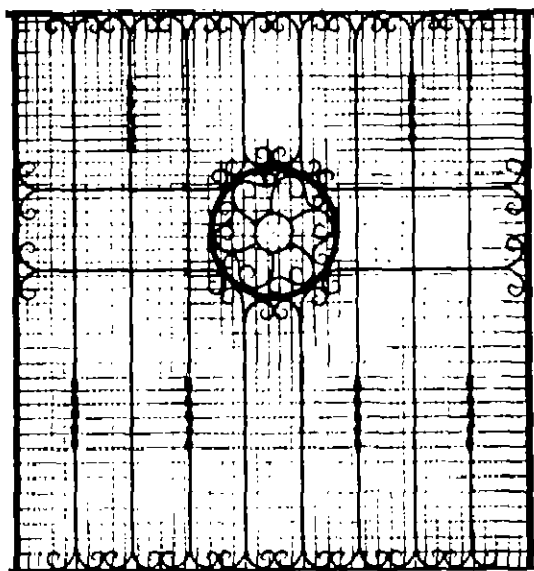

512

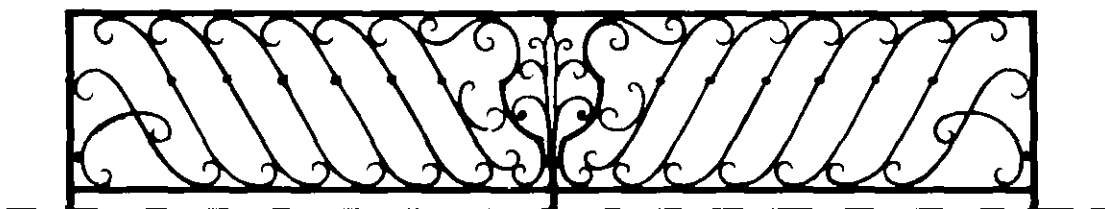

513

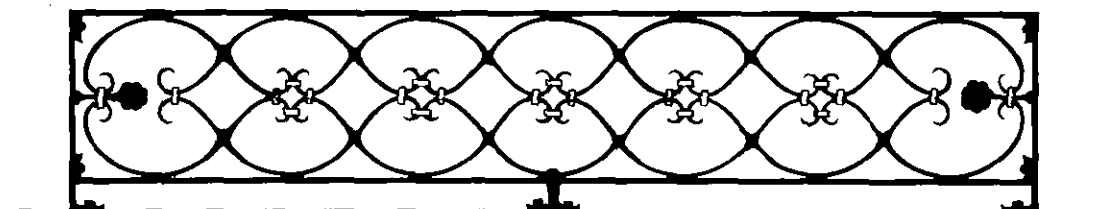

514

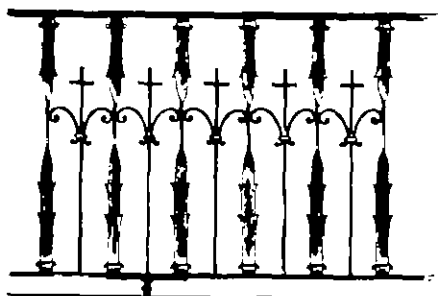

515

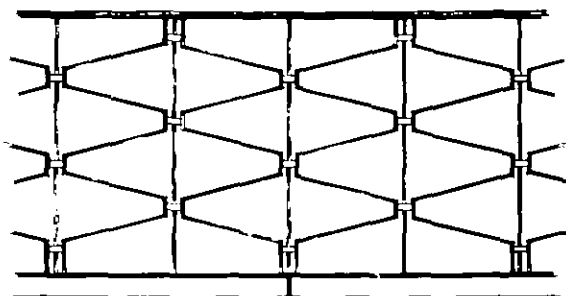

516

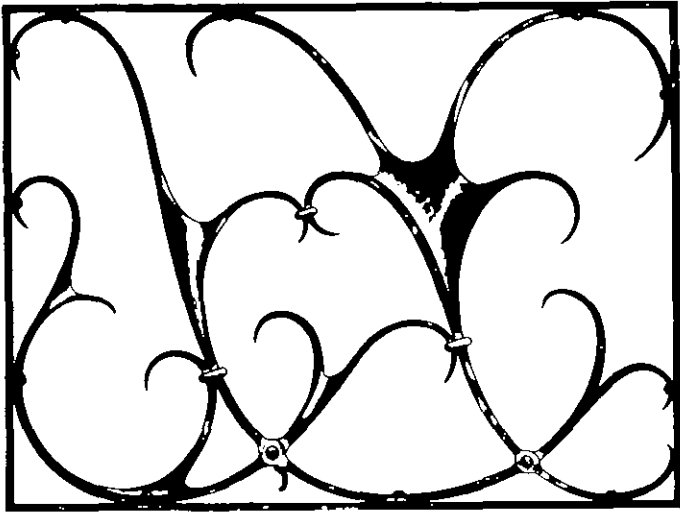

517

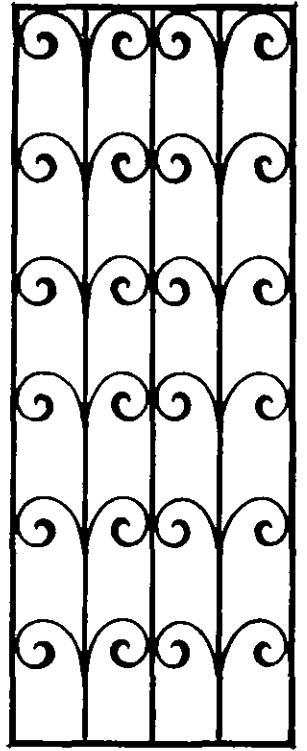

519

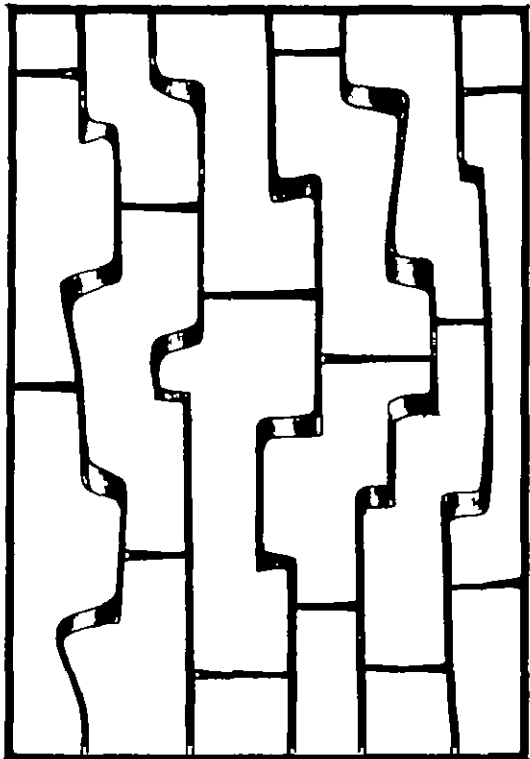

518

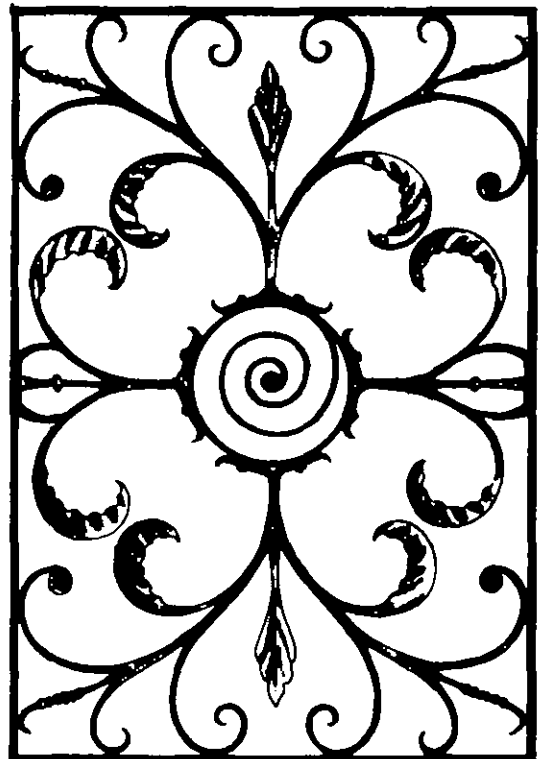

520

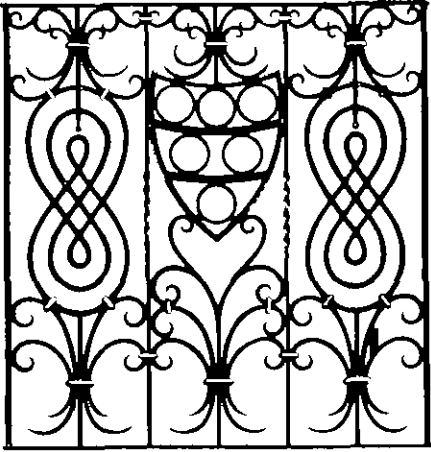

521

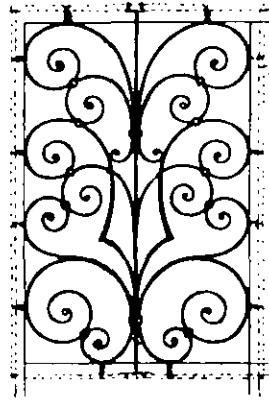

522

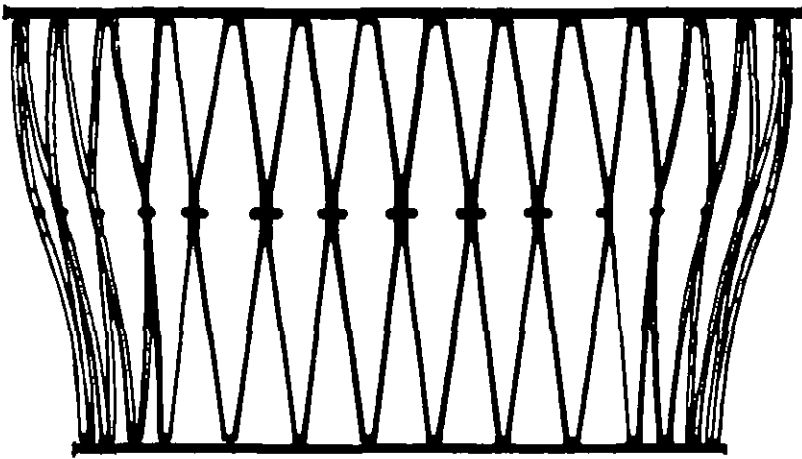

523

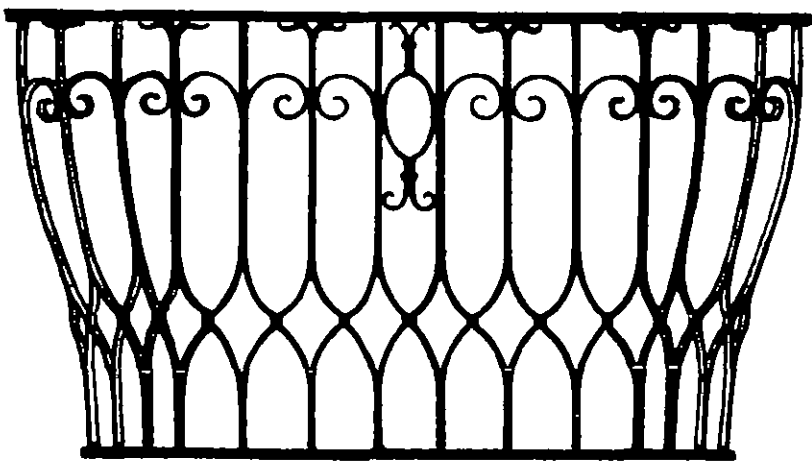
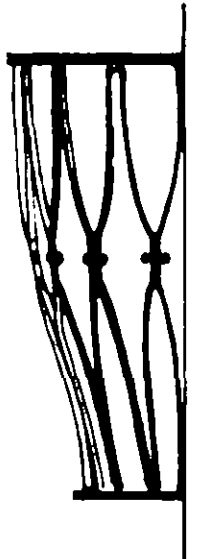

524



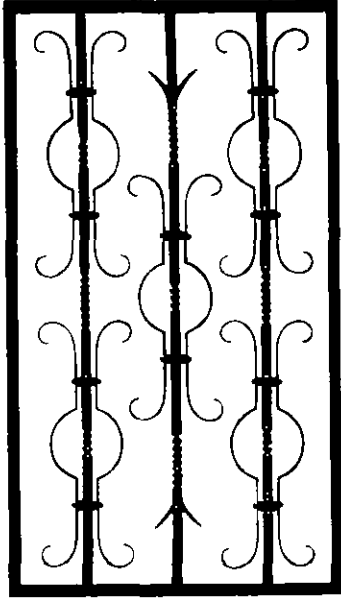

525

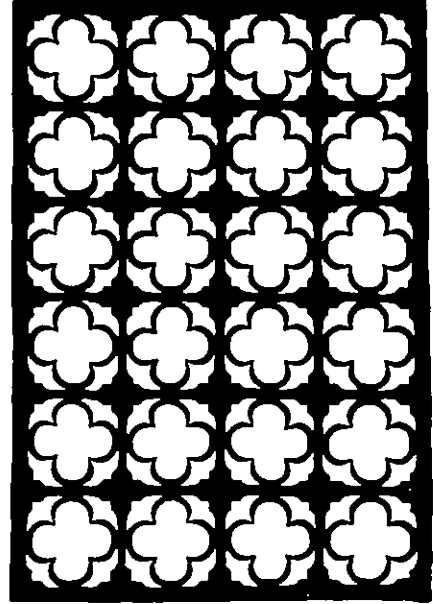

526

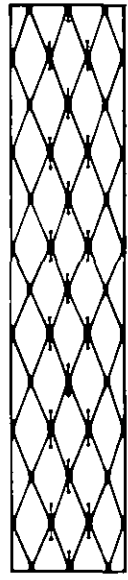
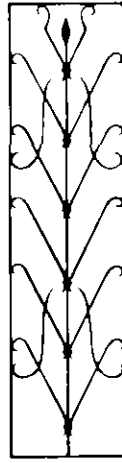
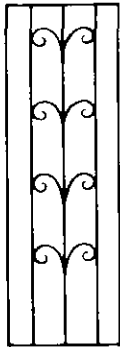
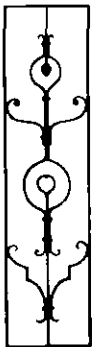

527

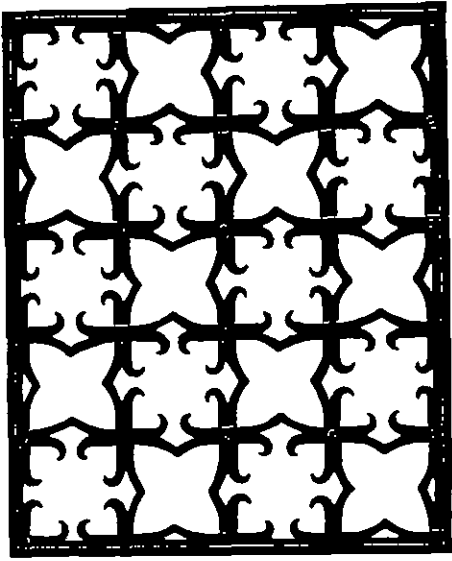

528

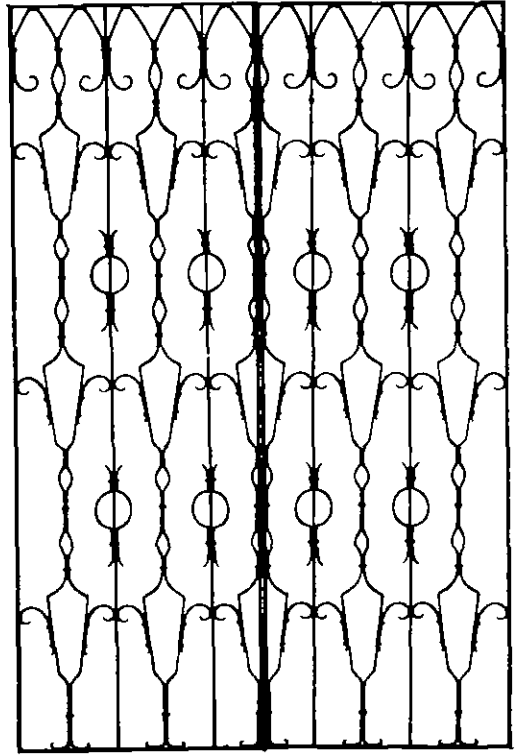

530

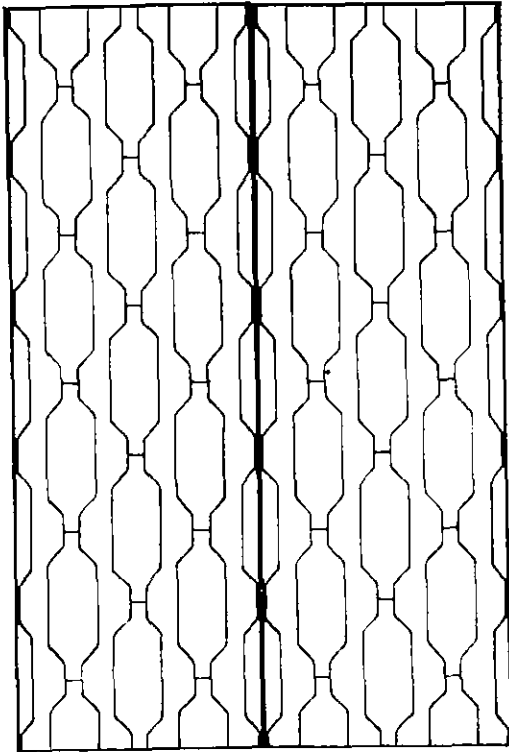

529

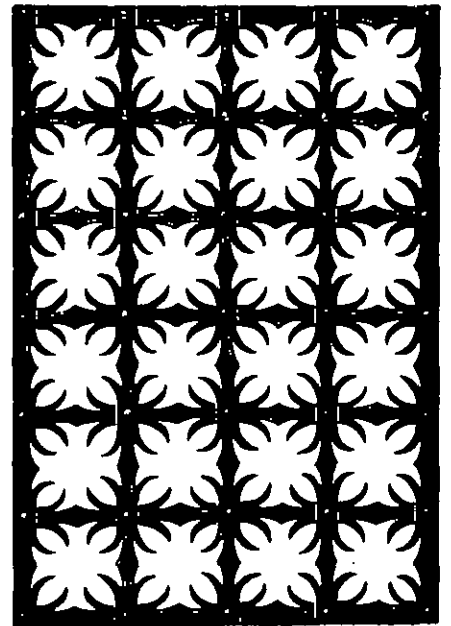

531

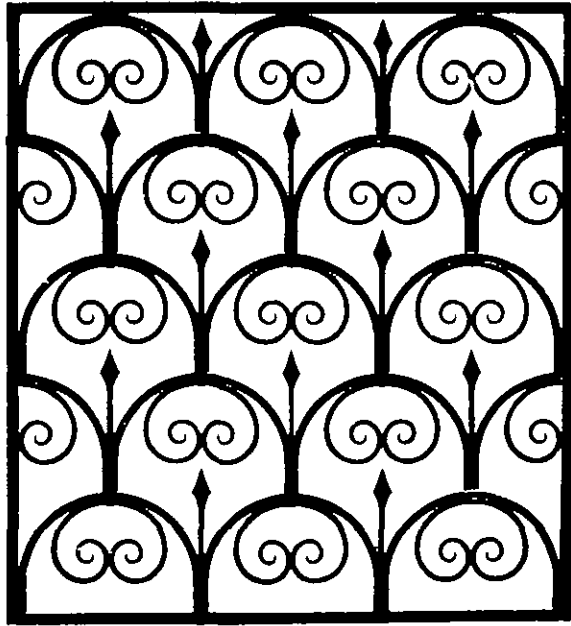

532

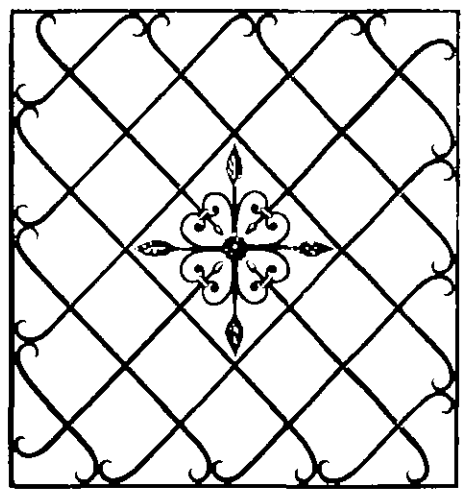

534

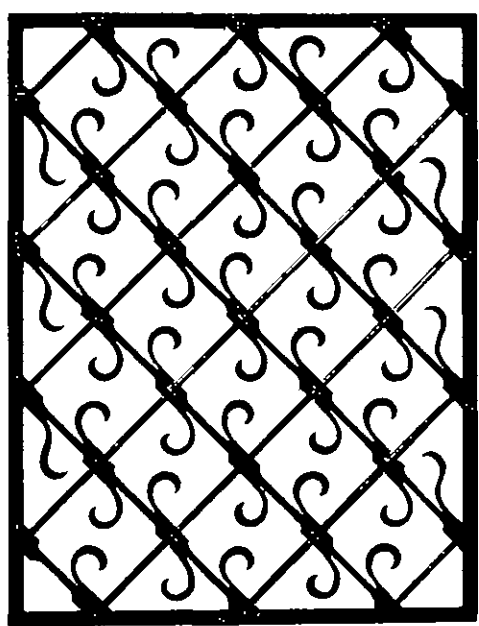

533

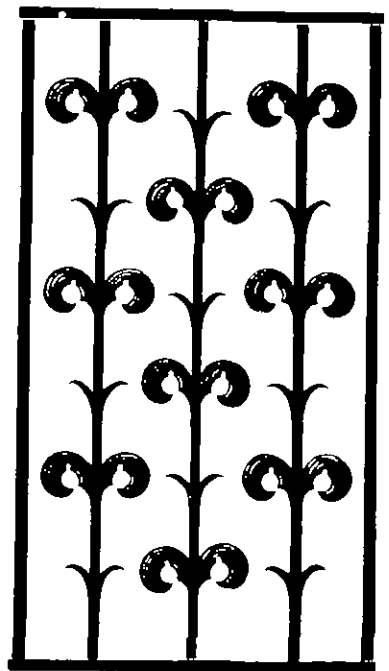

535

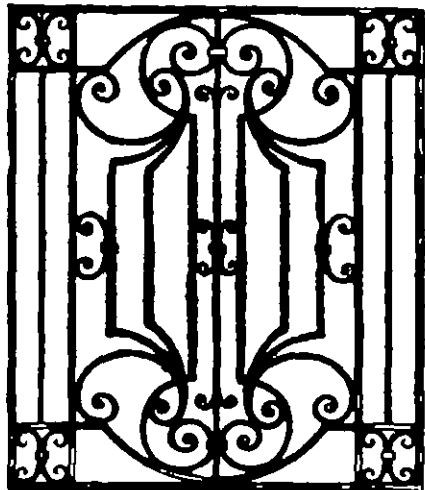

536

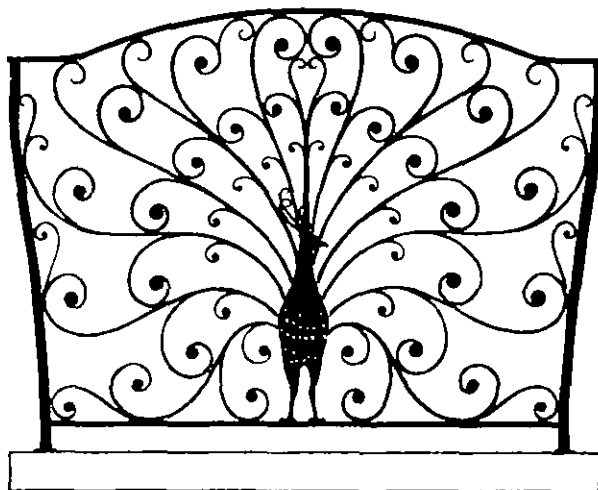

537

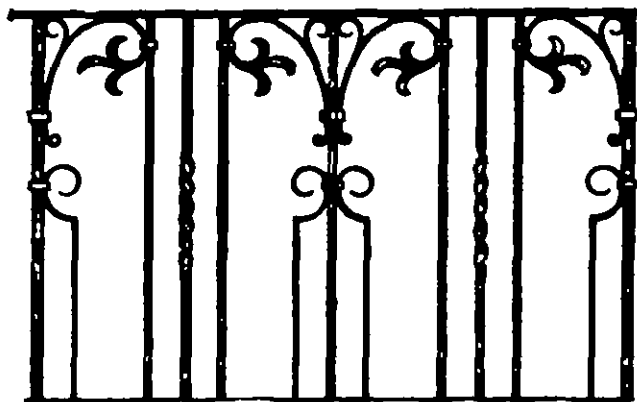

538

Plant Stands and Brackets

630	4'6"
631	4'6"
632	4'6"
633	4'5½"
634	4'7"
635	3'0"
636	5'0"
637	3'0" × 1'9"
638	5'0"
639	1'0"
640	1'9"
641	1'9" × 1'6"
642	1'6"
643	3'10" × 1'9"
644	2'1"

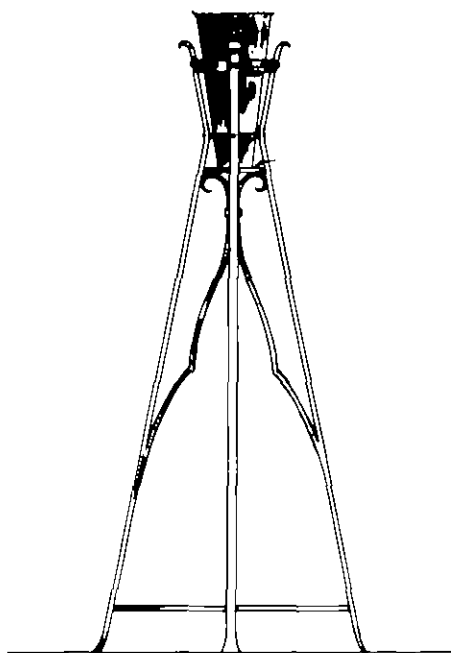

630

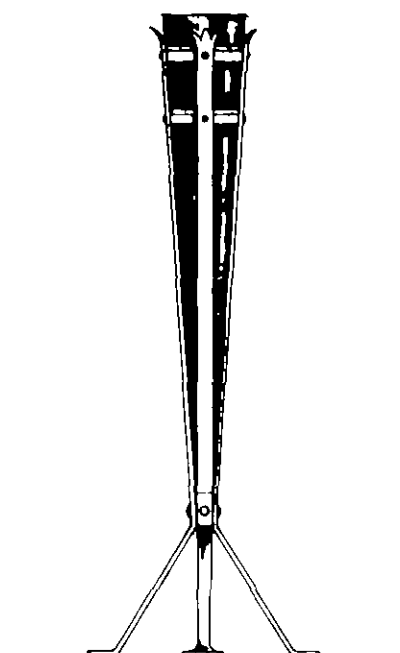

632

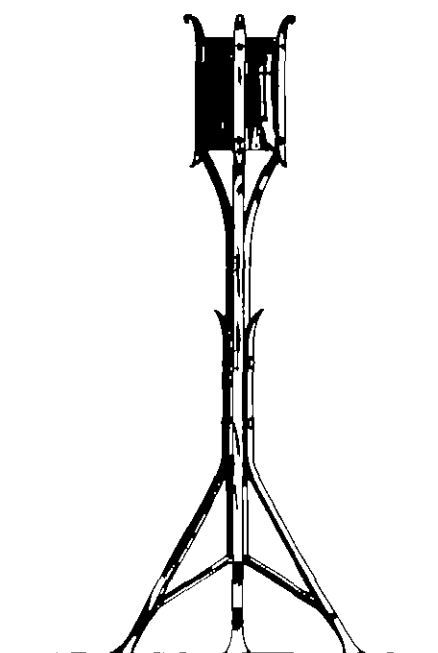

631

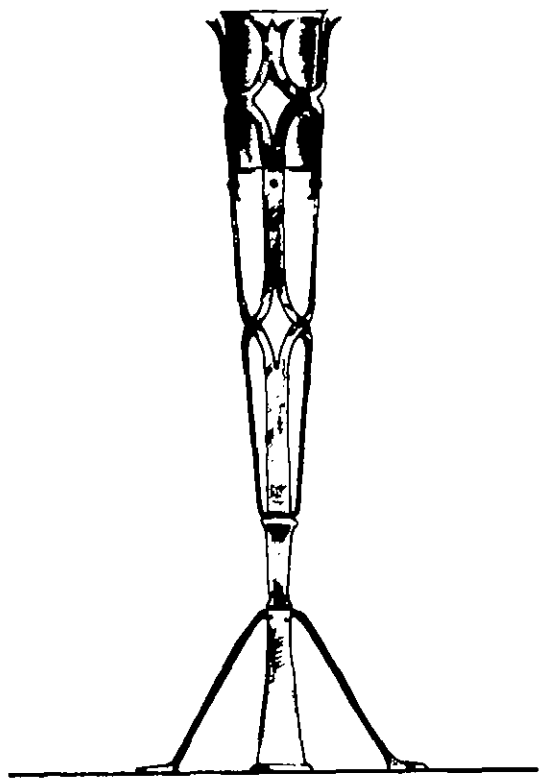

633

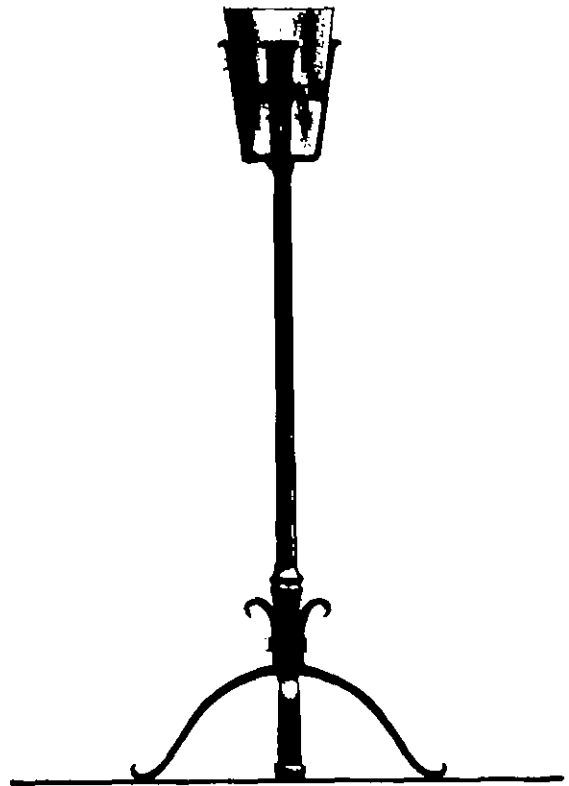

634

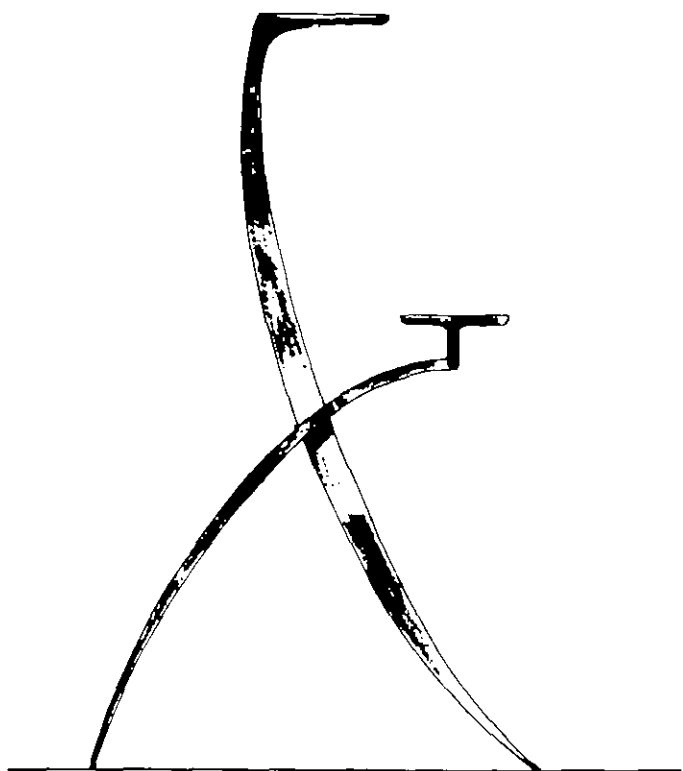
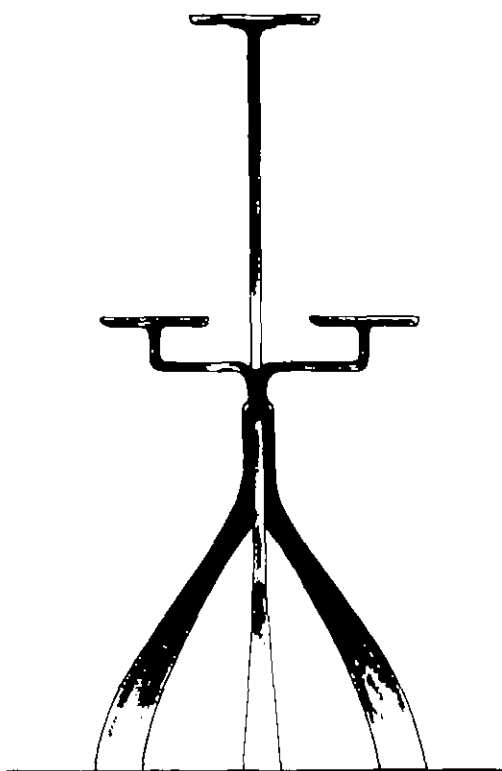

635

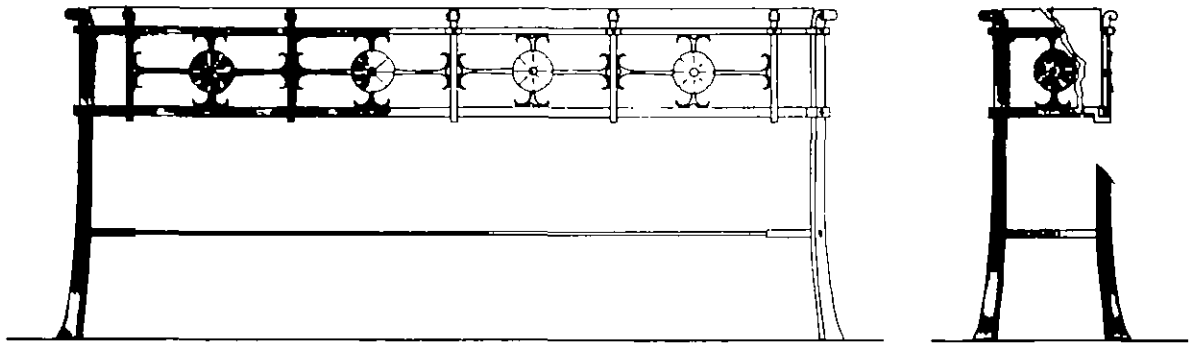

636

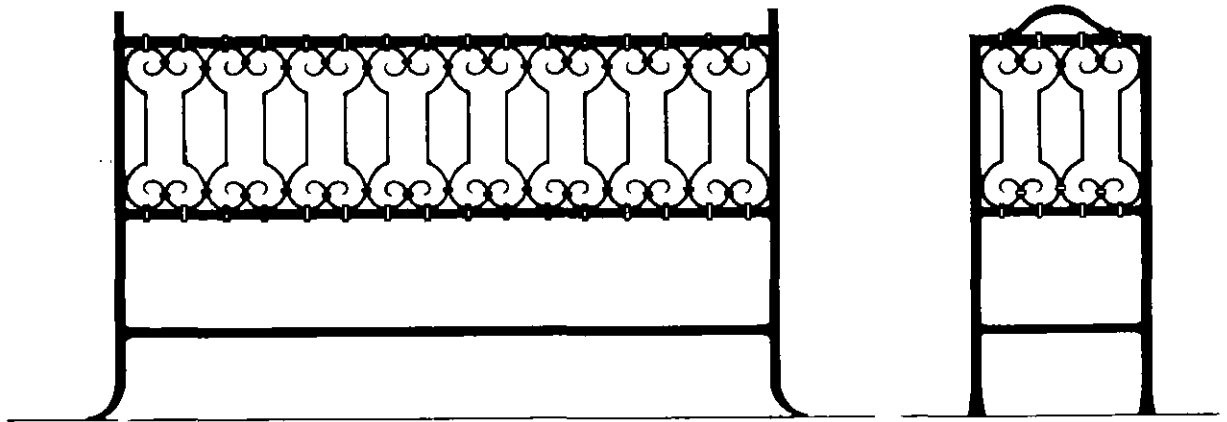

637

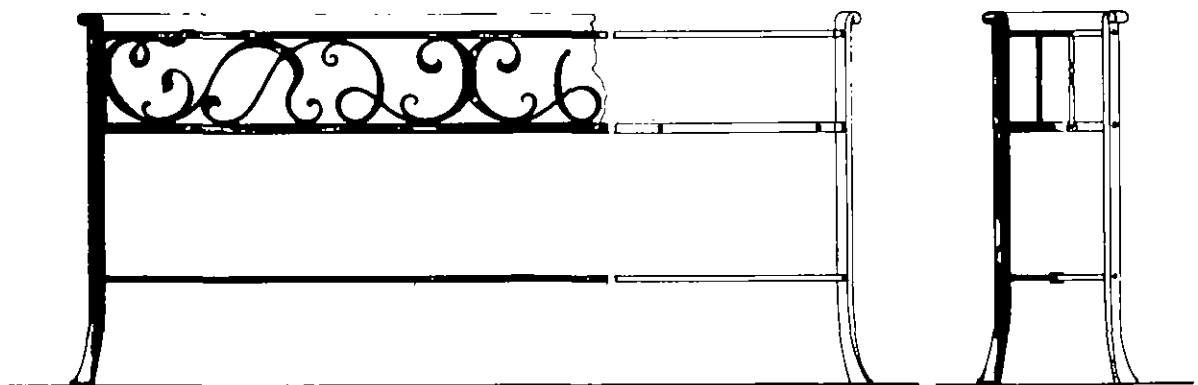

638

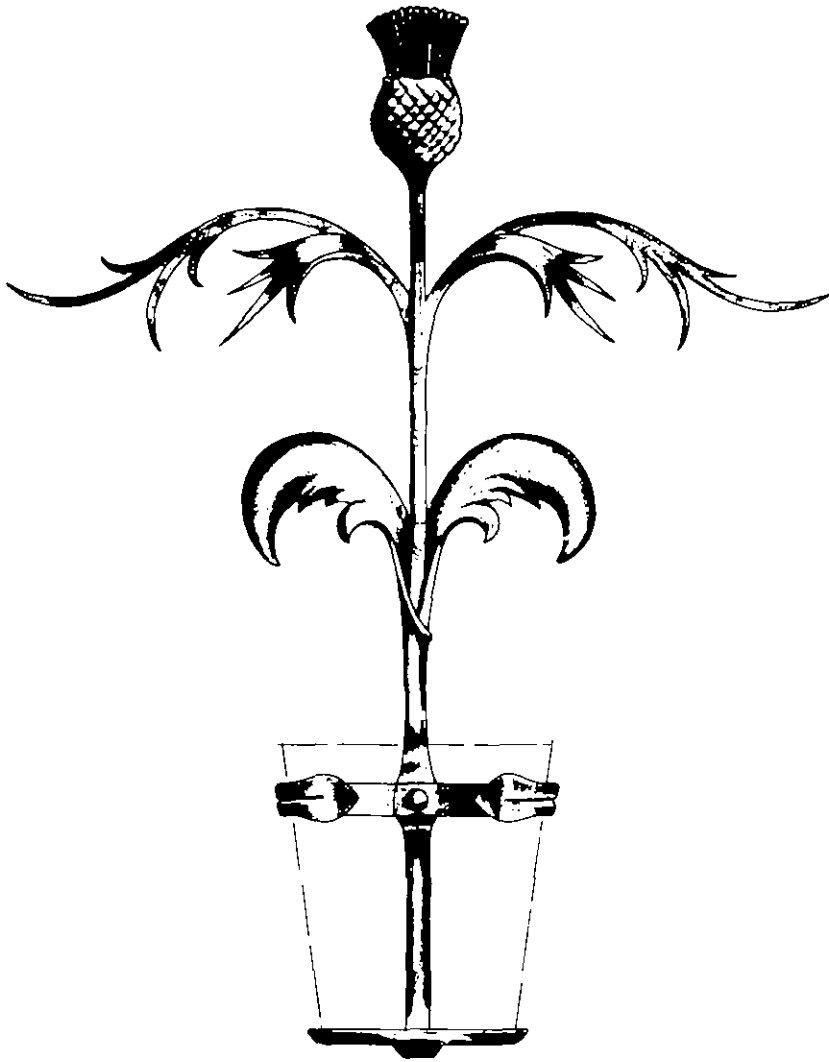

639

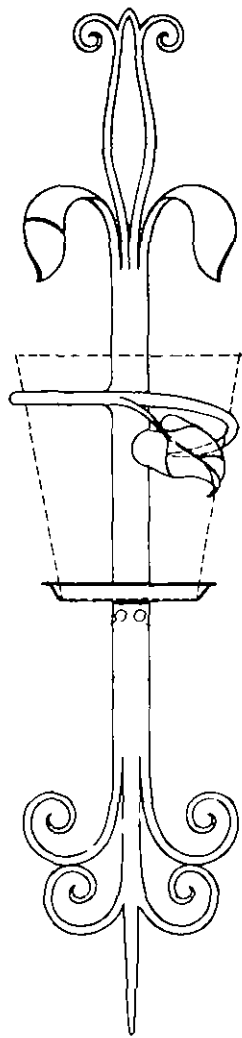

640

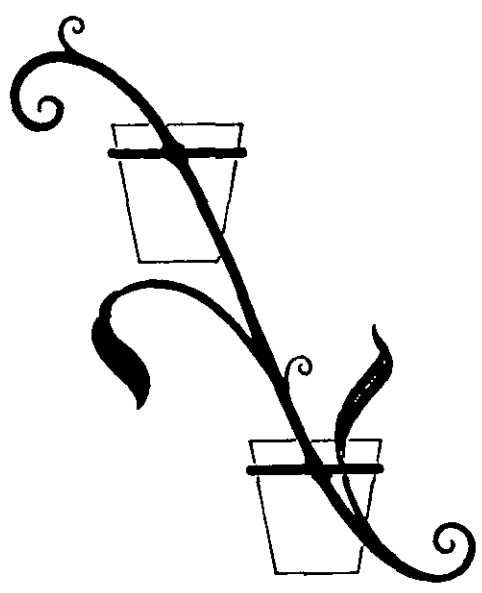

642

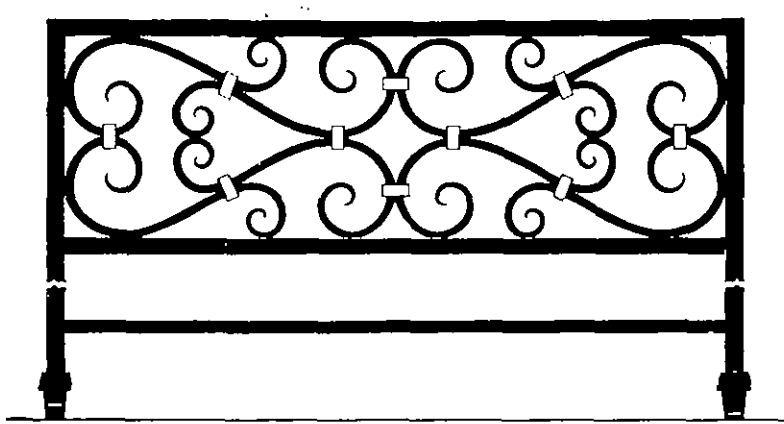

641

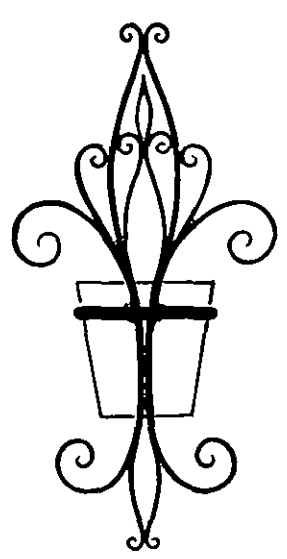

643

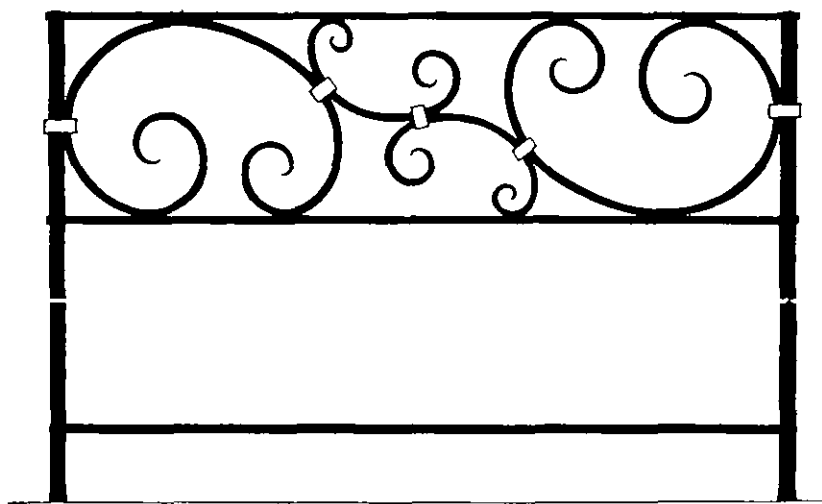

644

Sign Stands and Brackets

750	3'4" x 1'6"
751	5'0"
752	5'0"
753	3'9" x 1'7"
754	3'4" x 1'8"
755	3'4" x 1'8"
756	10'8"
757	11'0"
758	10'4"
759	10'0"
760	10'4"
761	10'8"
762	9½" dia.
763	4'6" x 2'11"
764	6'0" x 3'1"
765	3'0" x 3'3"
766	5'4" x 5'0"
767	3'7½" x 3'1"
768	2'10½" x 3'3"
769	4'0" x 3'3"
770	3'6" x 3'0"
771	4'0" x 3'6"
772	2'4" x 2'1" or 2'10" x 2'1"
773	12" x 9"
774	12" x 9"
775	1'8" x 1'2"
776	2'2" x 1'6"

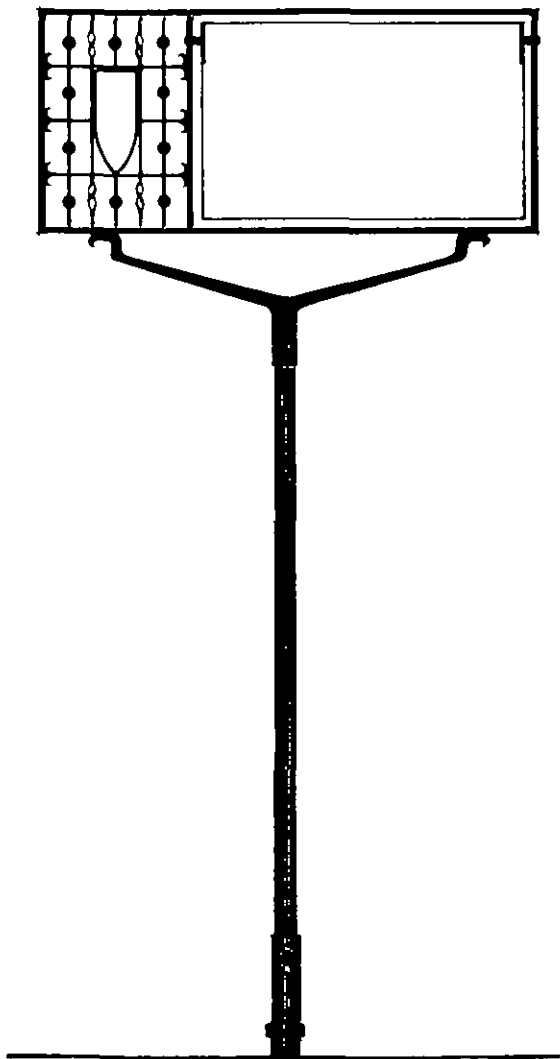

750

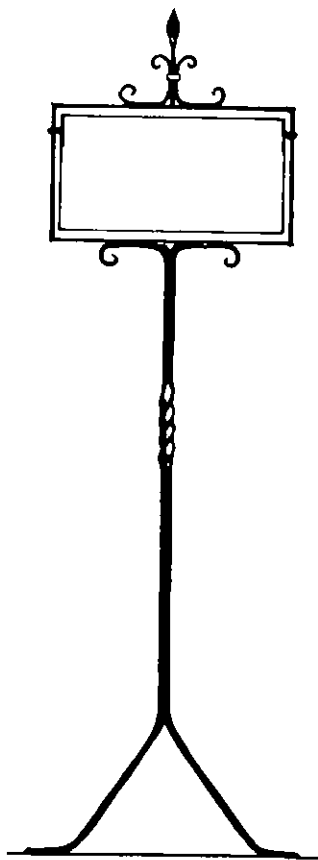

751

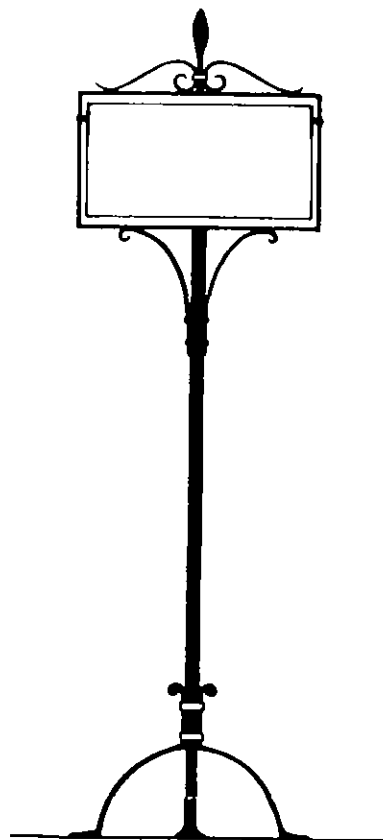

752

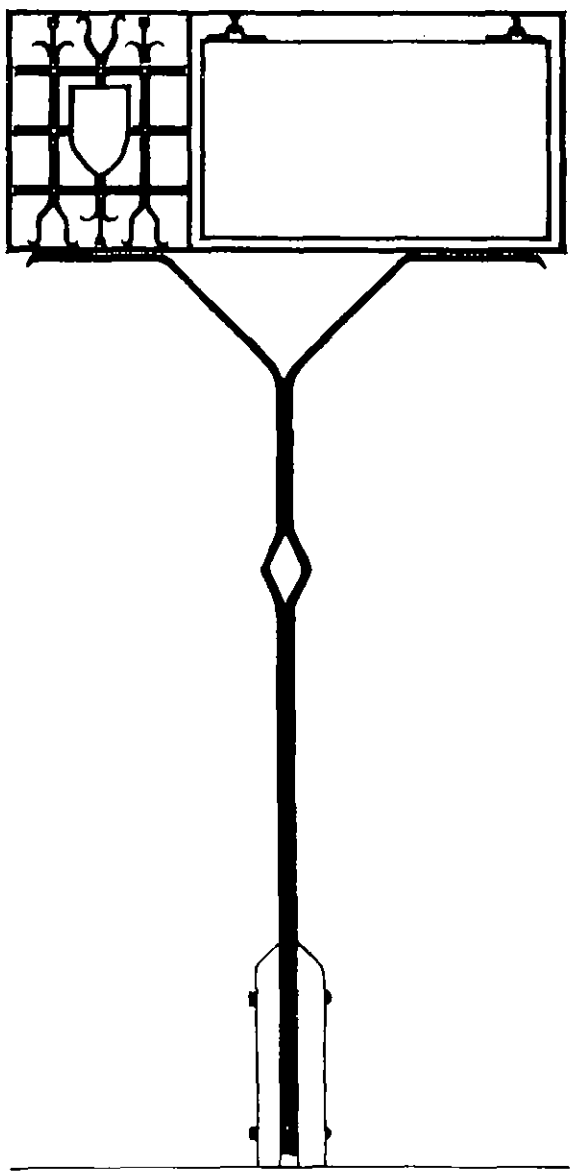

753

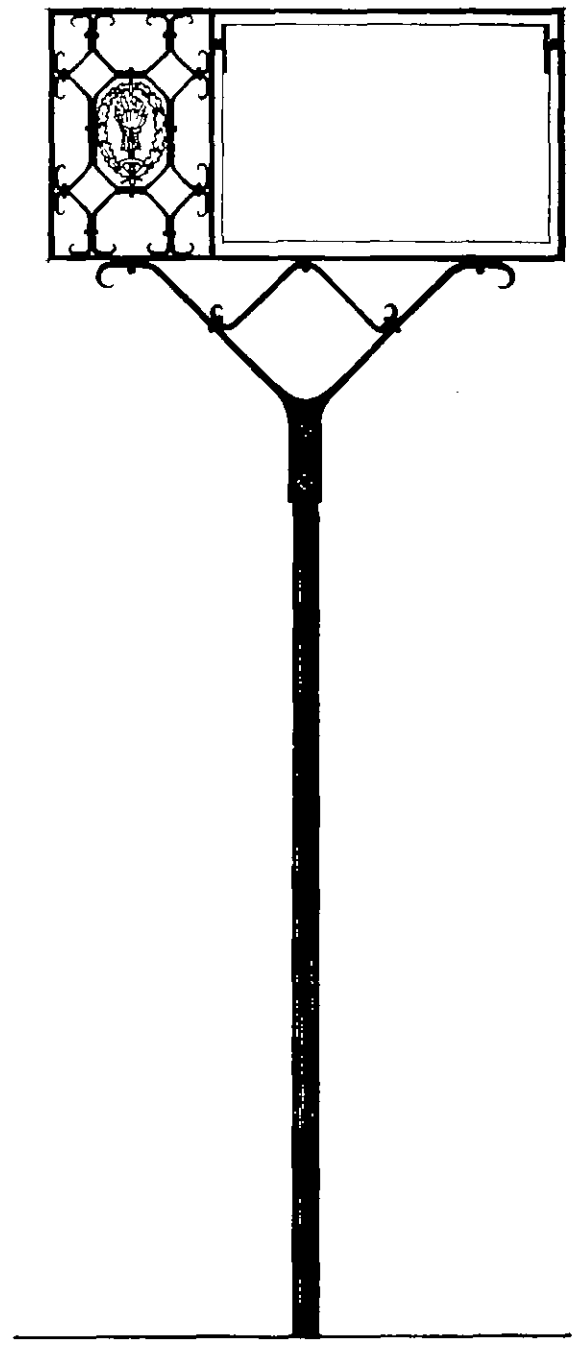

754

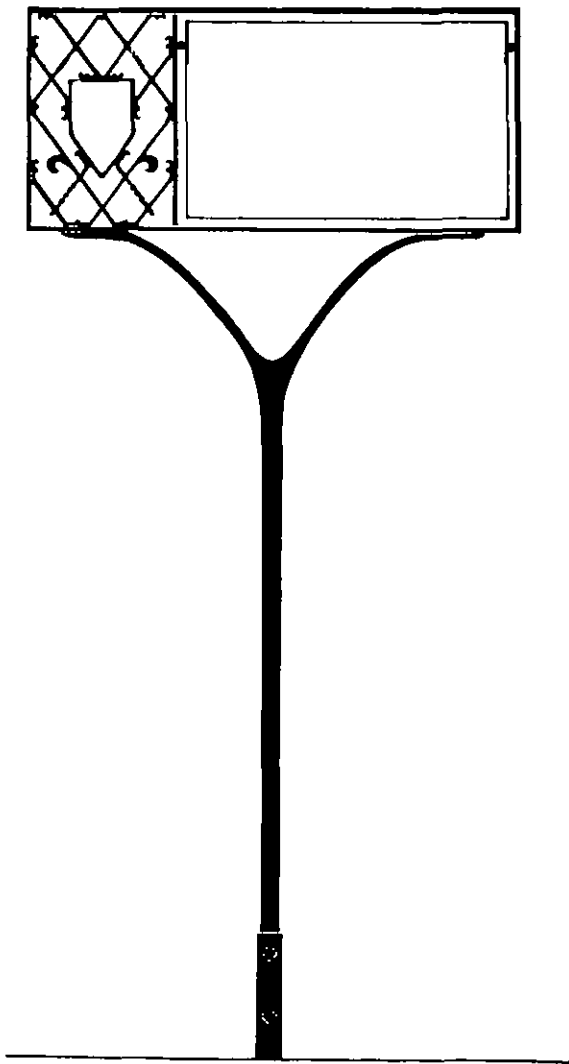

755

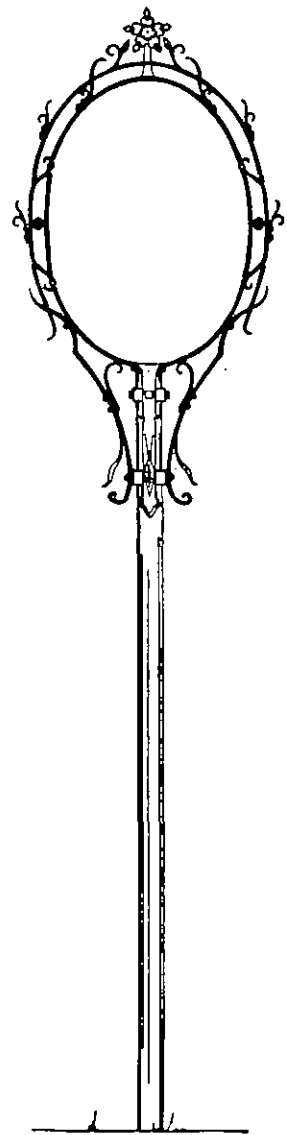

756

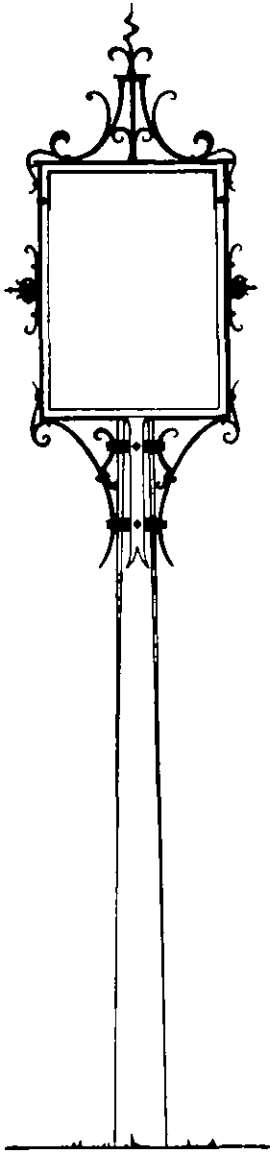

757

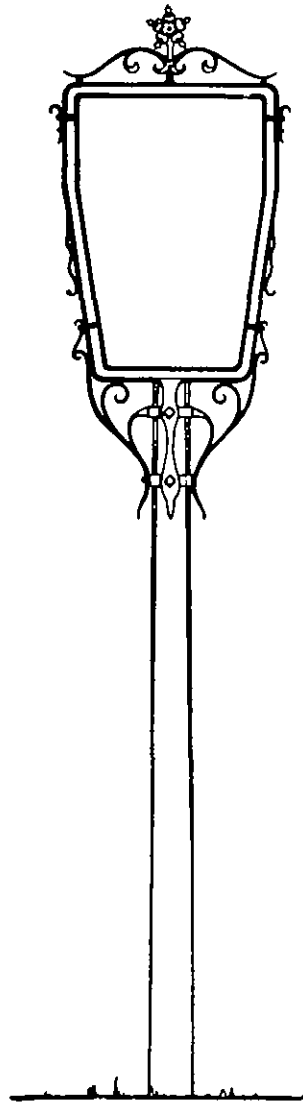

758

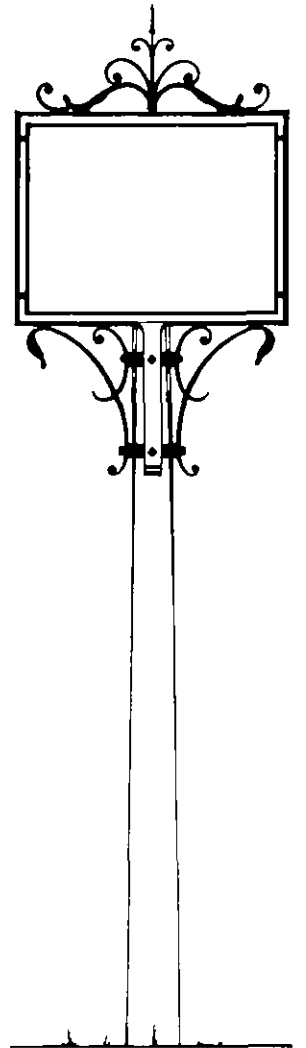

759

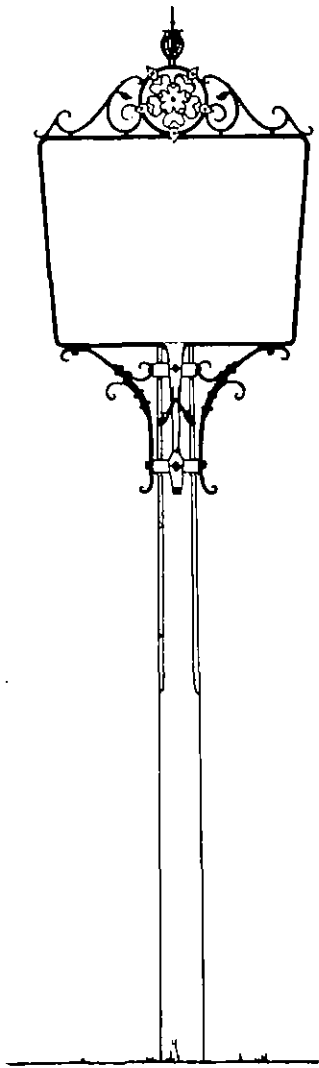

760

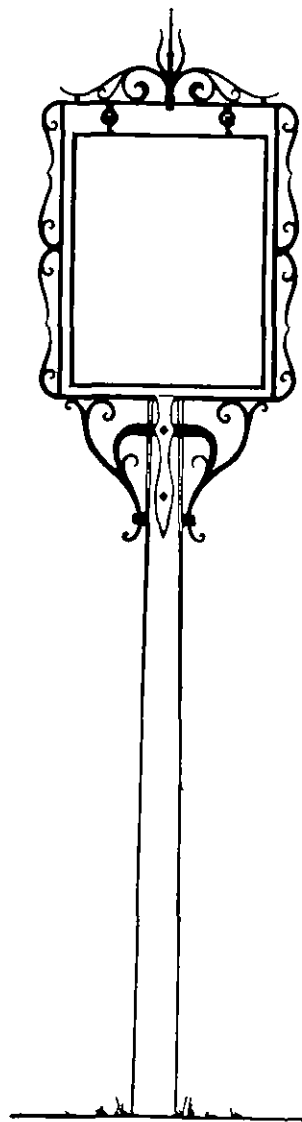

761

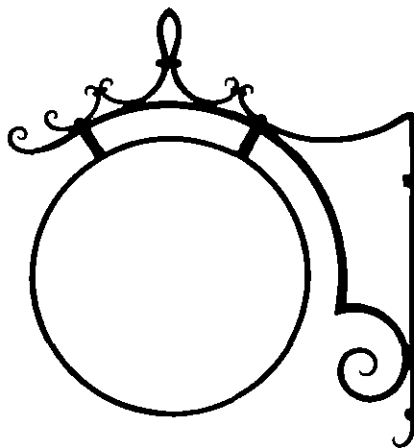

762

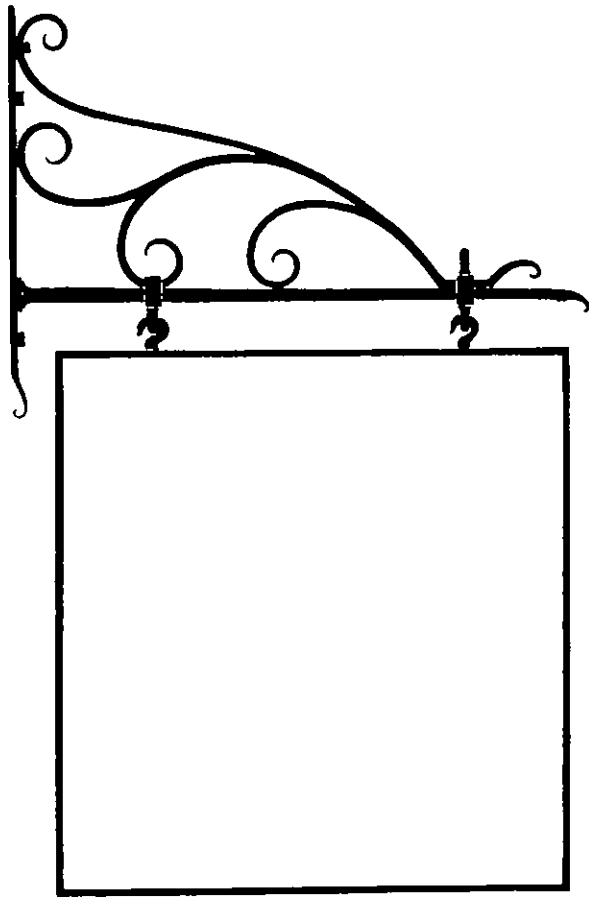

763

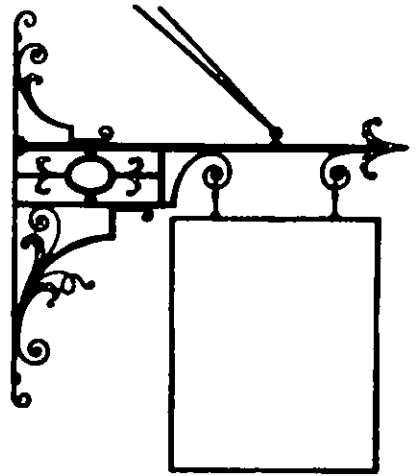

765

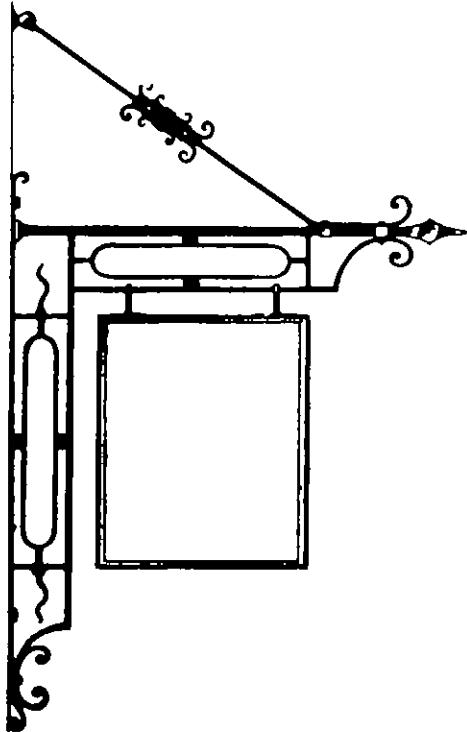

764

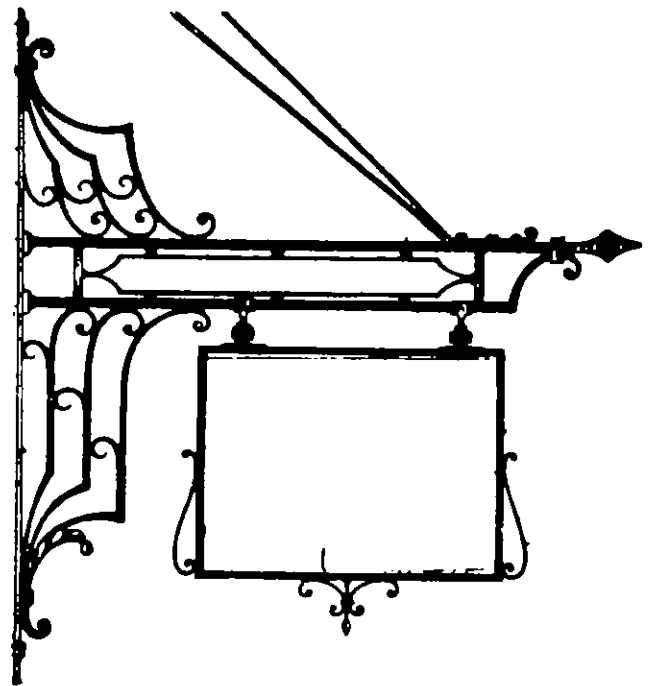

766

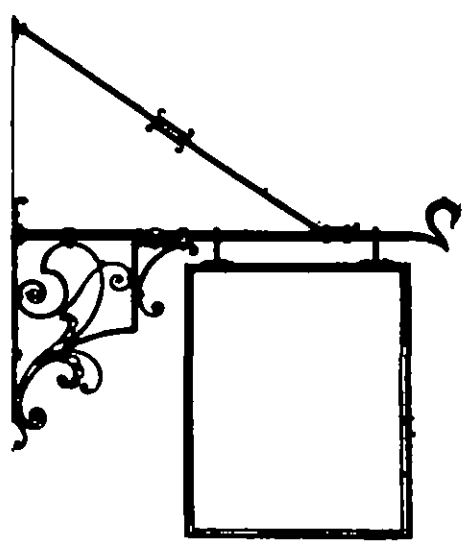

767

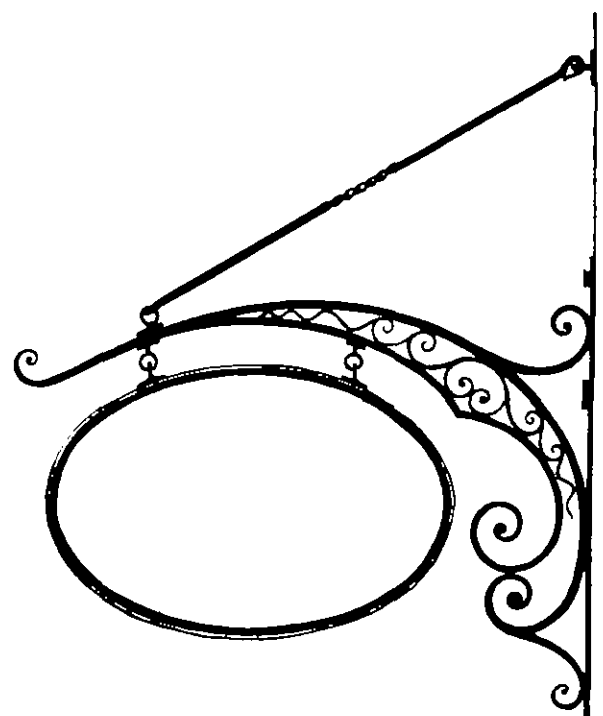

770

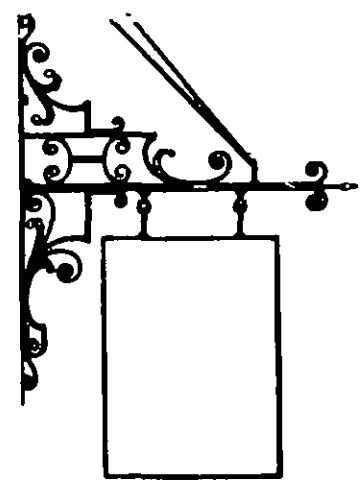

768

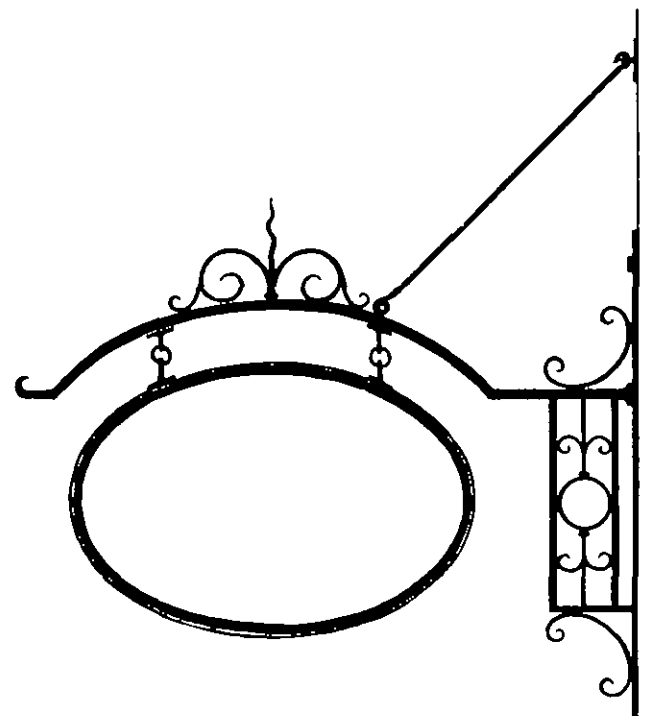

771

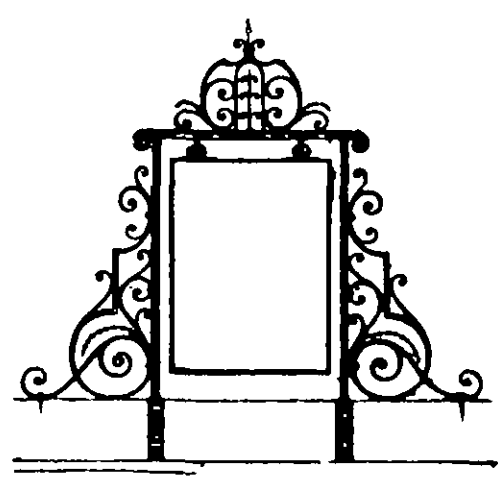

769

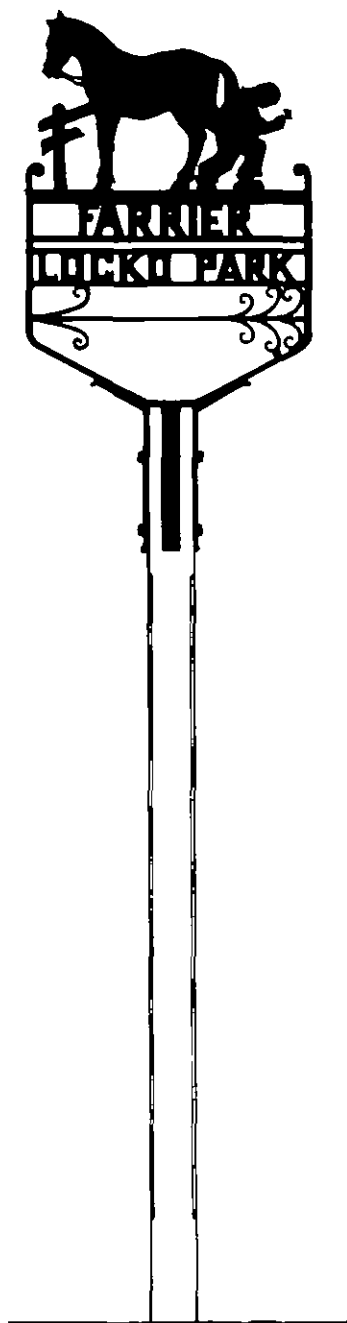
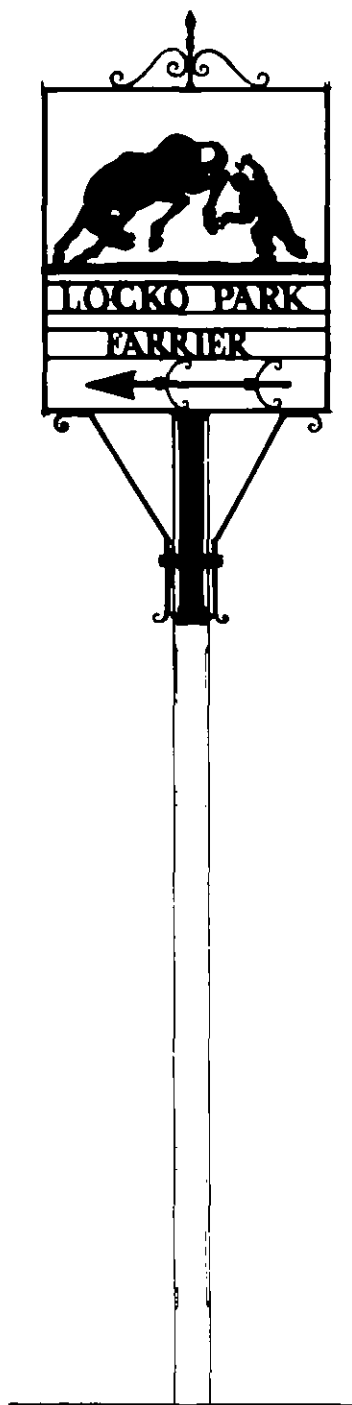

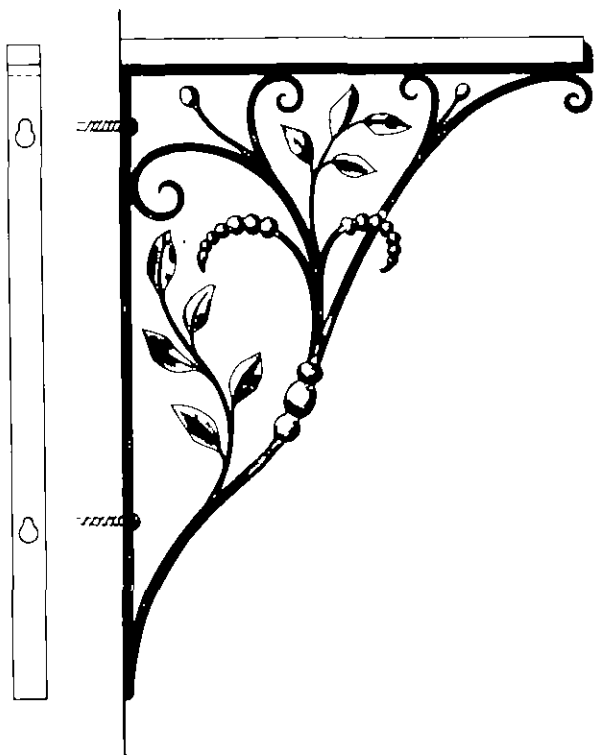

773

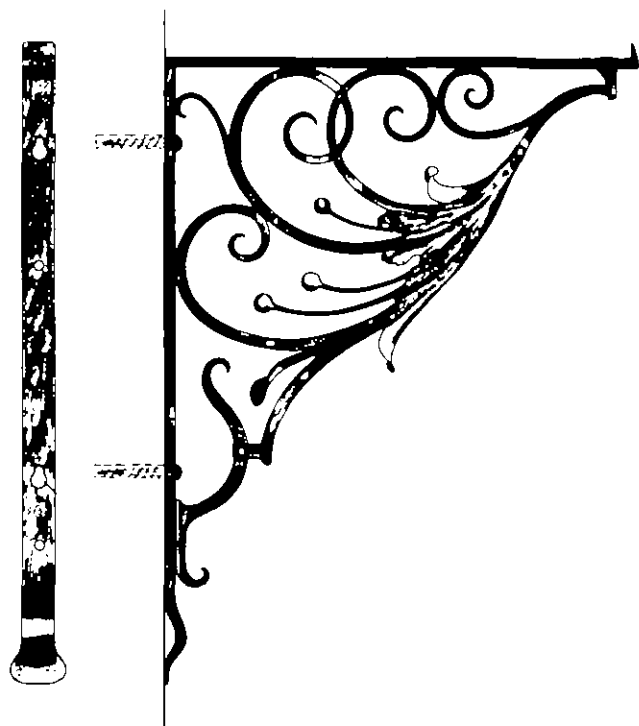

774

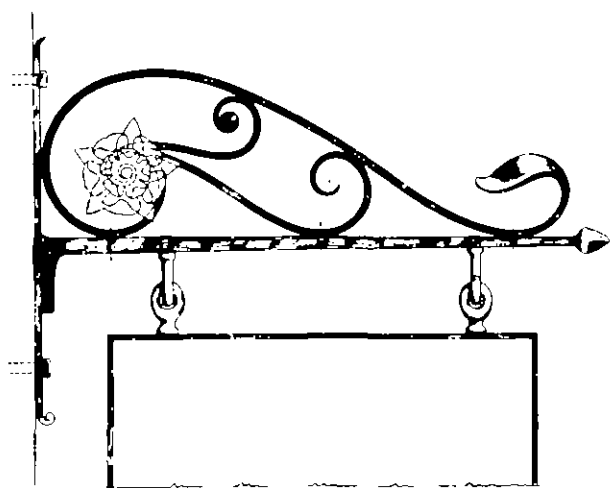

775

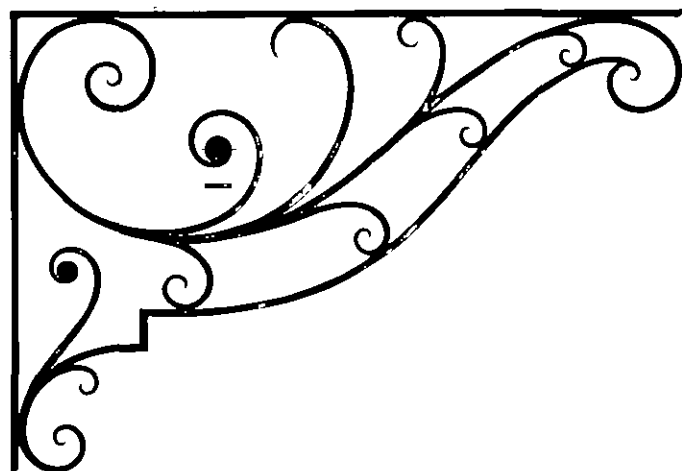

776

Lecterns

825	3'6"
826	3'0"
827	3'6"
828	2'6"

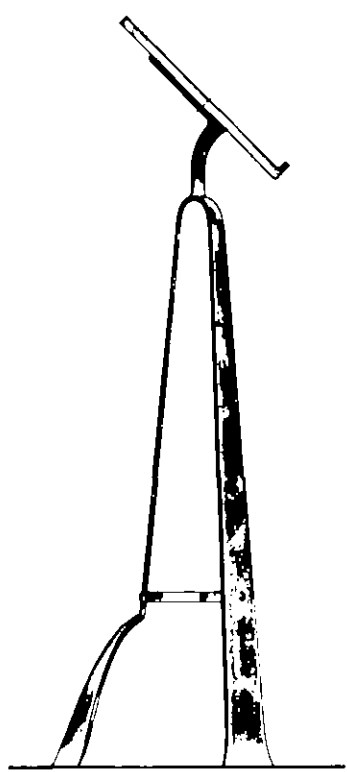

825

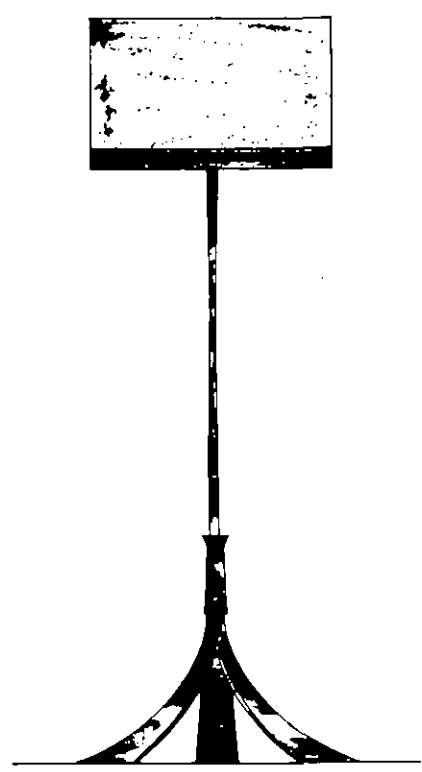

827

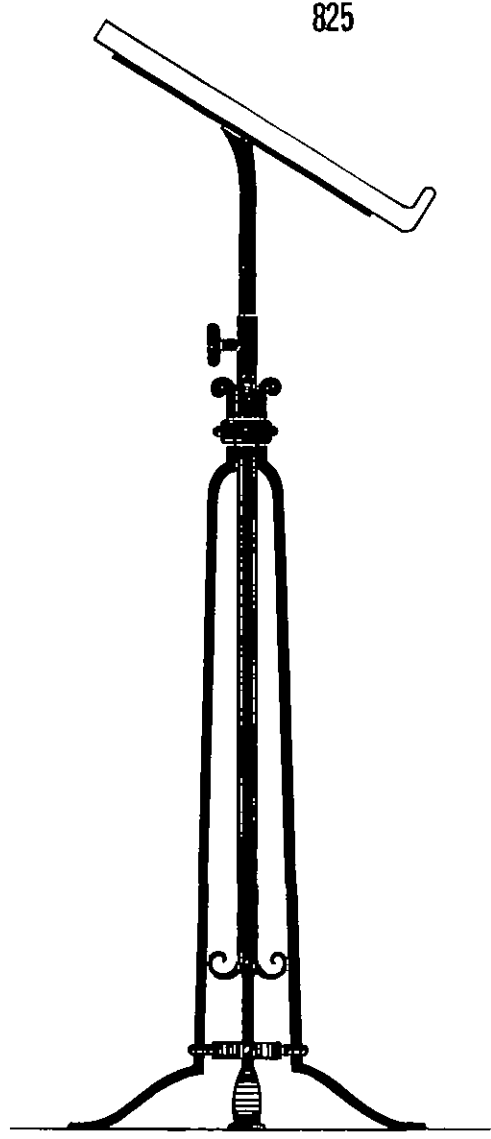

826

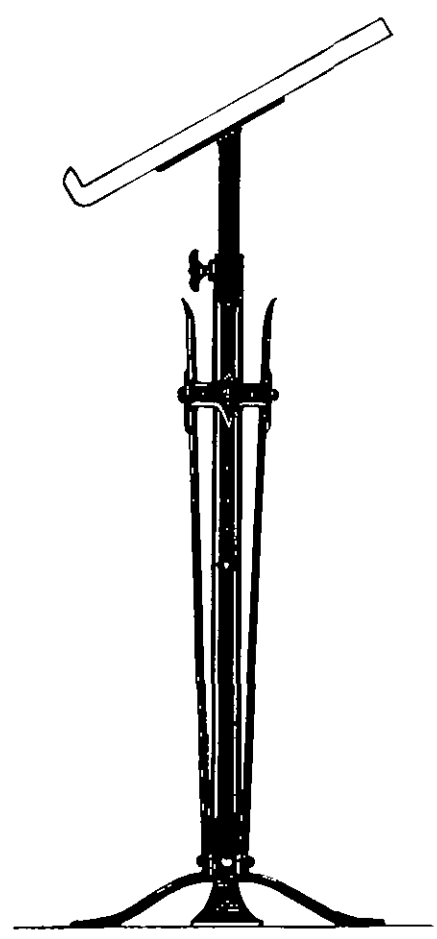

828

Weather Vanes

900	3'3" x 2'0"	946	2'2" x 1'2"	992	2'3" x 1'3"
901	4'2" x 2'4"	947	2'1" x 1'1"	993	2'5" x 10 $\frac{1}{2}$ "
902	3'0" x 2'4"	948	2'3" x 1'5"	994	{ 2'8" x 1'0" 1'10" x 10"
903	5'5" x 3'1"	949	2'0" x 1'5"	995	2'0" x 1'2"
904	5'0" x 2'6"	950	2'6" x 1'7 $\frac{1}{2}$ "	996	3'0" x 1'3"
905	4'4" x 2'4"	951	2'0" x 1'4"	997	2'8" x 2'2"
906	5'5" x 2'6"	952	1'8" x 1'0"	998	3' x 1'3 $\frac{3}{8}$ "
907	1'11" x 1'9"	953	4'0" x 11 $\frac{1}{2}$ "	999	1'5" x 1'5"
908	{ 4'2" x 1'7" 3'0" x 1'0 $\frac{1}{2}$ "	954	2'11" x 2'2"	1000	2'10" x 1'7"
909	3'7" x 1'8"	955	1'9" x 1'3"		
910	1'6" x 1'4"	956	3'0" x 2'0"		
911	1'11" x 1'9"	957	3'0" x 9 $\frac{1}{2}$ "		
912	2'0" x 1'9"	958	3'5" x 1'6"		
913	1'4" x 1'5"	959	2'1" x 1'8"		
914	2'0" x 1'0"	960	1'9" x 1'1"		
915	2'4" x 2'0"	961	2'4" x 1'6"		
916	2'0" x 1'8"	962	2'7" x 2'4"		
917	3'9 $\frac{1}{2}$ " x 1'5"	963	2'0" x 2'0"		
918	1'5" x 1'5"	964	2'2" x 1'10 $\frac{1}{2}$ "		
919	2'3" x 1'10"	965	3'1" x 1'5"		
920	2'8" x 1'4"	966	2'2" x 1'1 $\frac{1}{2}$ "		
921	1'4" x 1'0"	967	2'2" x 1'4"		
922	1'10 $\frac{1}{2}$ " x 1'8"	968	2'6" x 1'7 $\frac{1}{2}$ "		
923	3'4" x 1'6 $\frac{1}{2}$ "	969	2'9" x 1'2"		
924	2'3" x 1'4"	970	2'8" x 1'0"		
925	2'1" x 1'0"	971	2'1" x 1'7"		
926	3'4" x 1'4"	972	2'4" x 1'5"		
927	2'6" x 1'6"	973	2'4" x 1'6"		
928	2'8" x 1'3"	974	2'0" x 1'3 $\frac{1}{2}$ "		
929	2'3" x 1'11"	975	1'11" x 11 $\frac{1}{2}$ "		
930	4'2" x 10"	976	2'1" x 1'2"		
931	10 $\frac{1}{2}$ " x 10 $\frac{1}{2}$ "	977	2'0" x 1'3"		
932	2'1" x 1'10 $\frac{1}{2}$ "	978	2'8" x 1'1"		
933	2'4" x 2'2"	979	3'0" x 1'4"		
934	2'7" x 1'3"	980	2'7 $\frac{1}{2}$ " x 1'0"		
935	1'3" x 8 $\frac{1}{2}$ "	981	2'2" x 1'7"		
936	2'6" x 1'6 $\frac{1}{2}$ "	982	2'10" x 1'7"		
937	2'3" x 1'2"	983	3'0" x 1'1"		
938	2'9" x 1'6"	984	2'6" x 2'6"		
939	1'11" x 1'6"	985	1'5 $\frac{1}{2}$ " x 1'1 $\frac{1}{2}$ "		
940	2'3" x 1'10"	986	4'4" x 9"		
941	11" x 11"	987	2'10" x 1'1"		
942	2'1 $\frac{1}{2}$ " x 10 $\frac{1}{2}$ "	988	2'3"		
943	1'11" x 10"	989	2'4" x 1'1"		
944	3'0" x 2'4"	990	2'5" x 1'0"		
945	2'6" x 1'5"	991	2'0 $\frac{1}{2}$ " x 1'1 $\frac{1}{2}$ "		

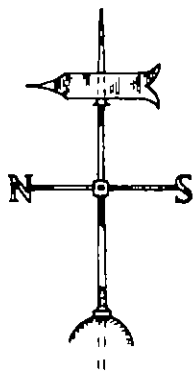

900

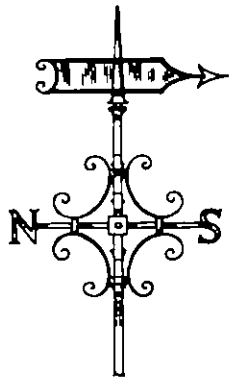

902

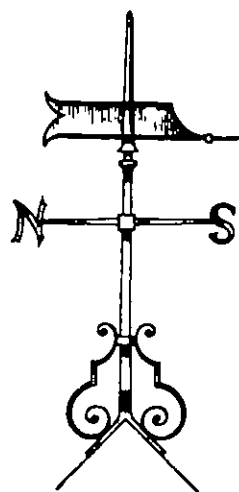

905

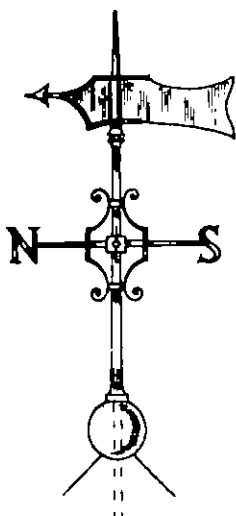

901

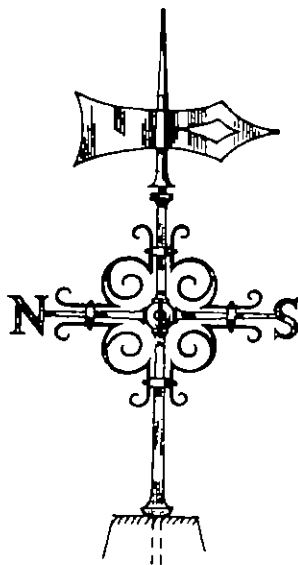

903

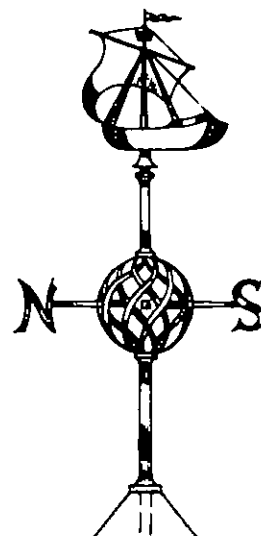

906

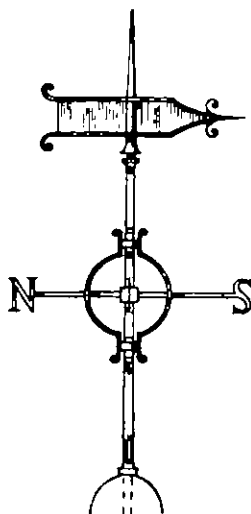

904

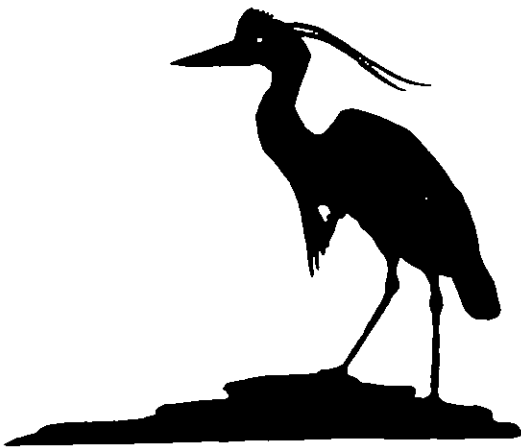

907



910



908

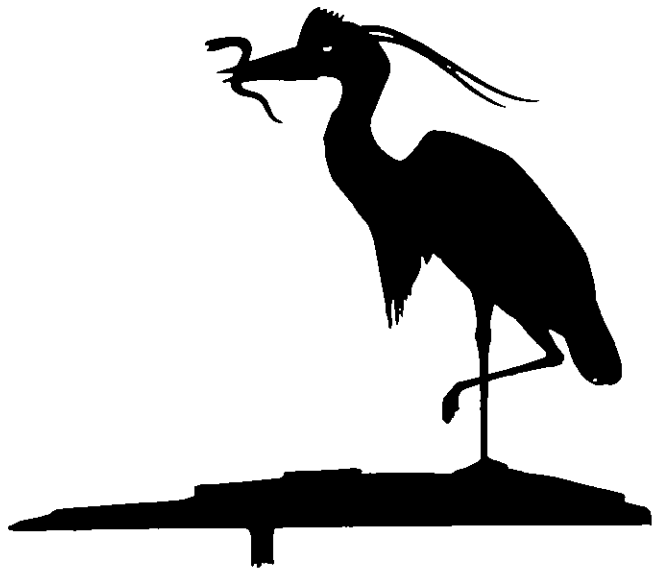

911

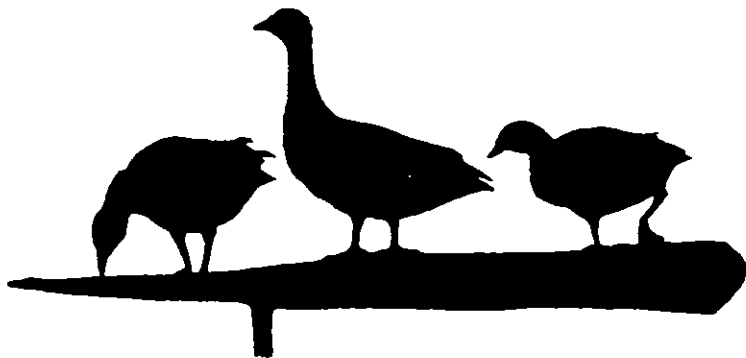

909



912

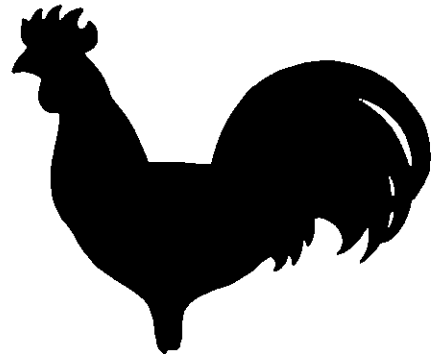

915

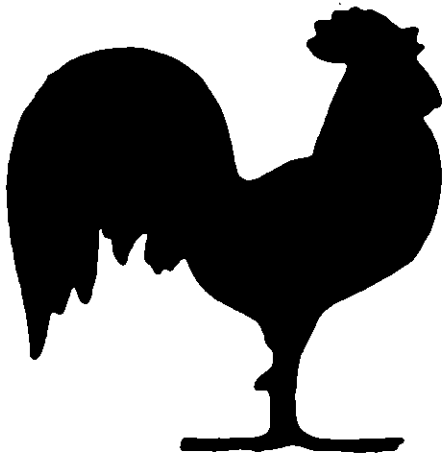

913



916

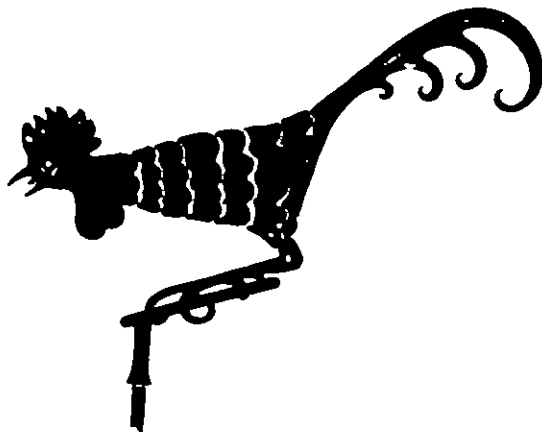

914



917

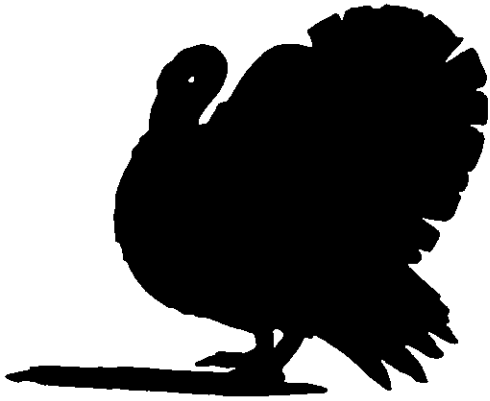

918

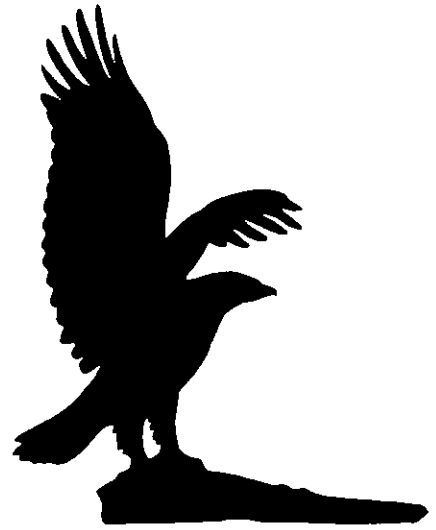

919

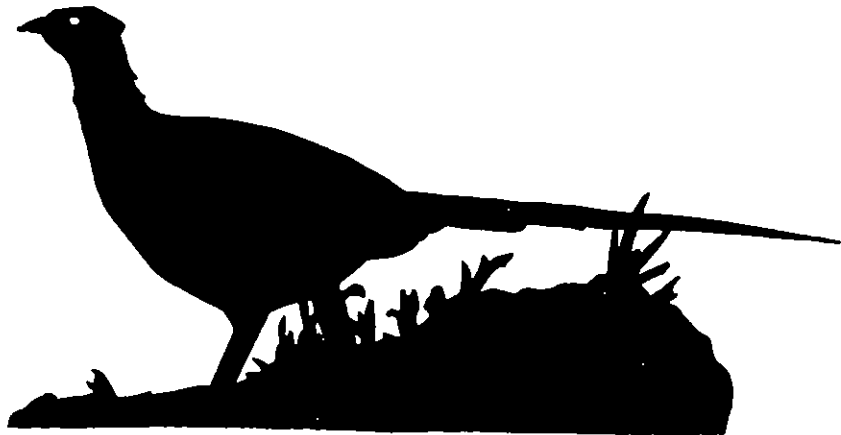

920



921

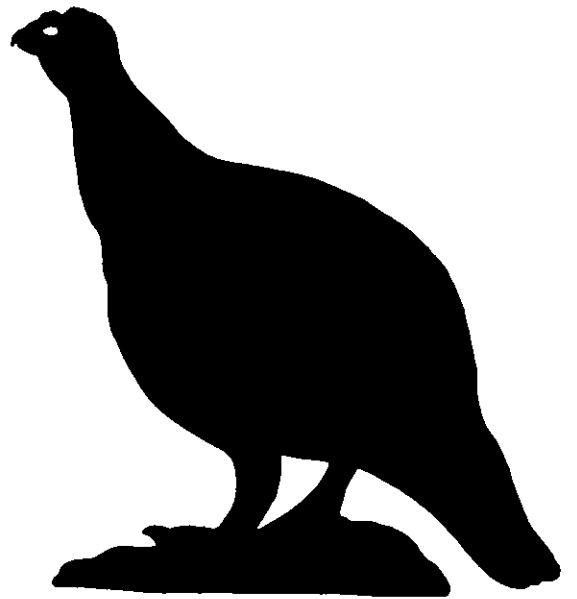

922

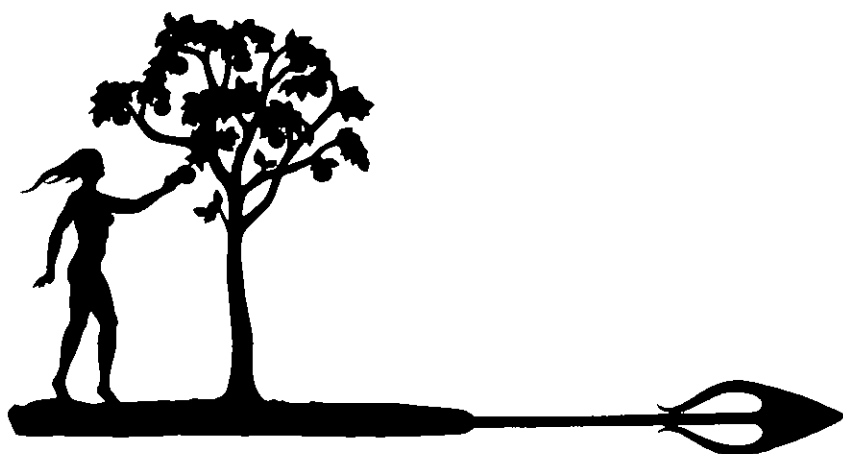

923



924



925



926

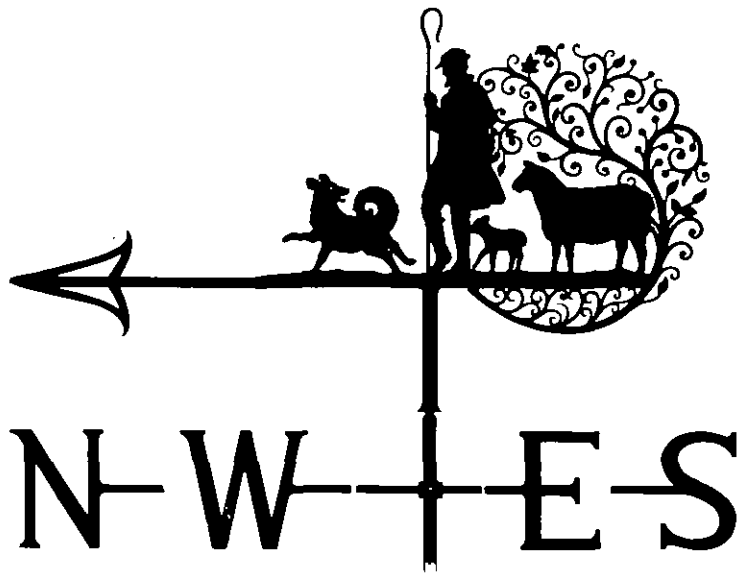

927

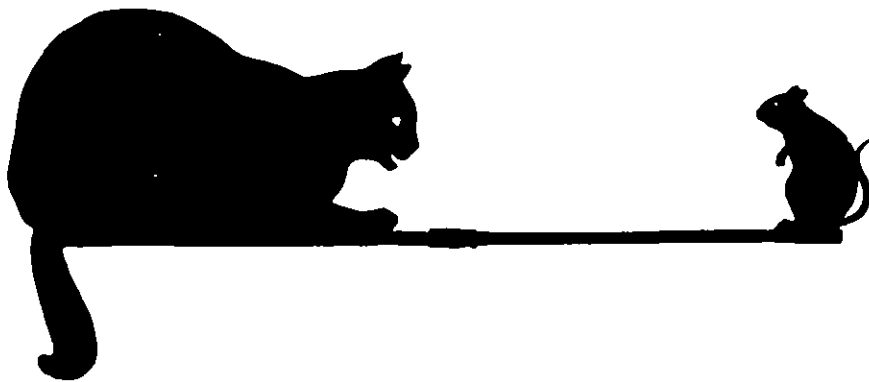

928



929



930



931



933



934



932

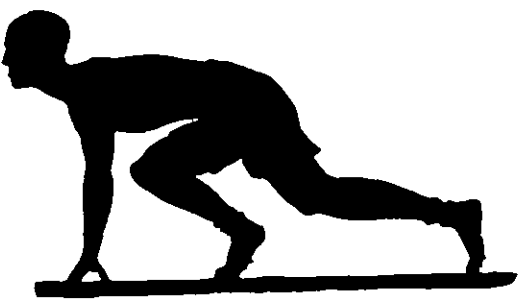

935



936

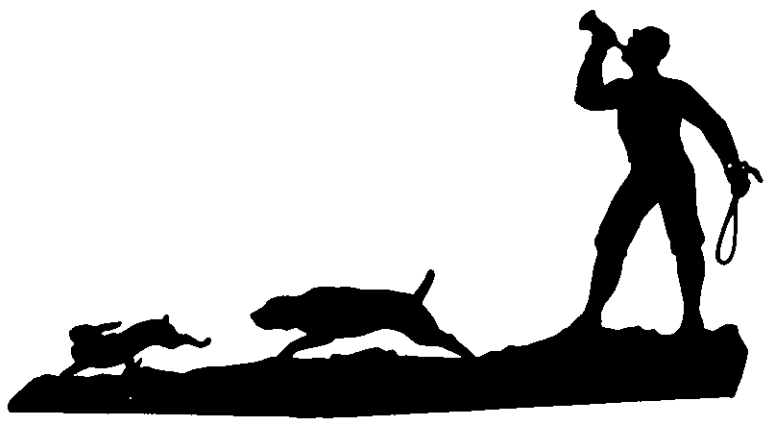

937

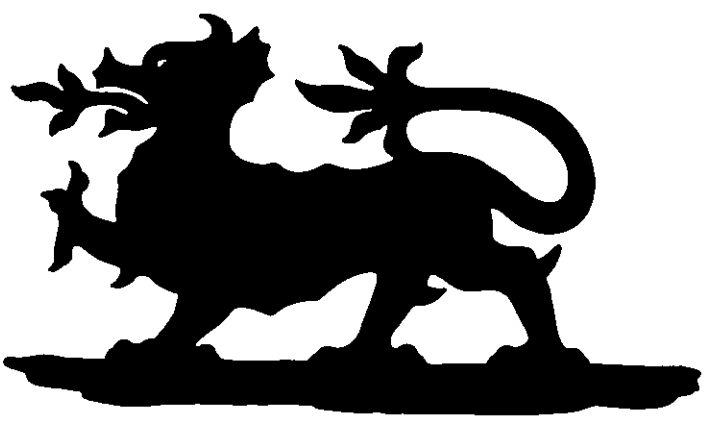

938



939

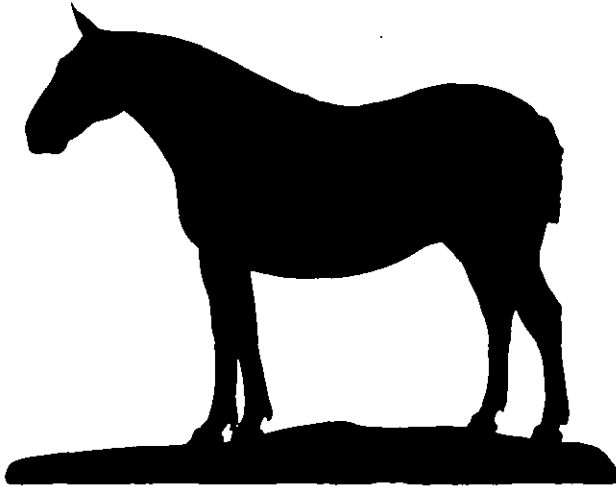

940

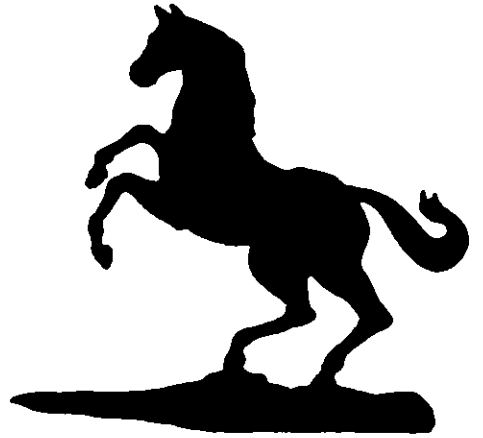

941

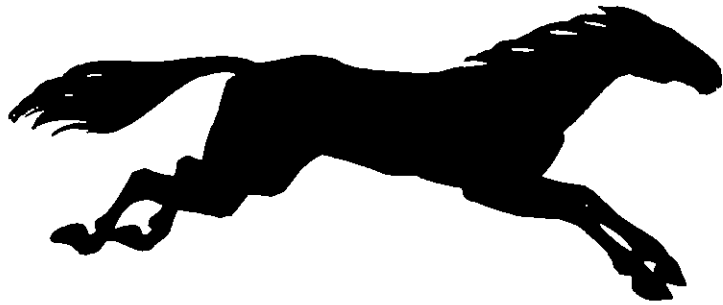

942

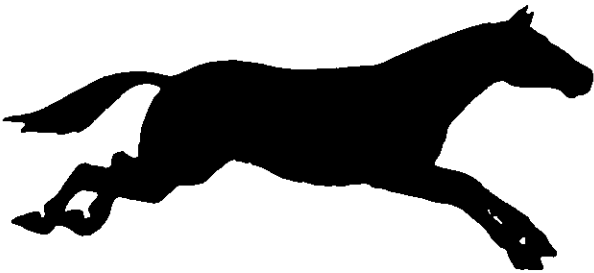

943

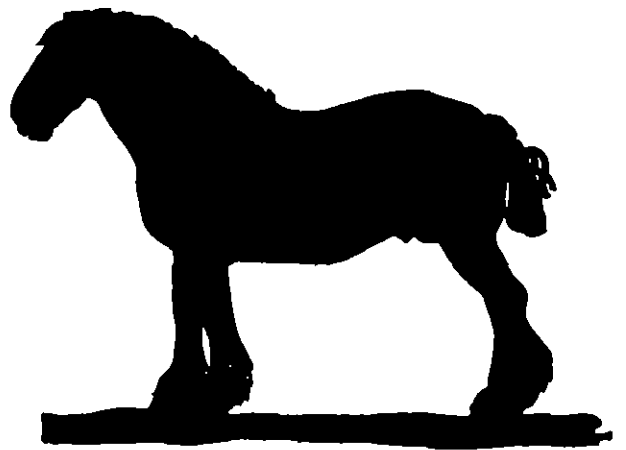

944

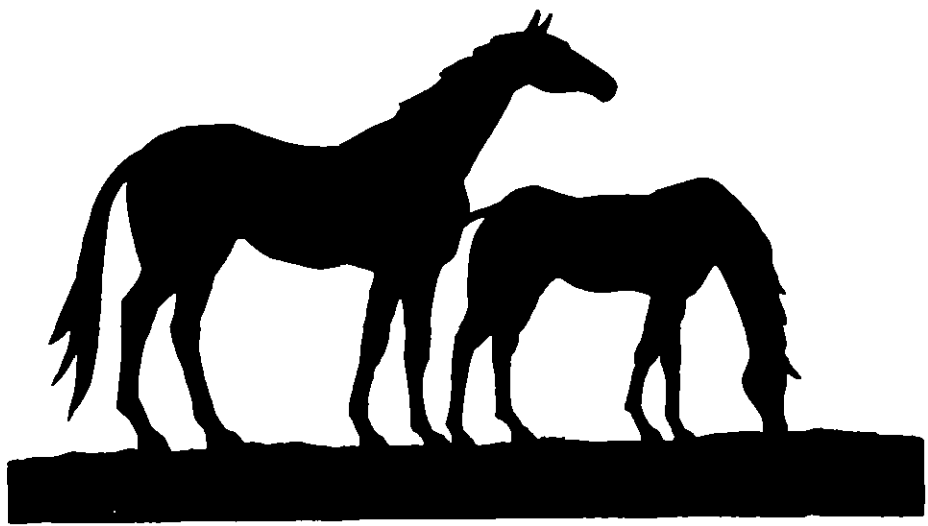

945

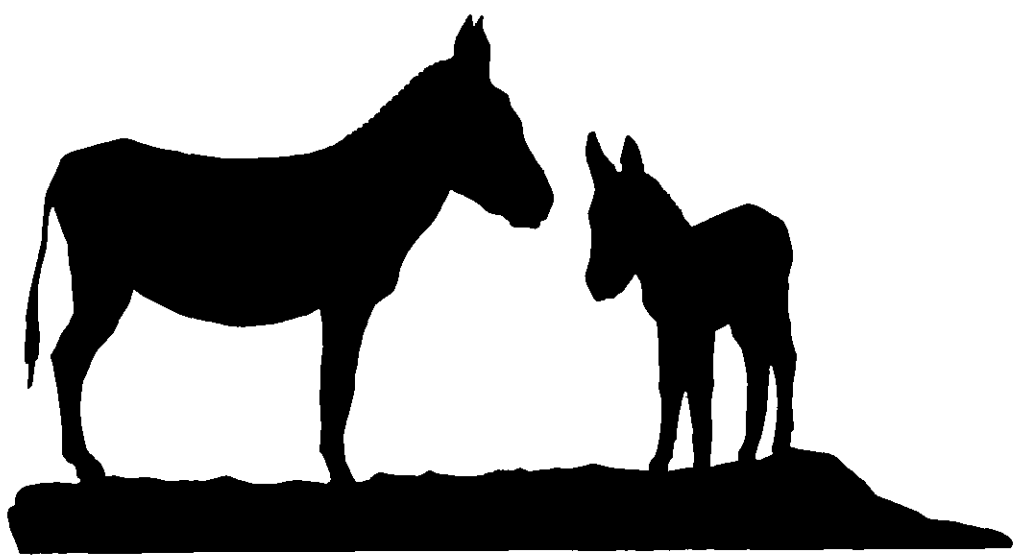

946

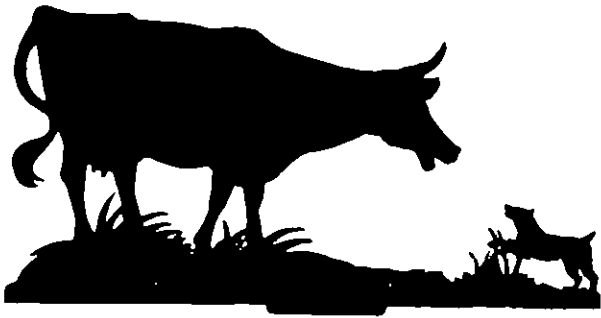

947

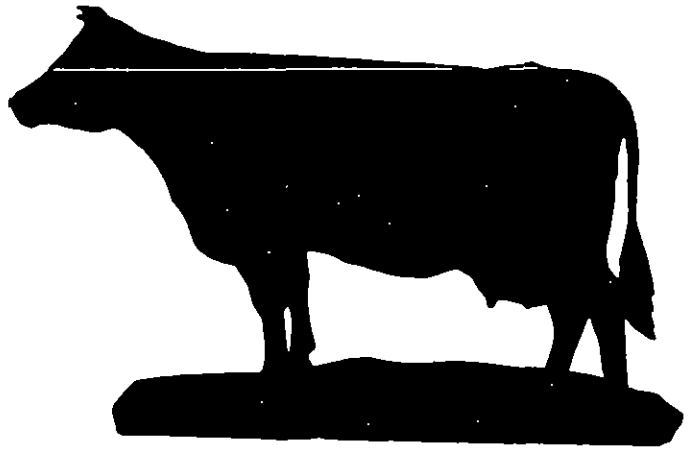

950

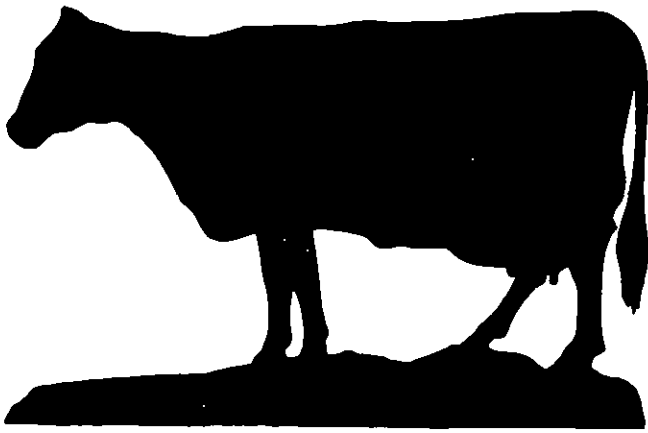

948

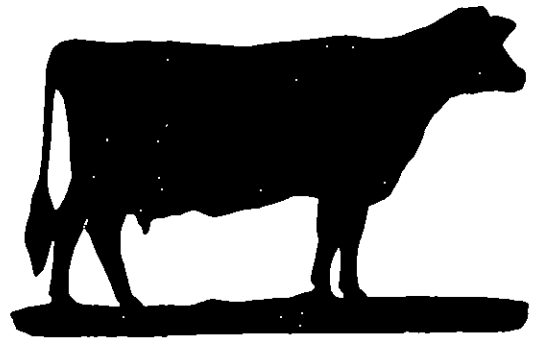

951

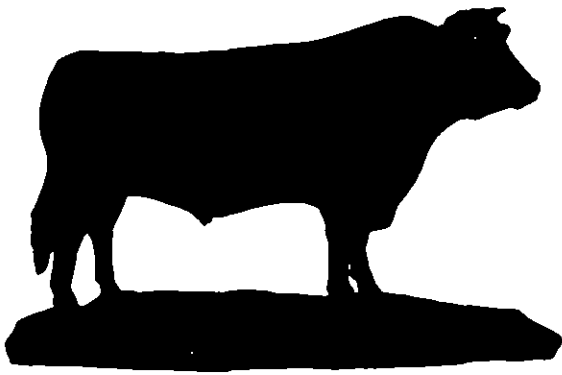

949

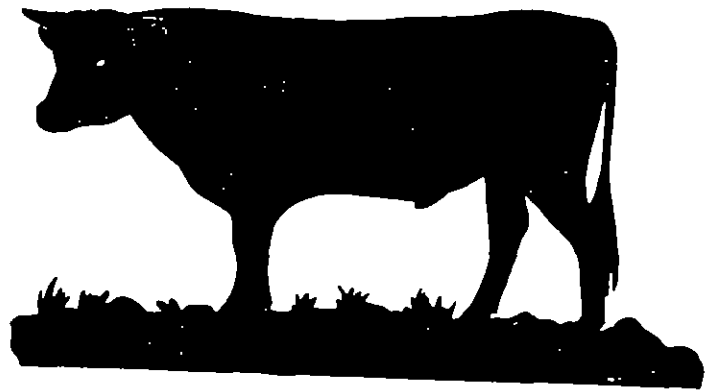

952

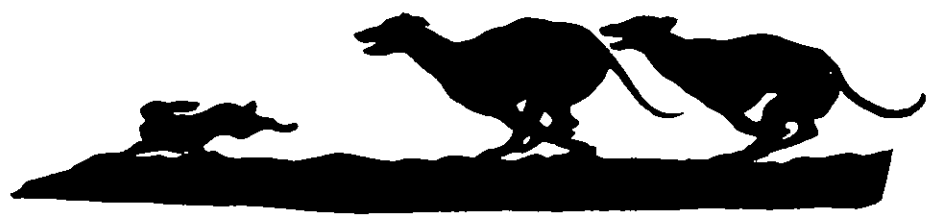

953

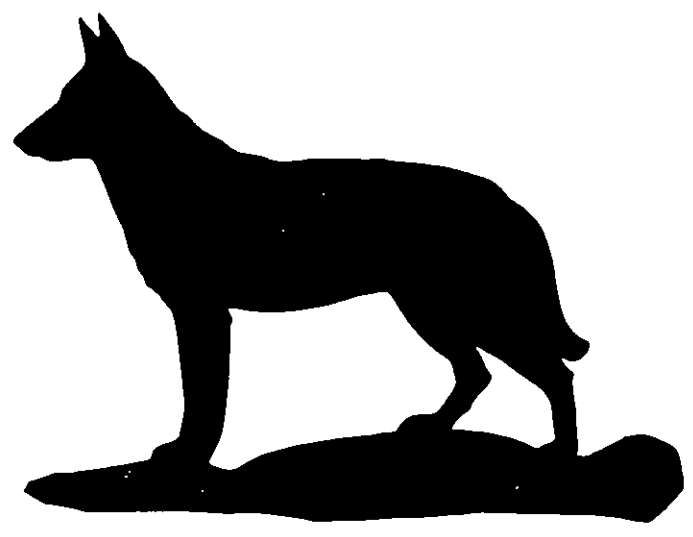

954



955



956

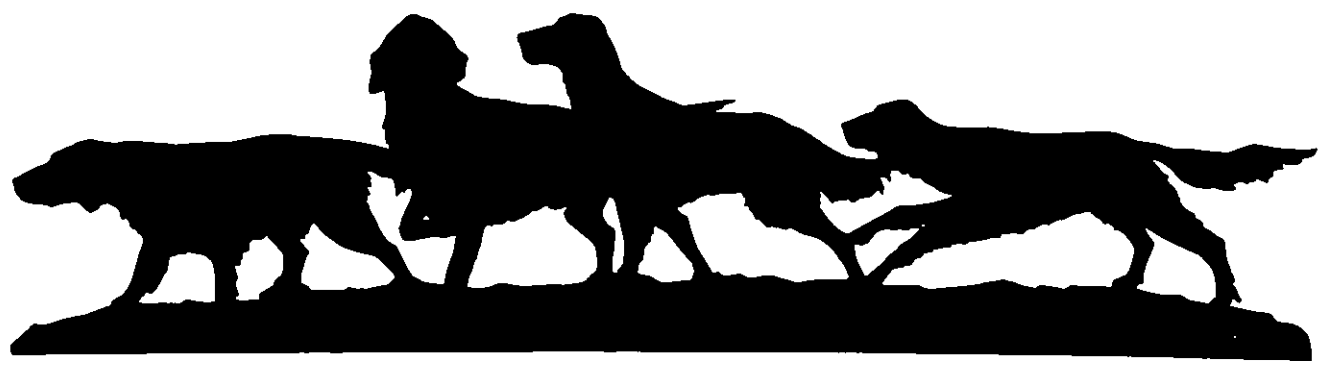

957



958

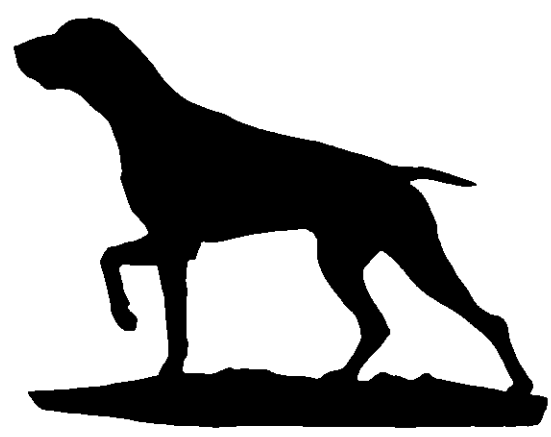

959

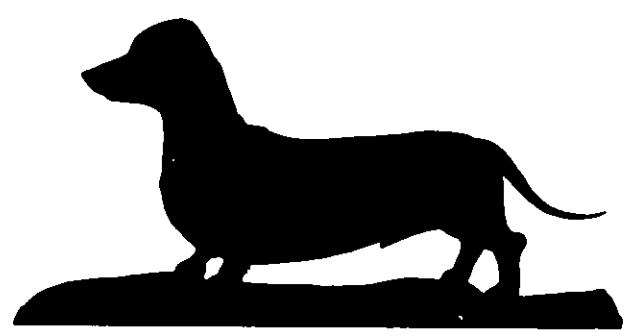

960

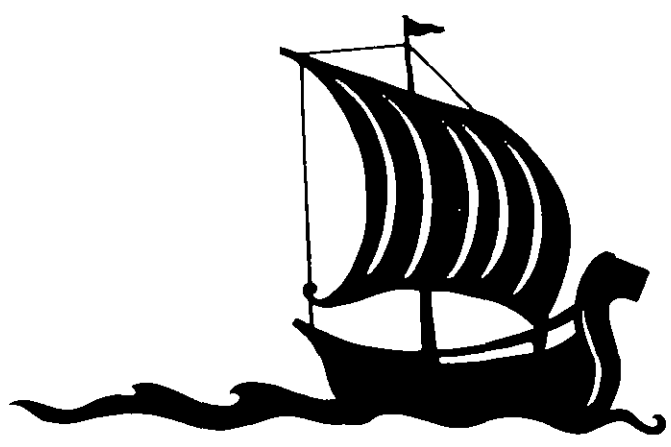

961

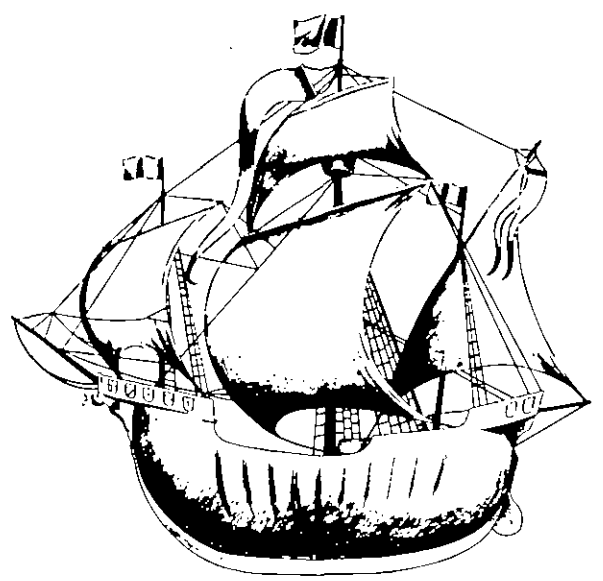

963

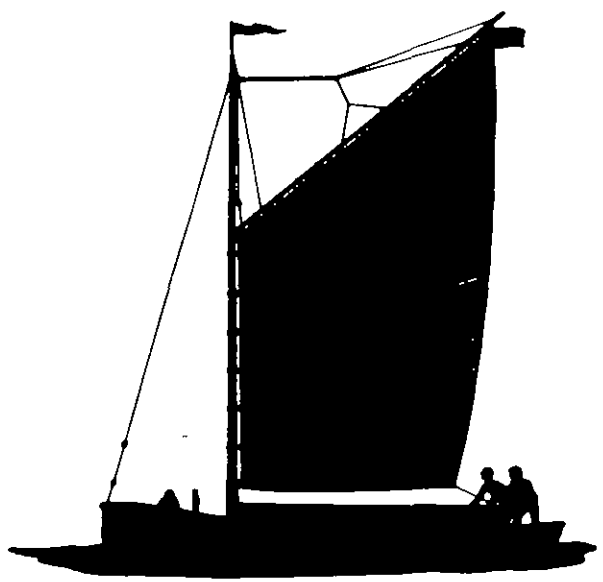

962



964

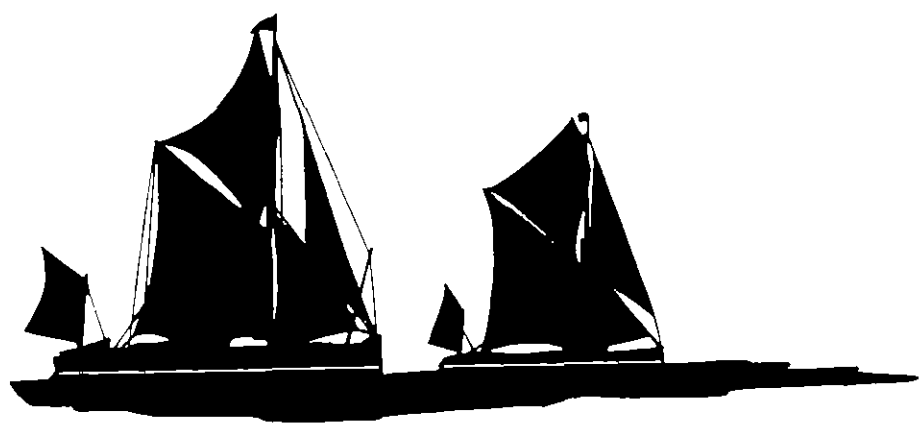

965

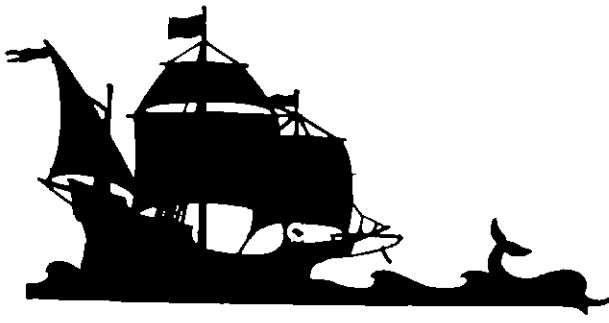

966

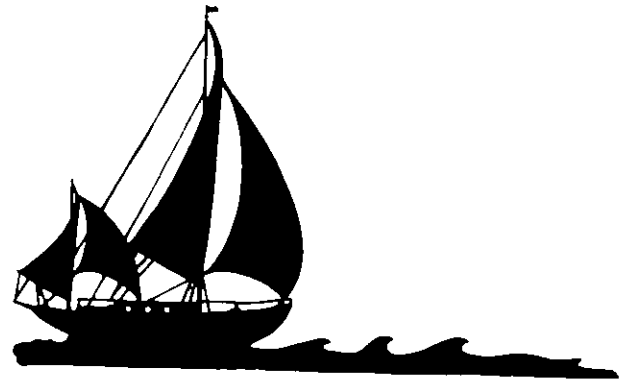

967

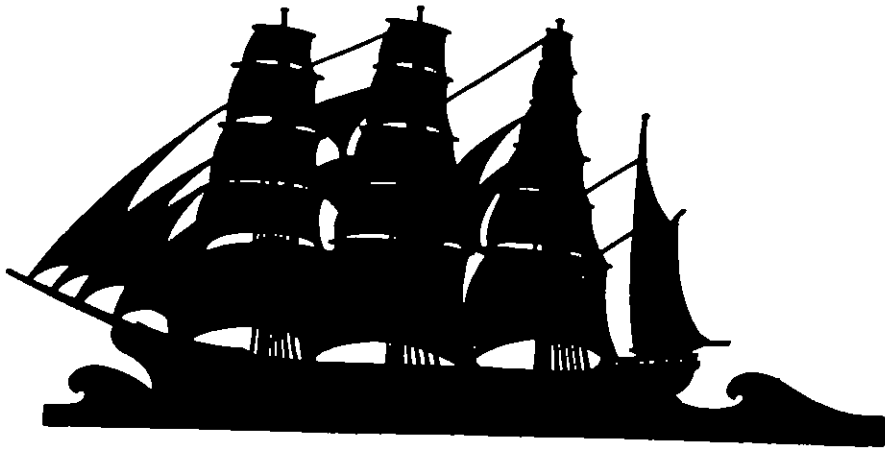

968

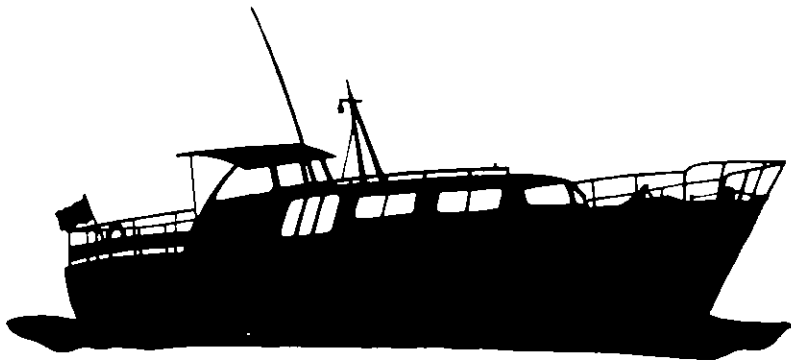

969

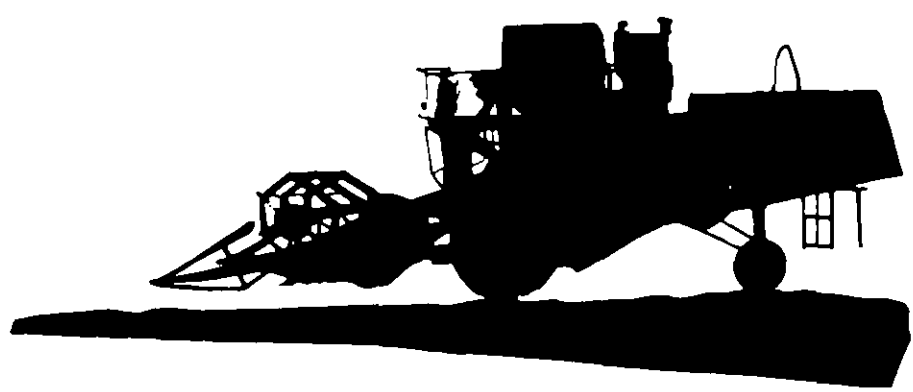

970

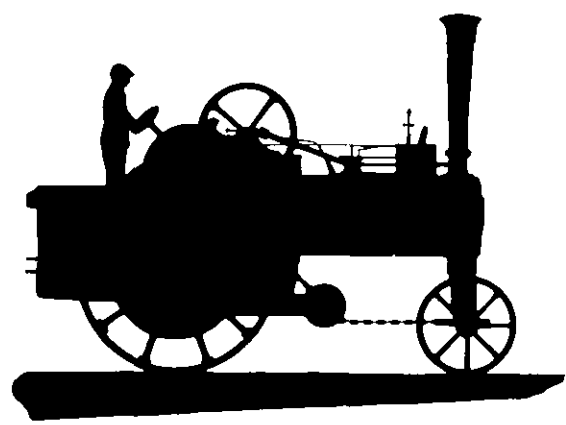

971

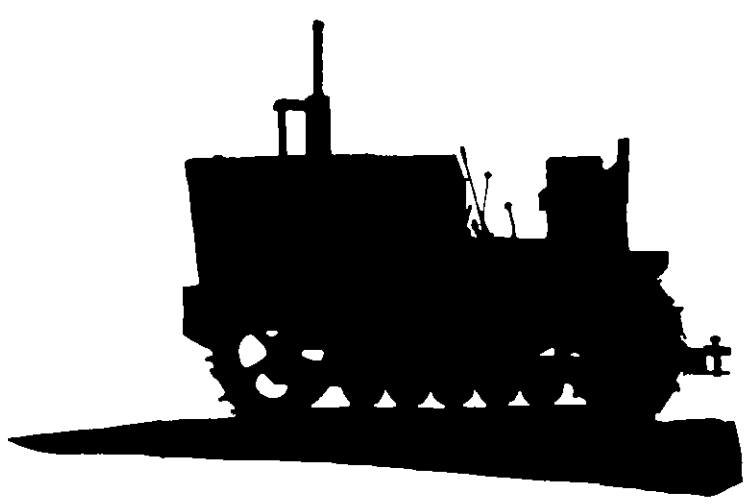

973

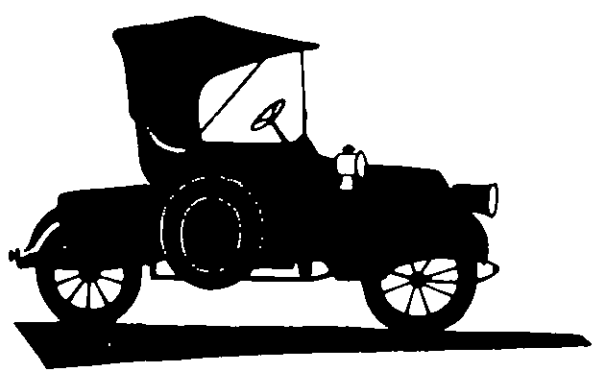

972

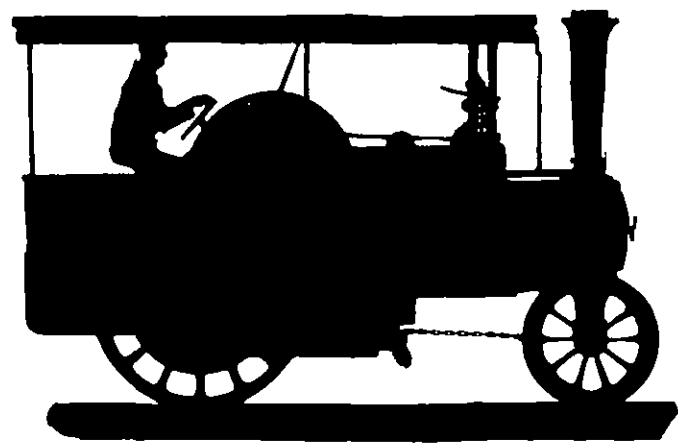

974

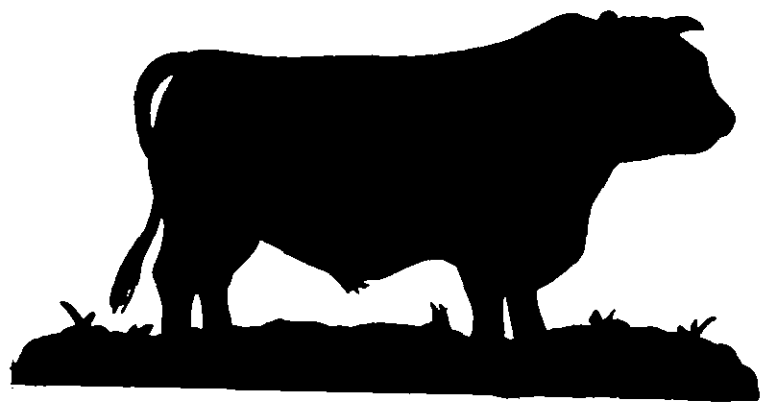

975

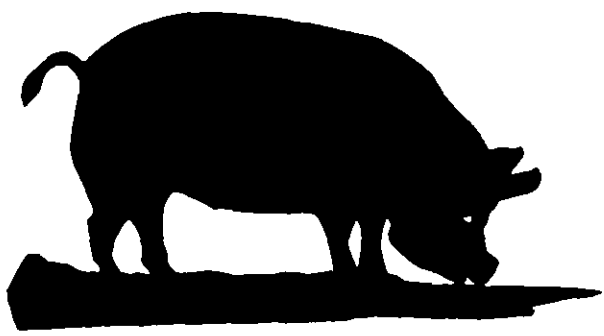

976

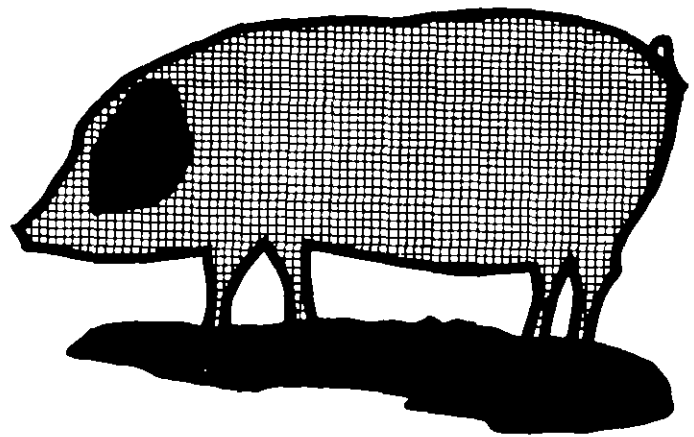

977

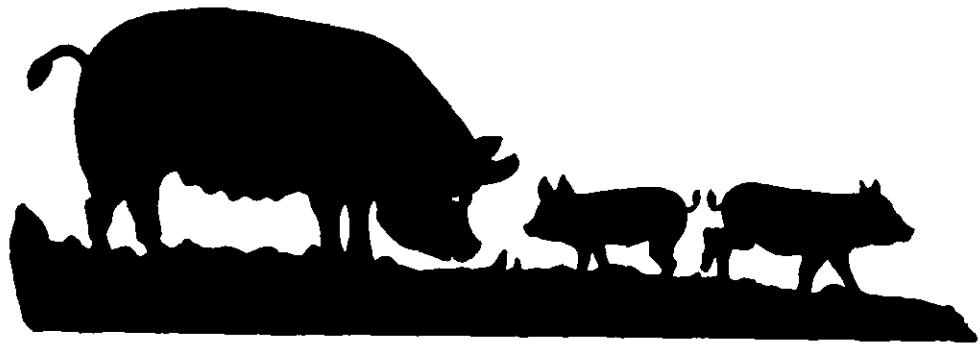

978

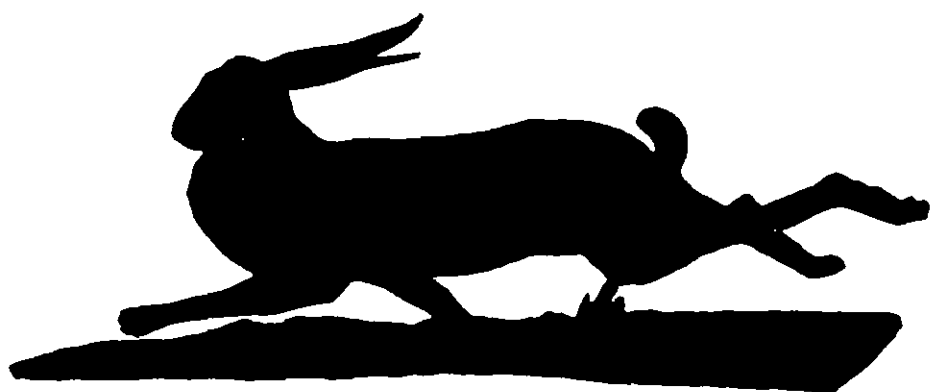

979



980

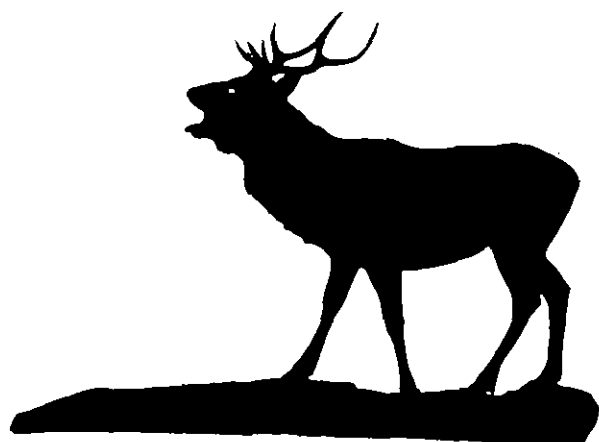

981

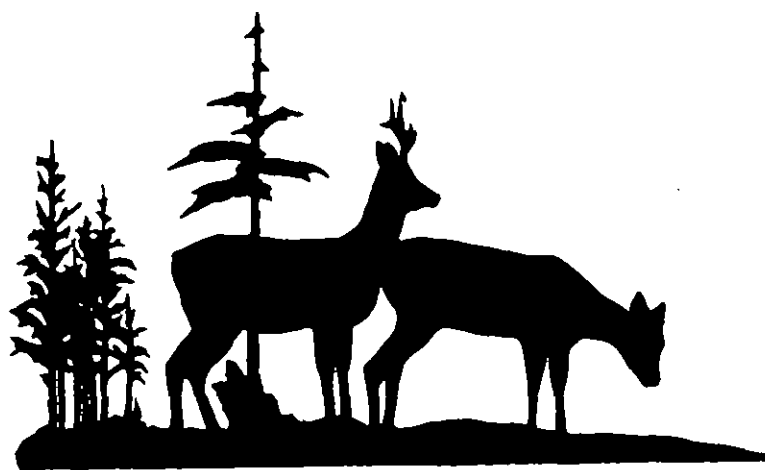

982

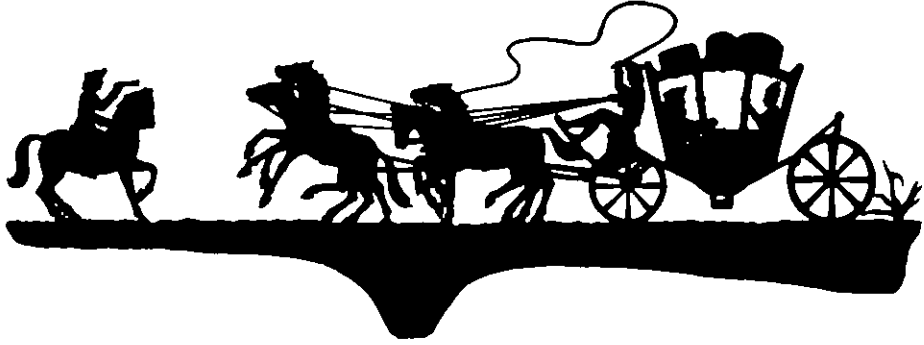

983



984

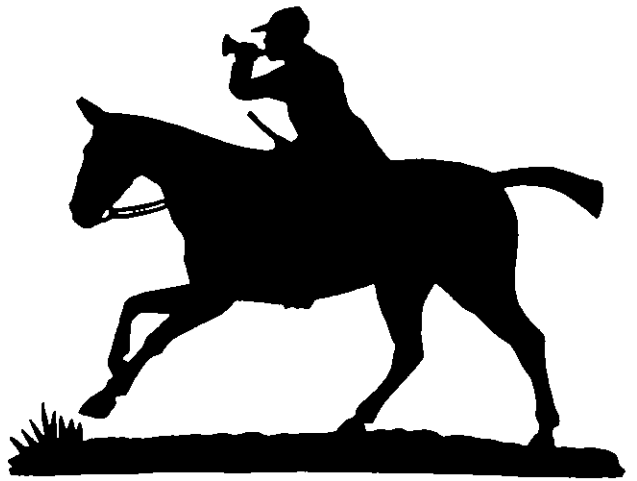

985

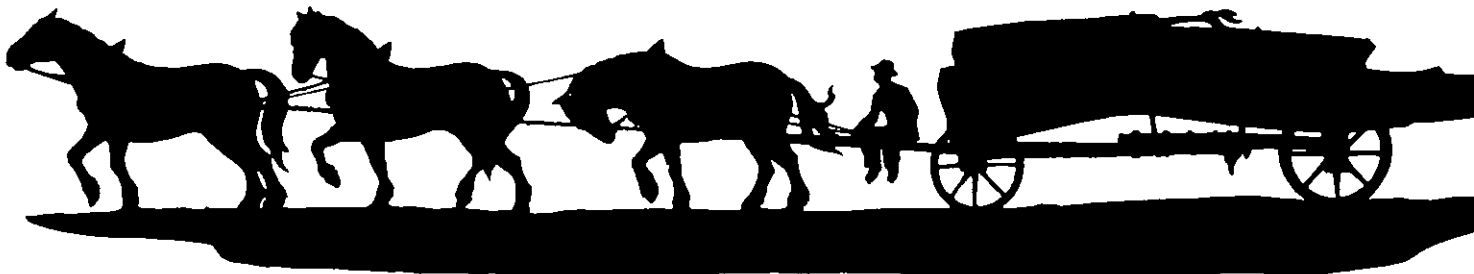

986

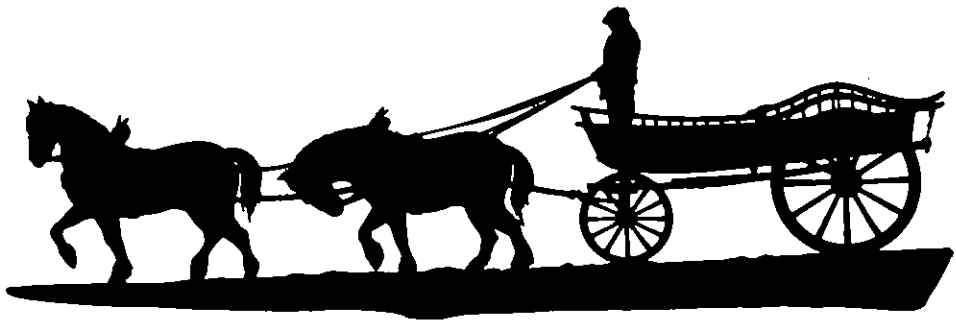

987



988

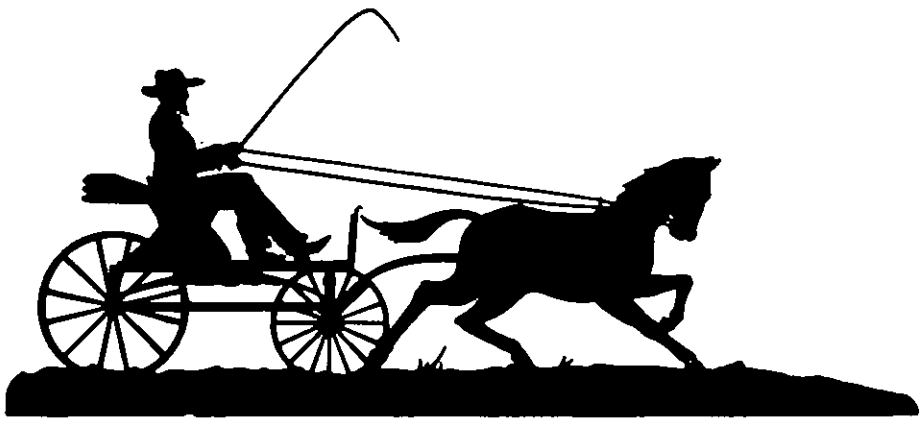

989

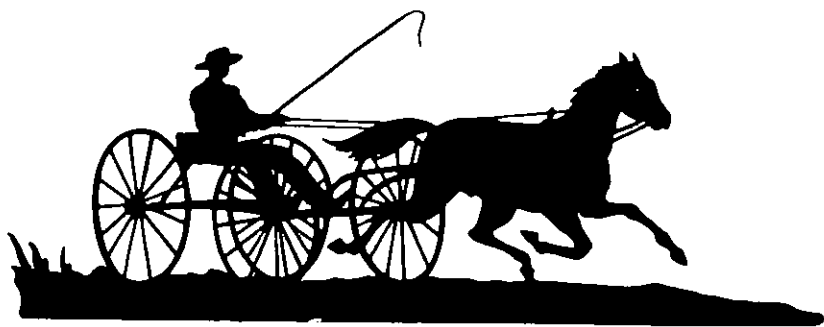

990



991

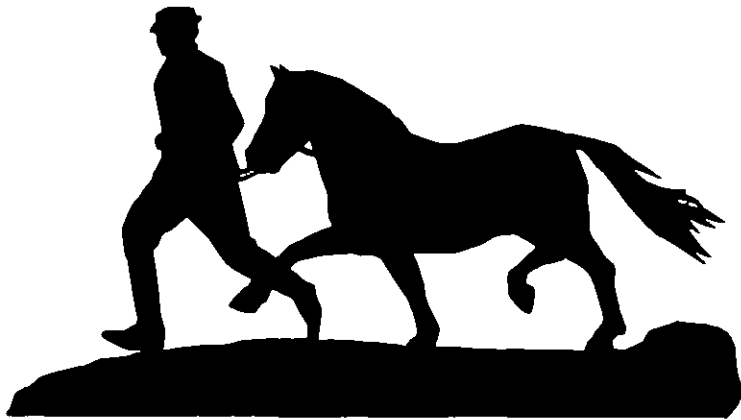

992

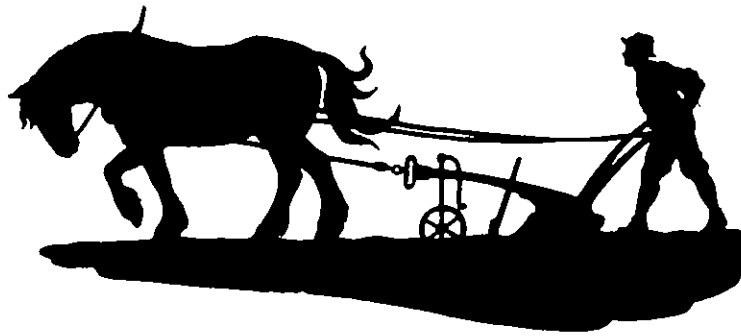

993

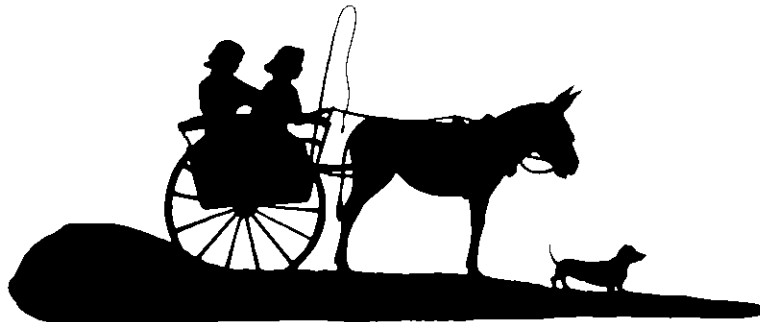

994



995



996



997



998



999



1000

Furniture

1100	1'6" x 1'1" dia.
1101	1'4 $\frac{1}{2}$ "
1102	6'4"
1103	3'4" x 2'6 $\frac{1}{2}$ "
1104	1'4 $\frac{1}{2}$ "
1105	1'4 $\frac{1}{8}$ "
1106	1'8 $\frac{1}{2}$ "
1107	2'5"

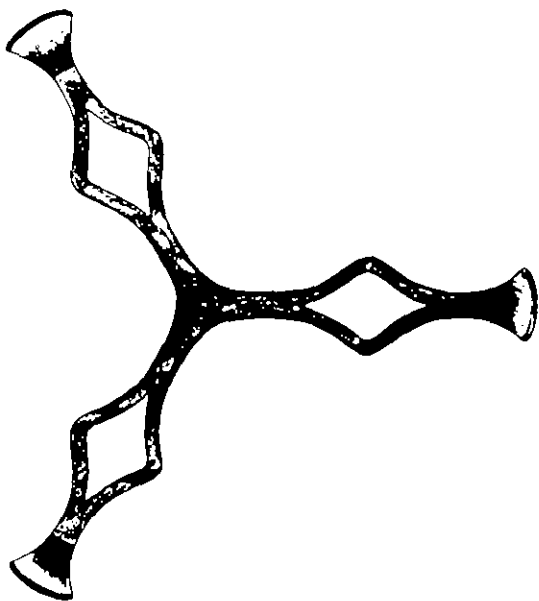
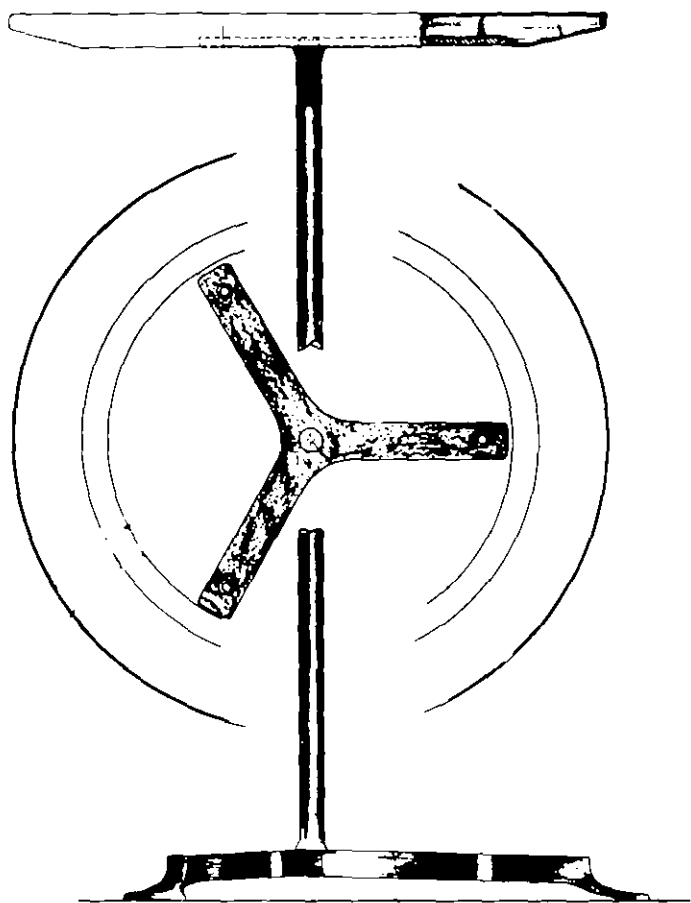

1100

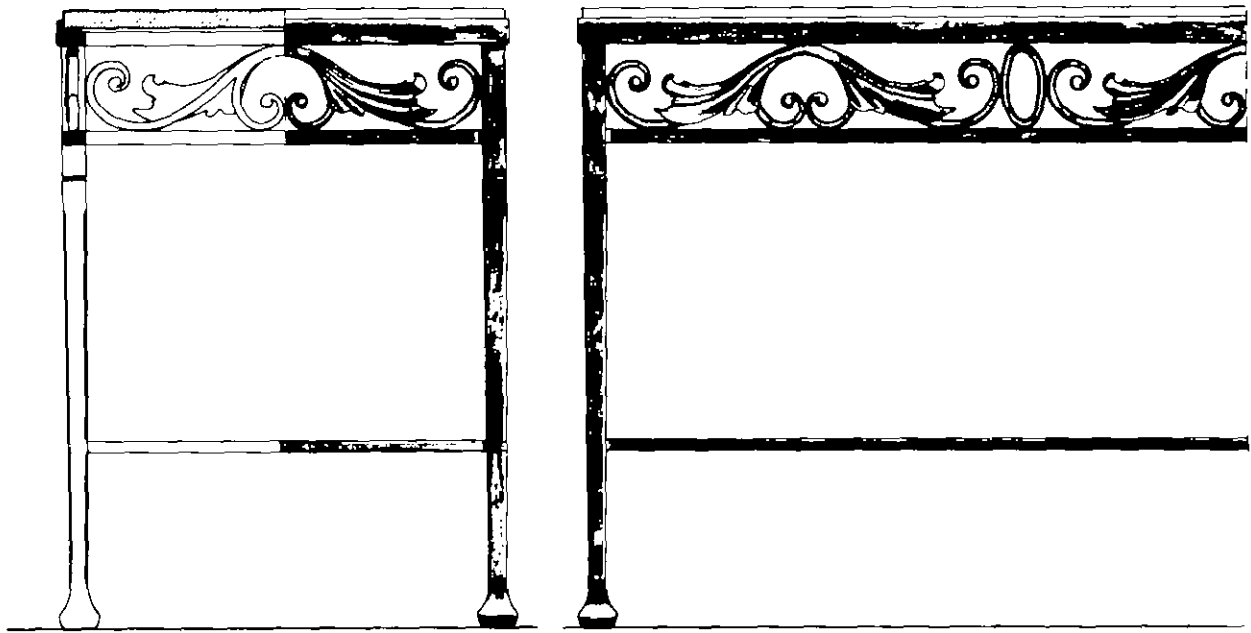

1101

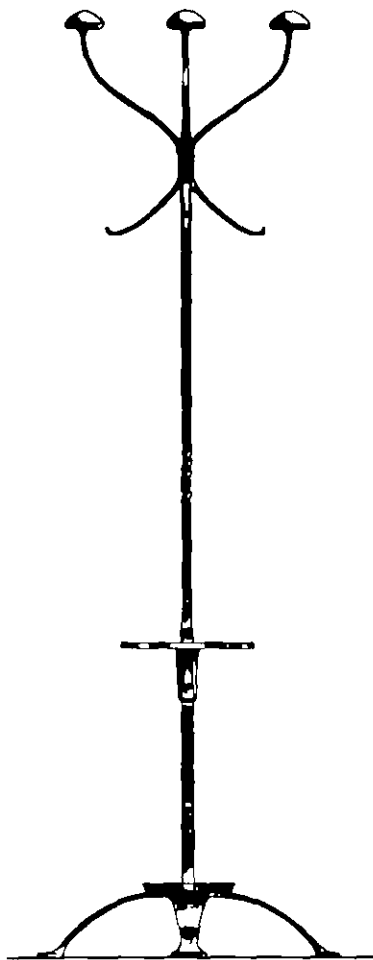

1102

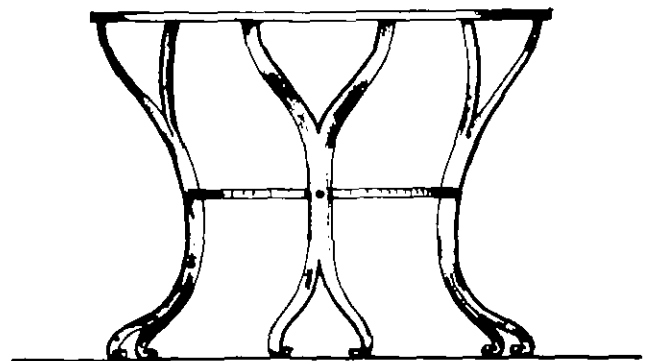
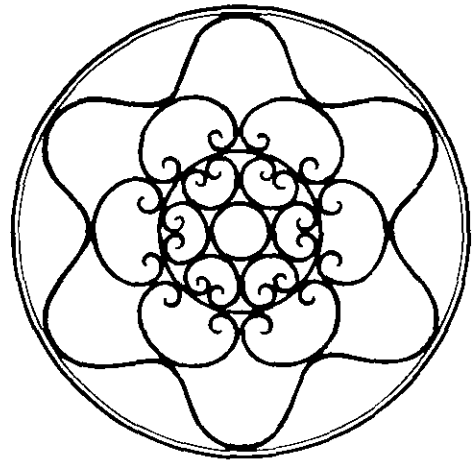

1103

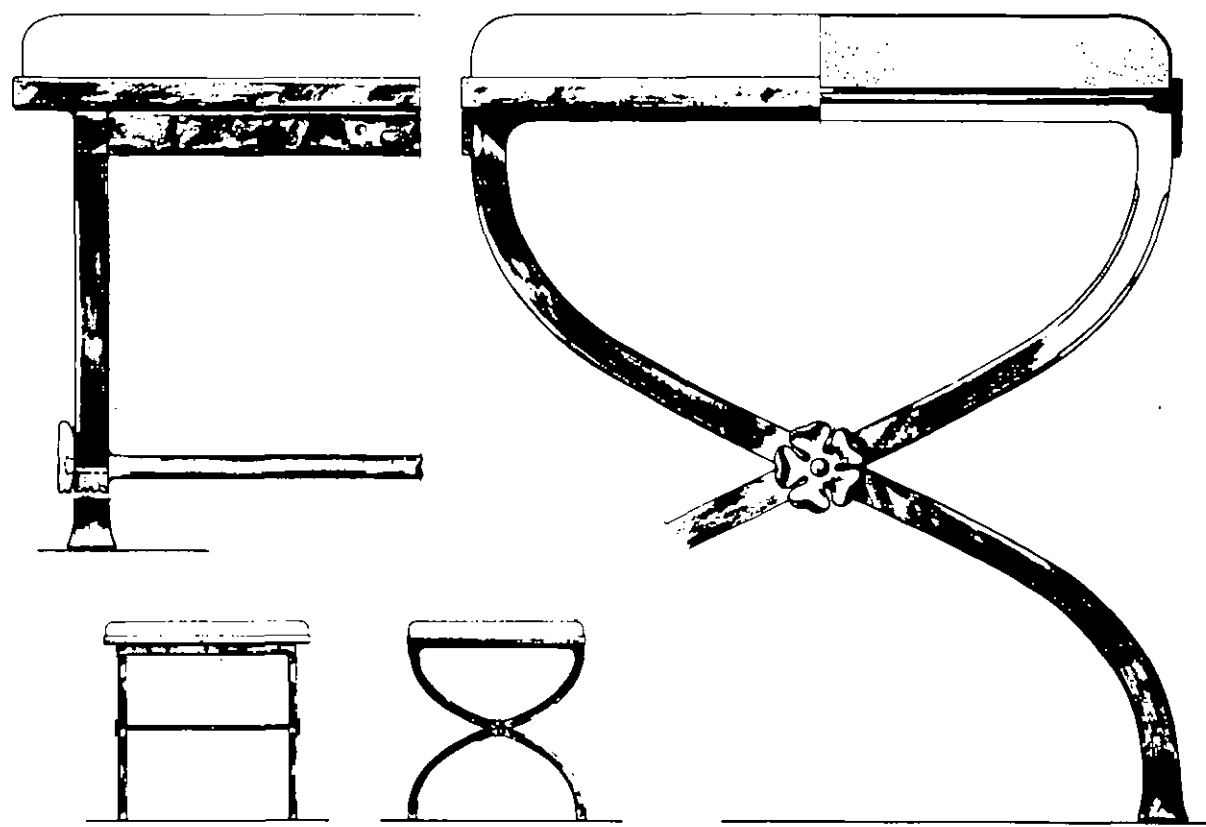

1104

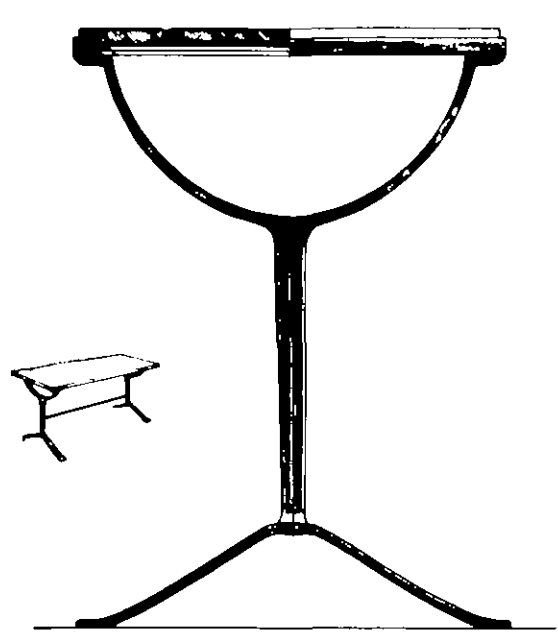

1105

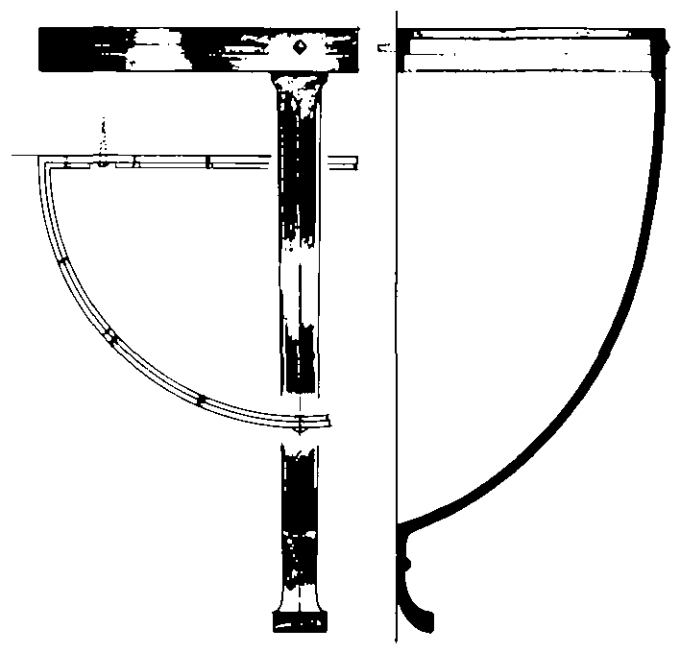

1106

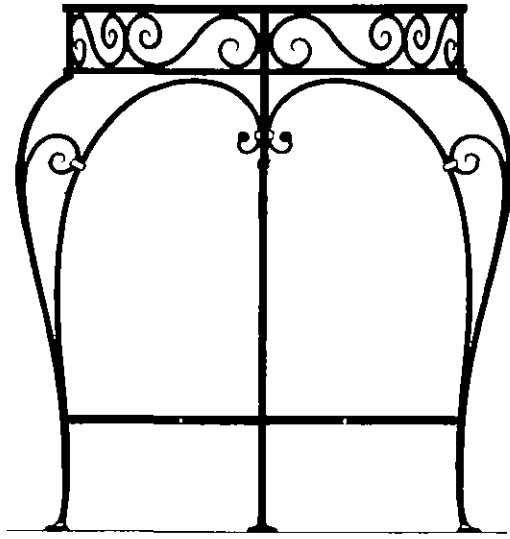

1107

Sundials

1150	1'1½"
1151	3'6"
1152	3'7"
1153	3'0"
1154	2'6½"
1155	1'3"

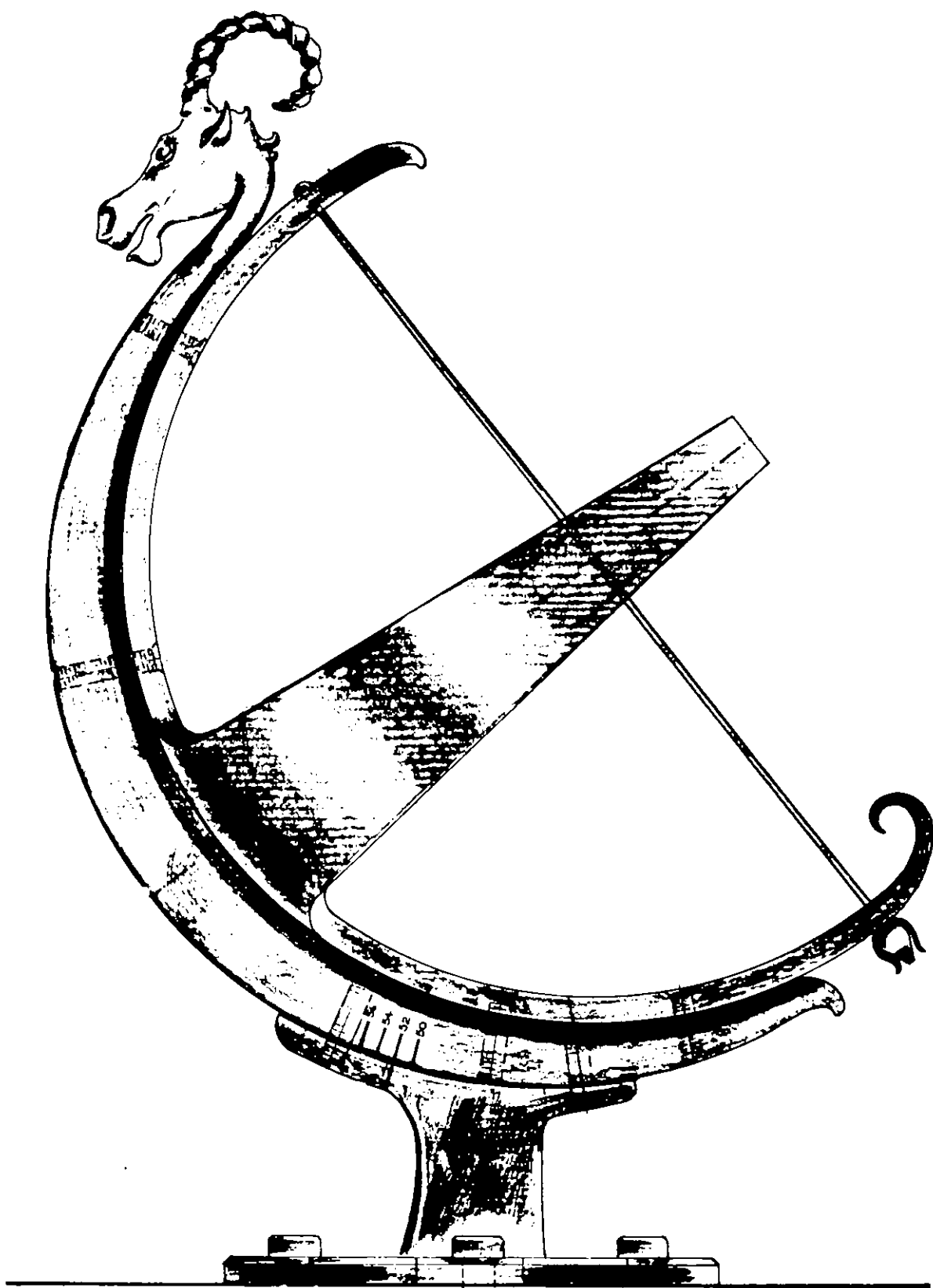

1150

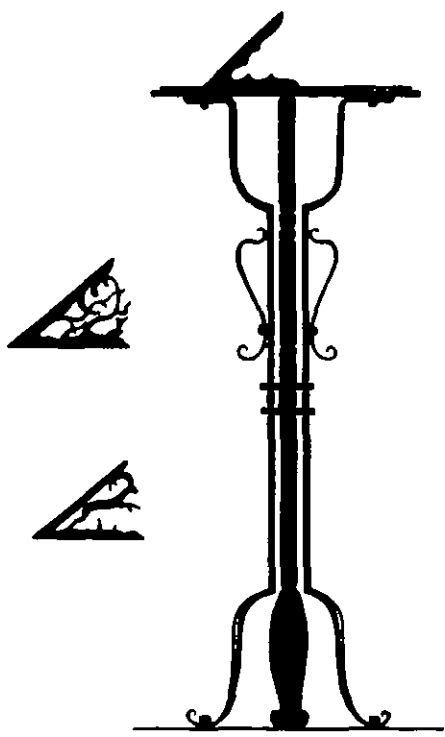

1151

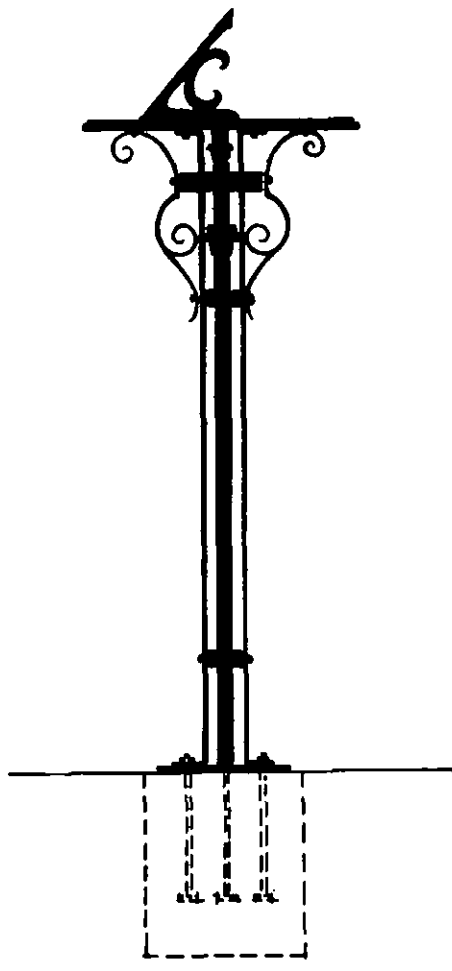

1152

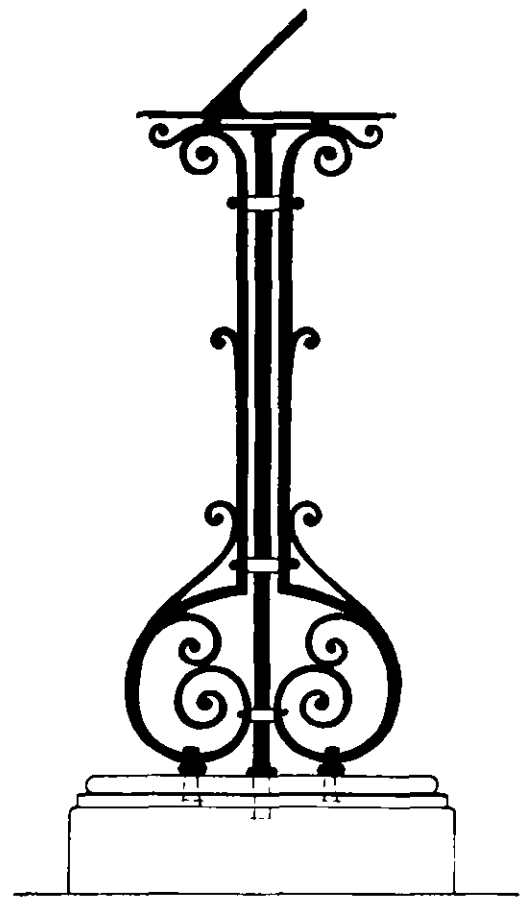

1153

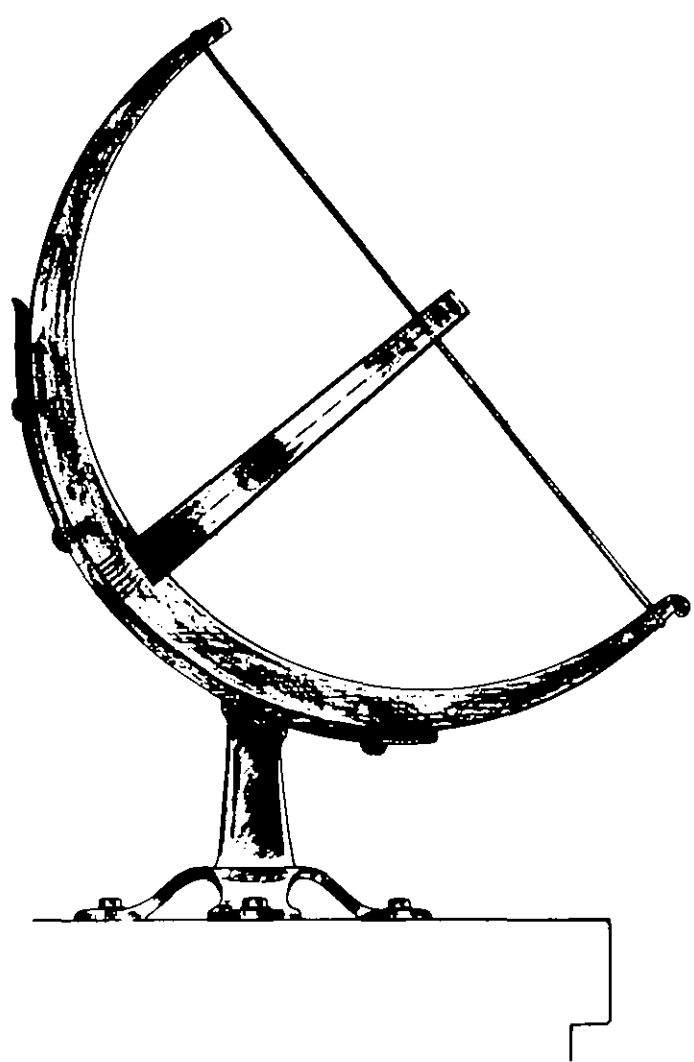

1155

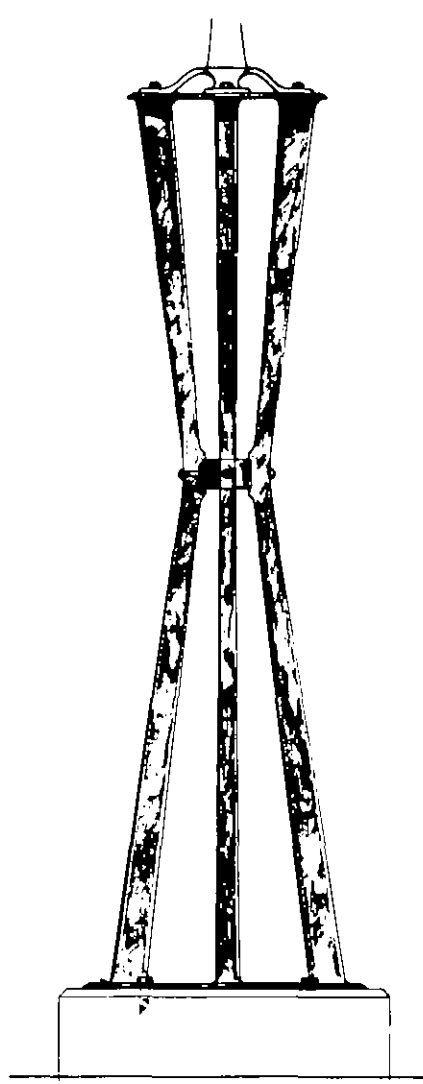

1154

Balustrades and Railings

1250	as required
1251	3'4"
1252	3'5"
1253	2'6"
1254	3'6"
1255	3'0"
1256	} 3'2"
1257	
1258	
1259	5'11" x 3'0"
1260	2'6"
1261	2'5"
1262	2'7"
1263	3'6"
1264/1	} 2'9"
1264/2	
1264/3	
1265/1	} 2'9"
1265/2	
1266	2'8"
1267	2'8"
1268	2'8"
1269	2'7"
1270	4'0" x 3'9"
1271	3'0"
1272	11'0" x 3'6"
1273	2' x 2' sheet
1274	3' high
1275	2'5" x 2'6" sheet
1276	1'3" x 1'7" sheet

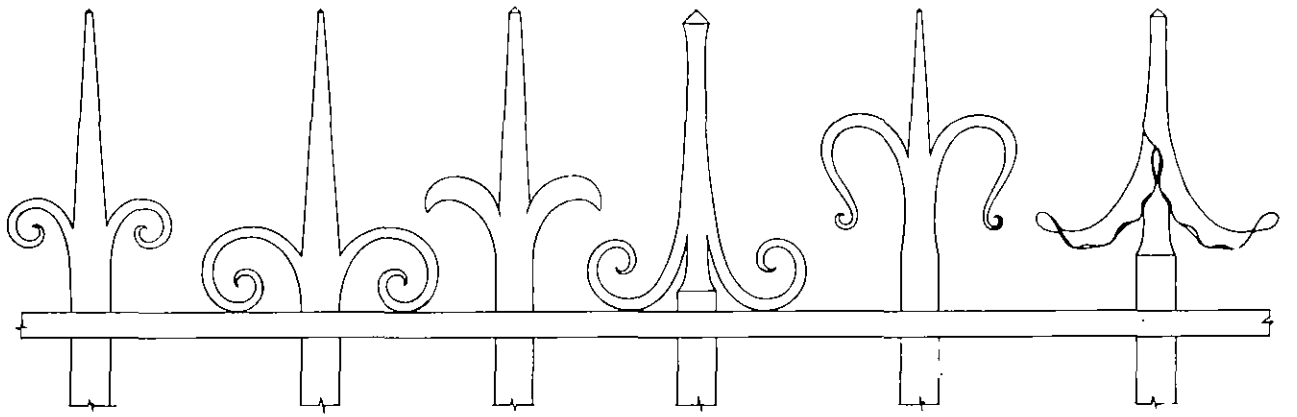
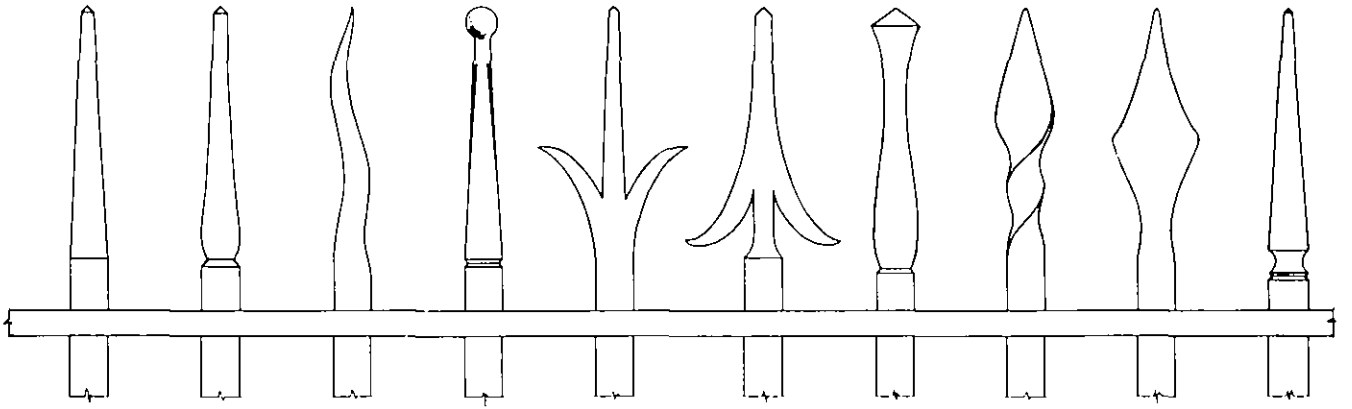

1250

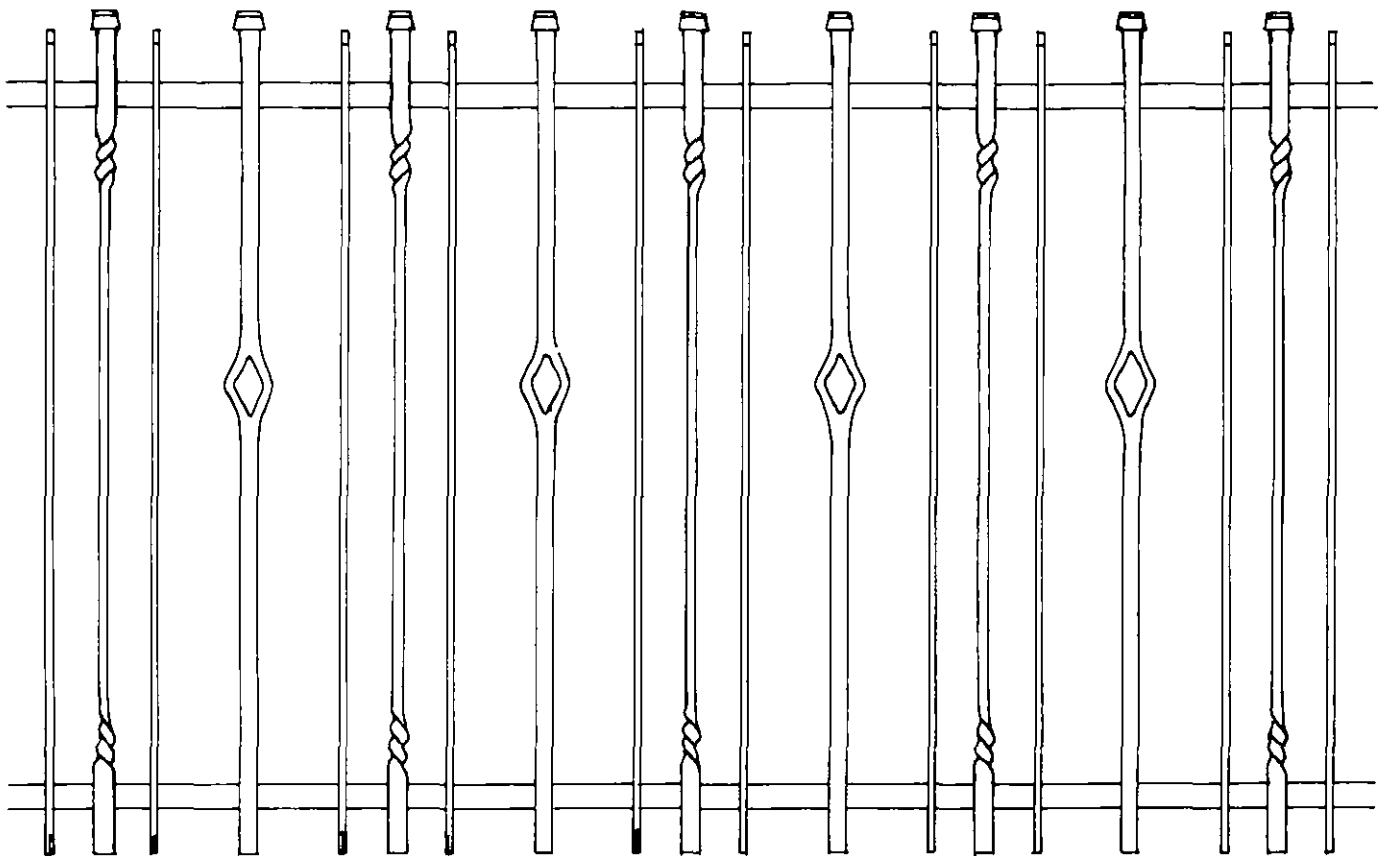

1251

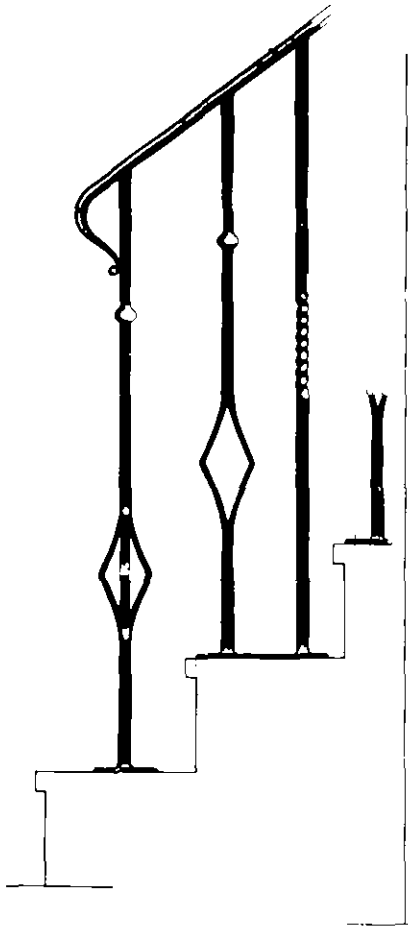

1252

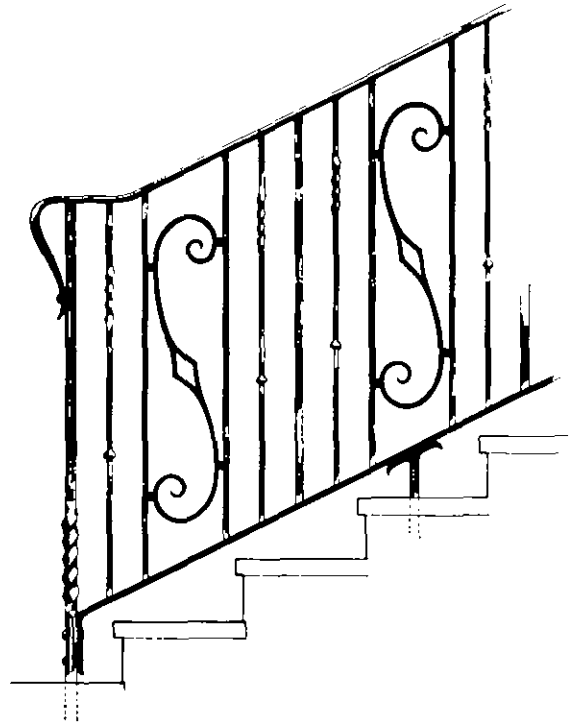

1254

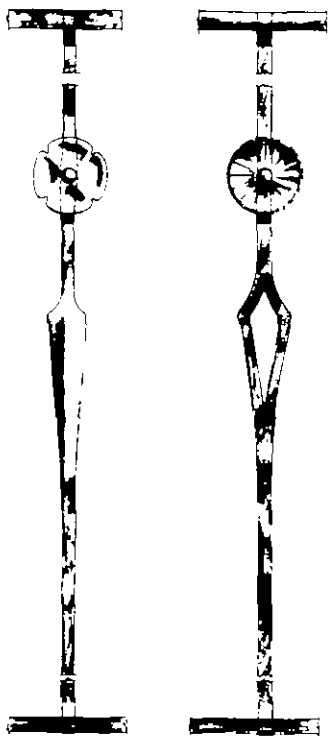

1253

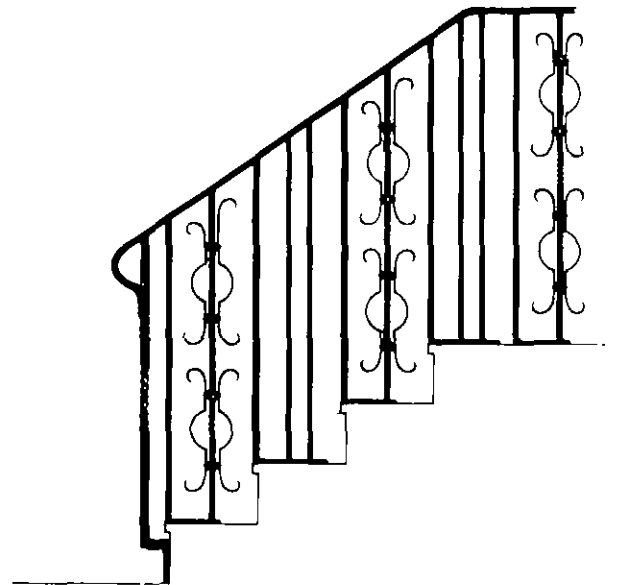

1255

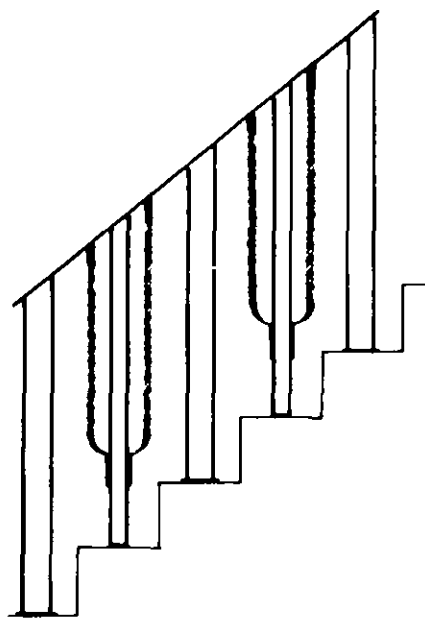

1256

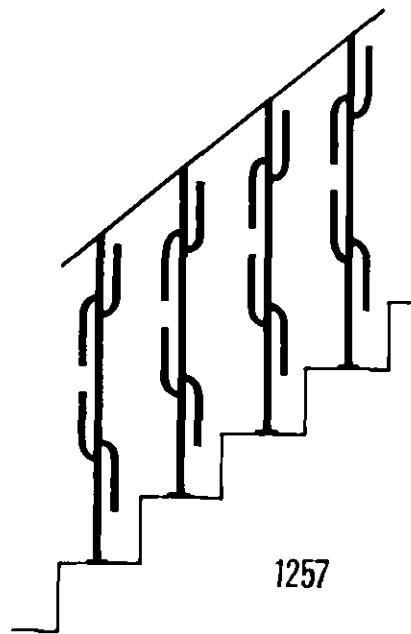

1257

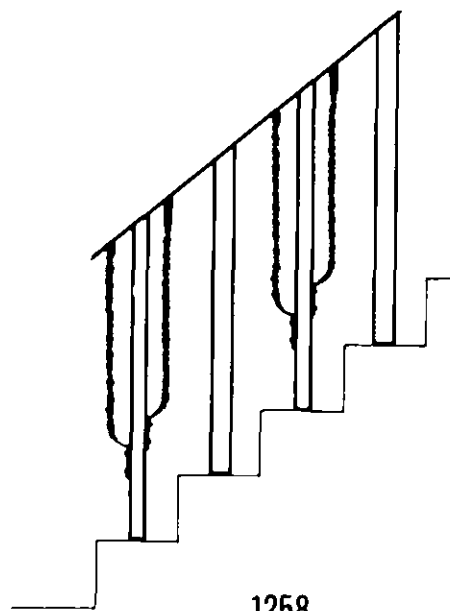

1258

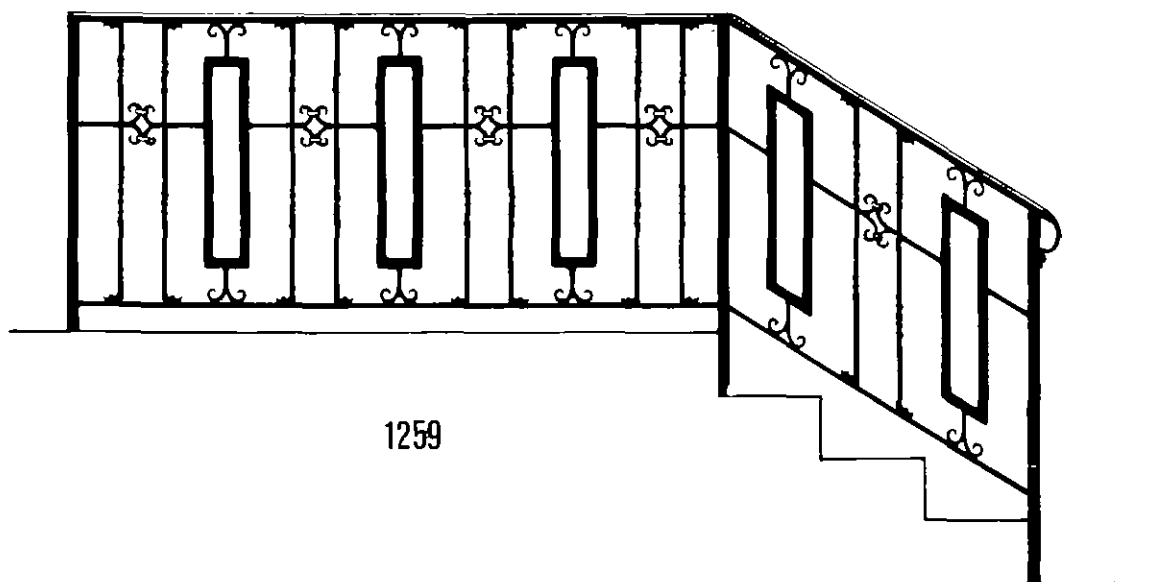

1259

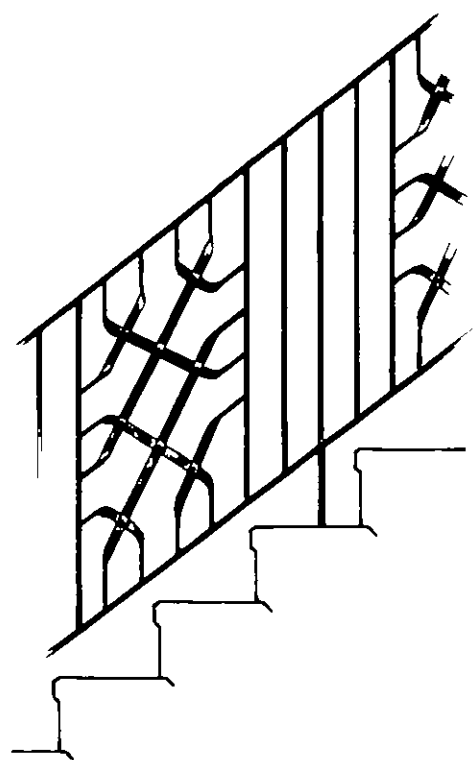

1260

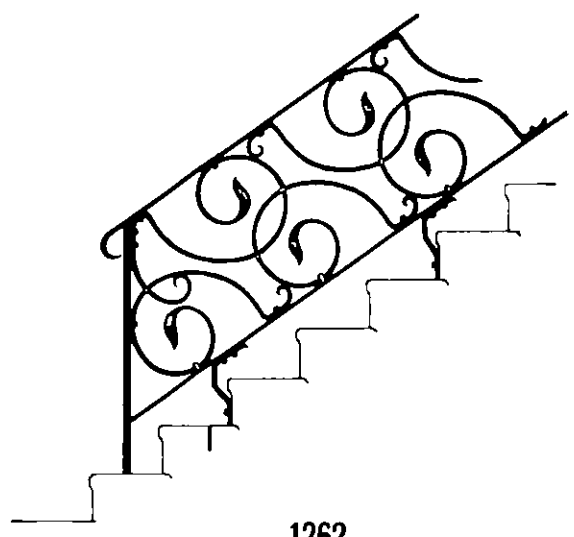

1262

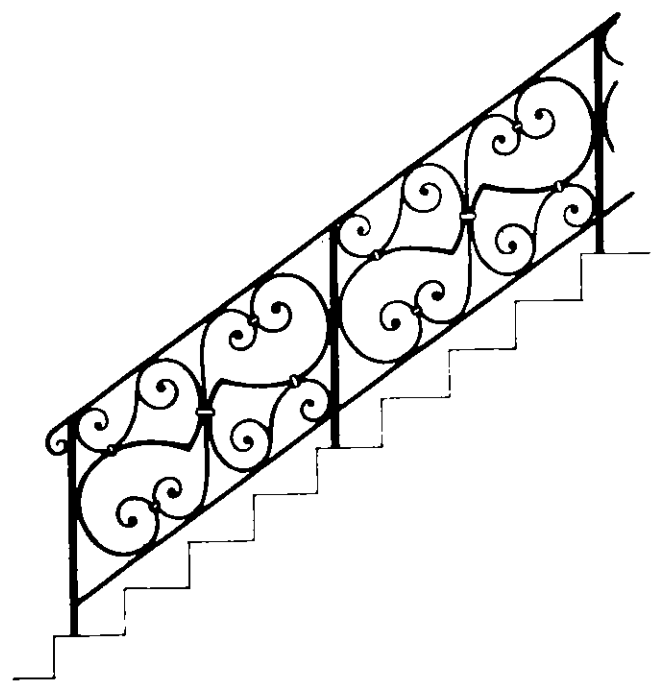

1261

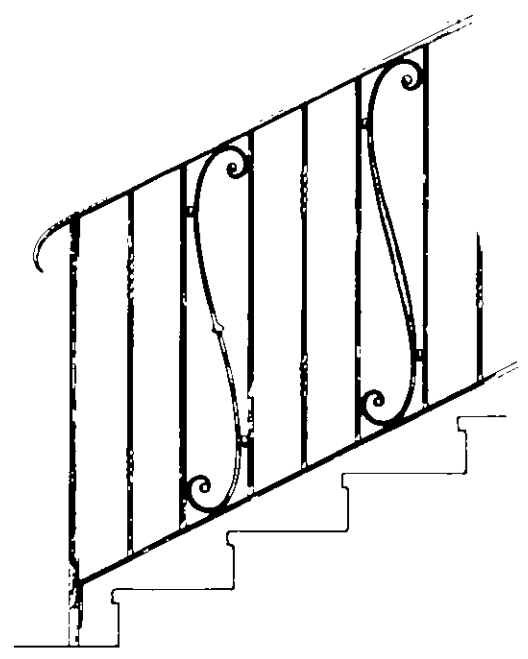

1263

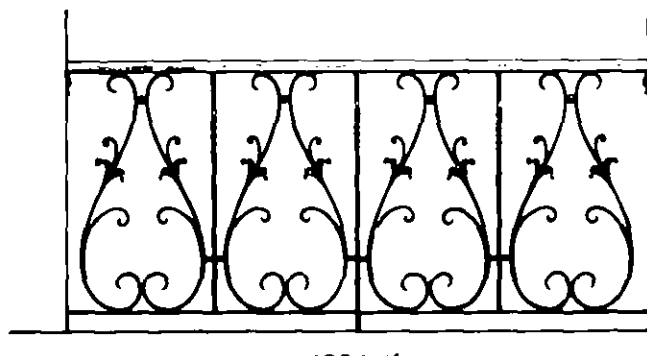

1264/1

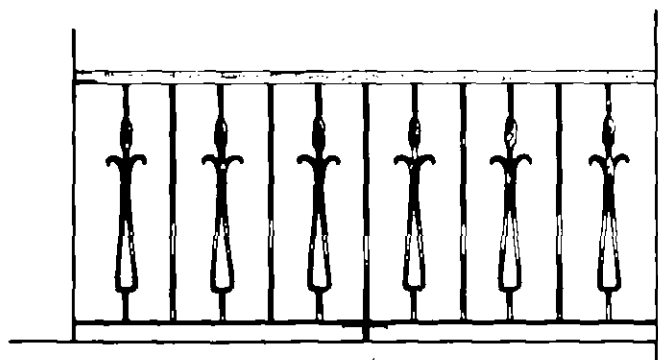

1264/2

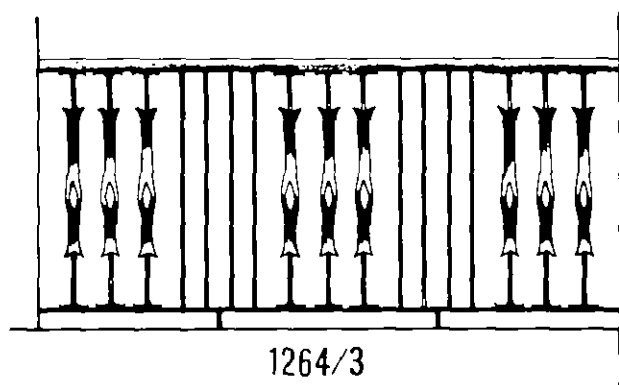

1264/3

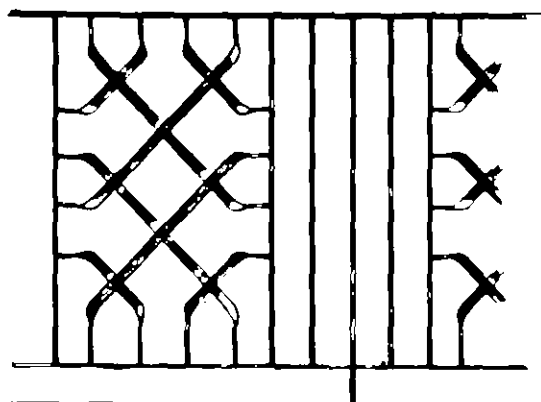

1265/1

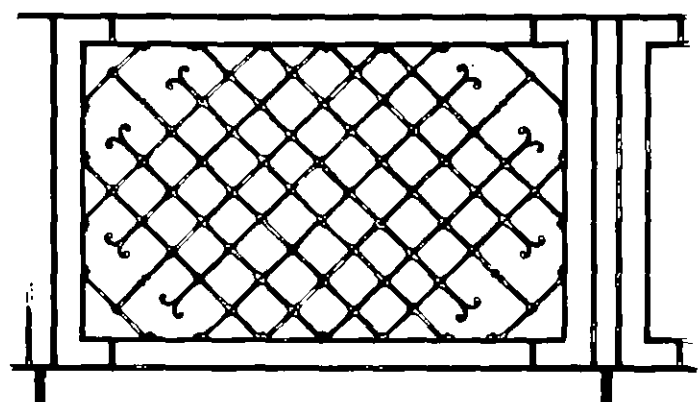

1265/2

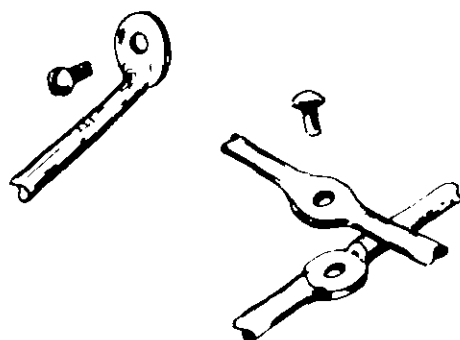
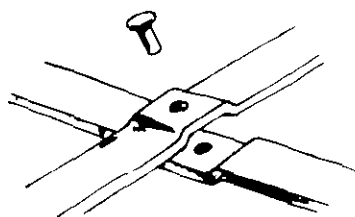

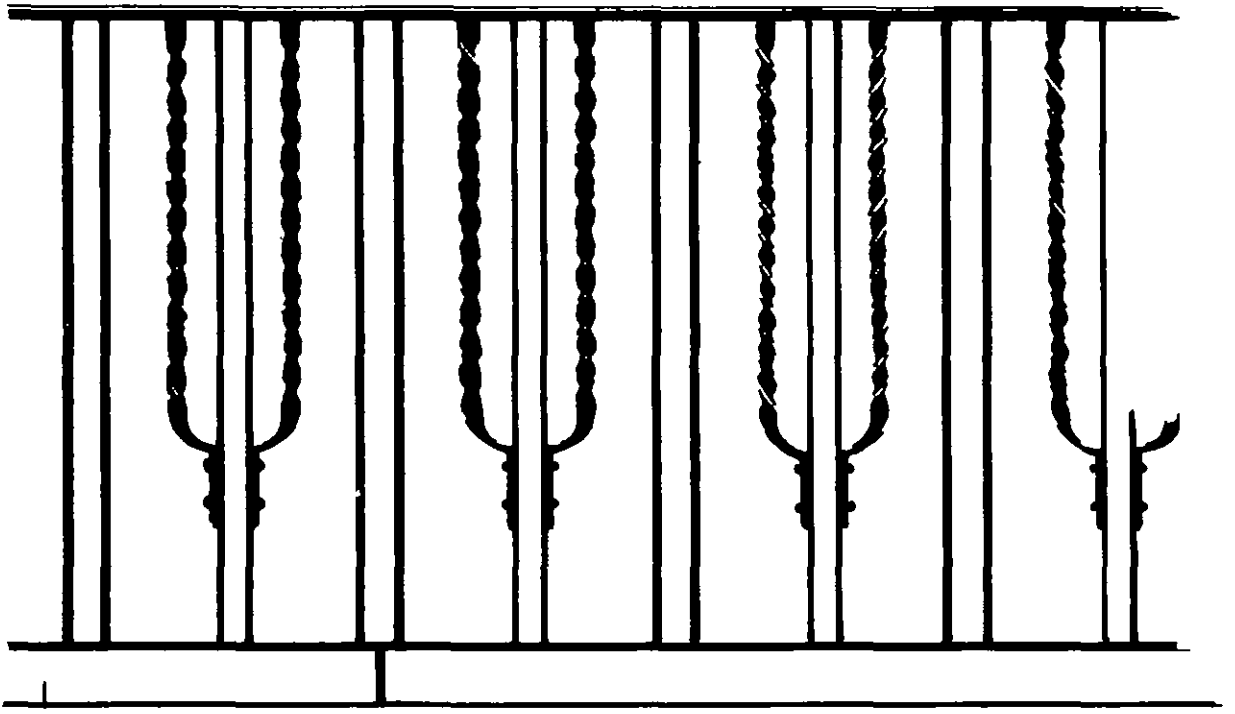

1266

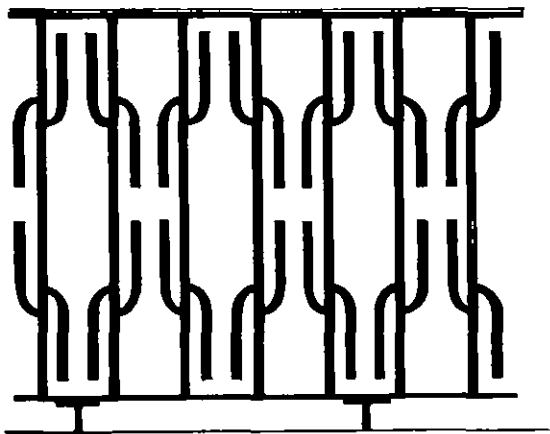

1267

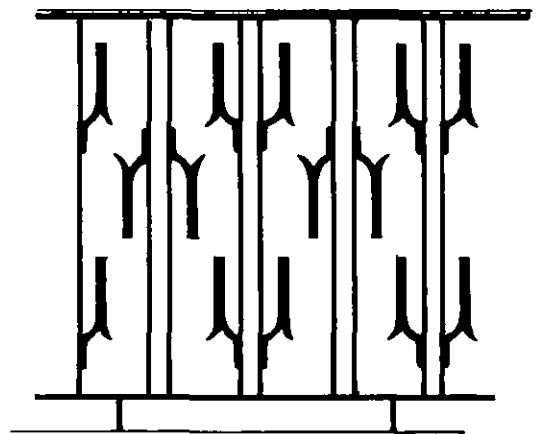

1268

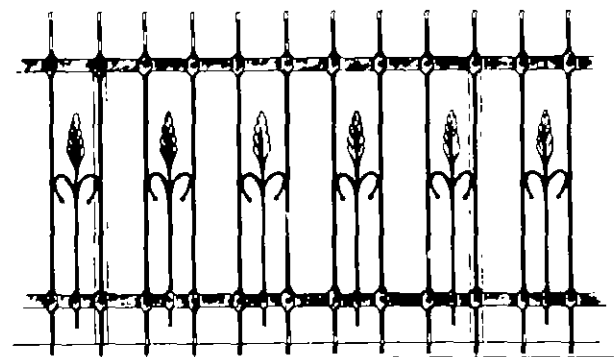

1270

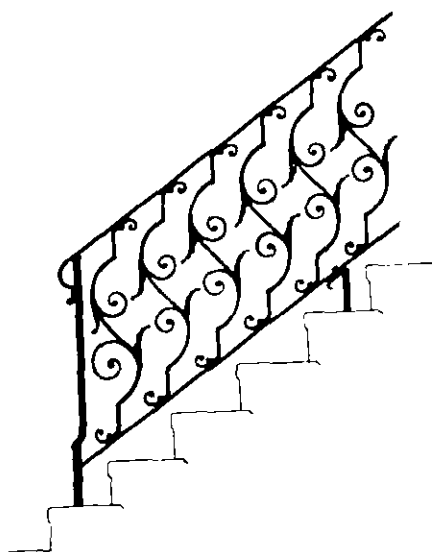

1269

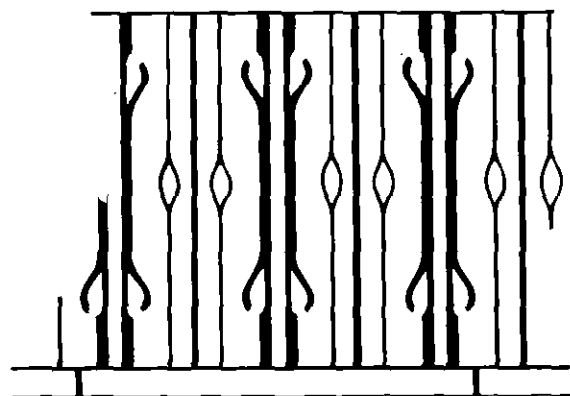

1271

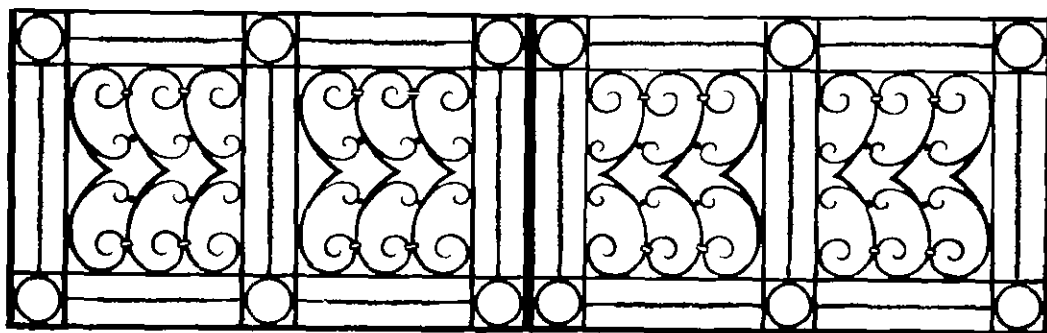

1272

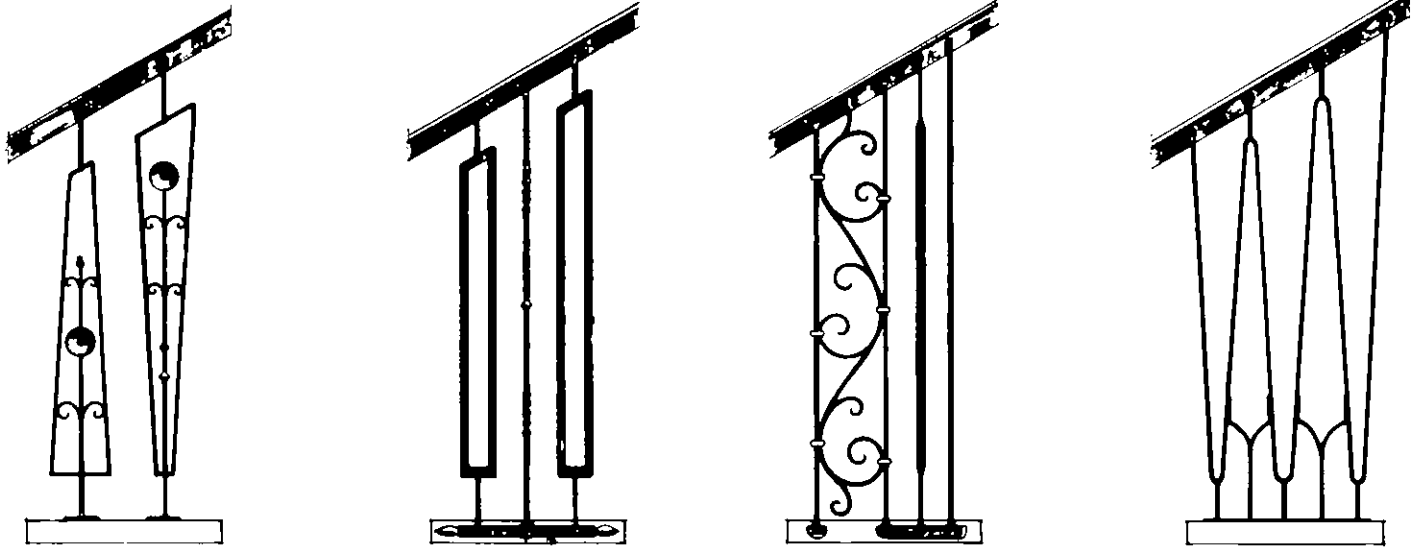

1273

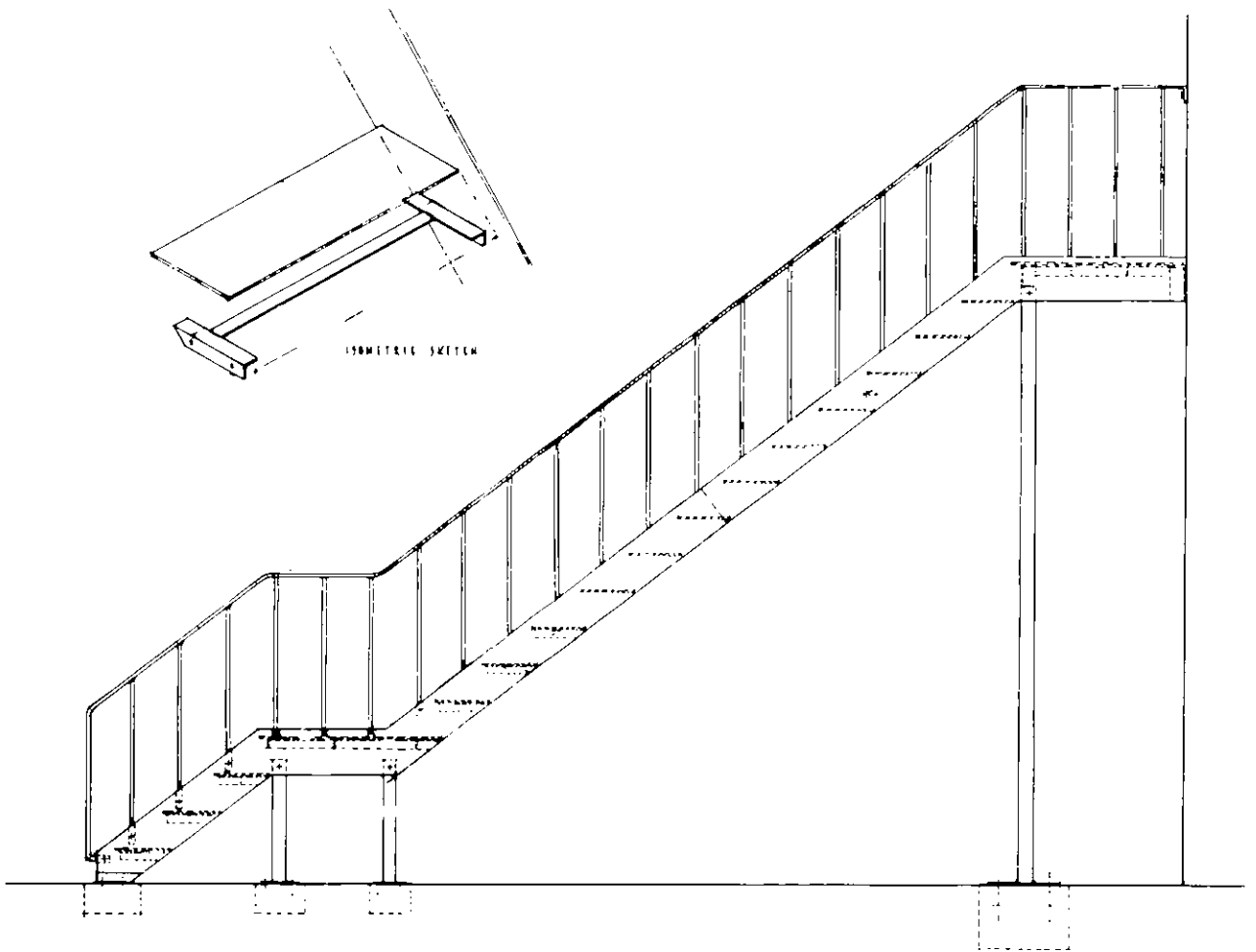

1274

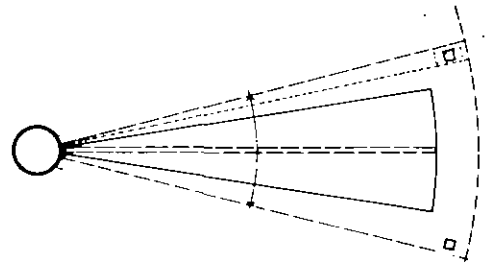
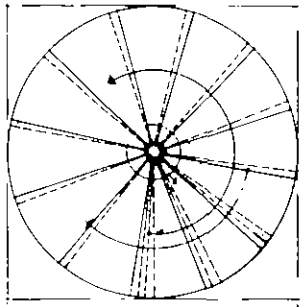
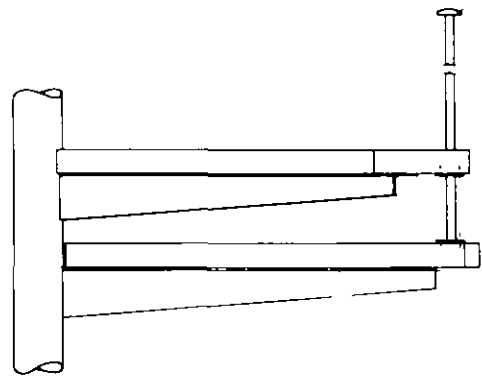
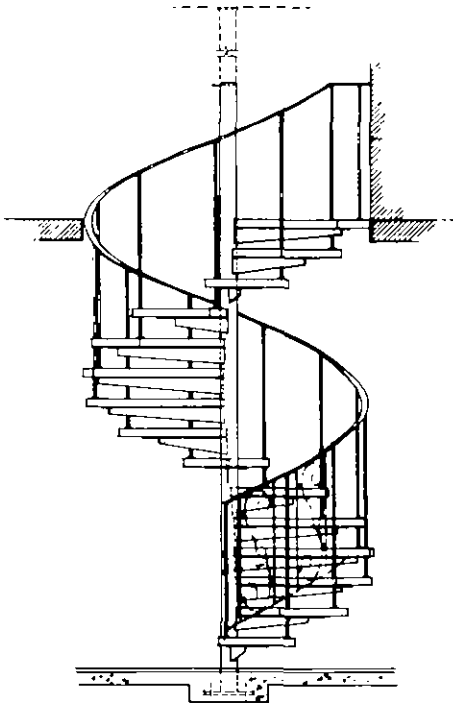

1275

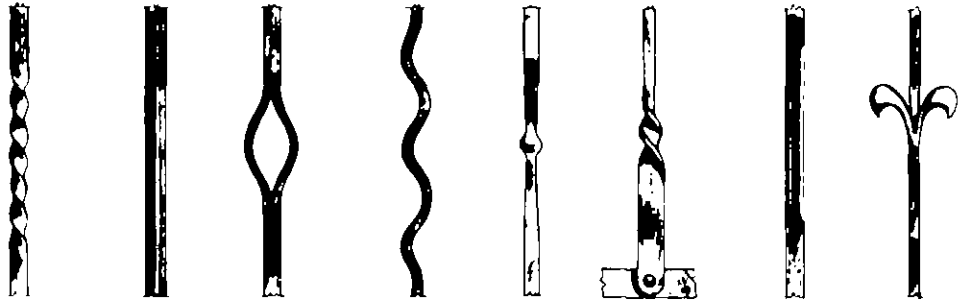

Miscellaneous

- 1375 6" x 6"
- 1376 5" x 3"
- 1377 8" x 6"
- 1378 1'6" x 11½"
- 1379 10½" x 7"
- 1380 4" dia.
- 1381 8"
- 1382 1'1"
- 1383 7½"
- 1384 1'0"
- 1385 1'0"
- 1386 as required
- 1387 1'7"
- 1388 2'0" & 3'0"
- 1389 6" & 3" dia.
- 1390 3½"
- 1391 3½"
- 1392 8'0" x 2'3"
- 1393 7'6" x 2'3"
- 1394 3'6" O/A dia.
- 1395 3'11" x 3'0"
- 1396 5'4" x 2'8"
- 1397 { 4'3" dia
5' high
- 1398 8⅜" x 6"
- 1399 1'11" long
- 1400 2'10" high

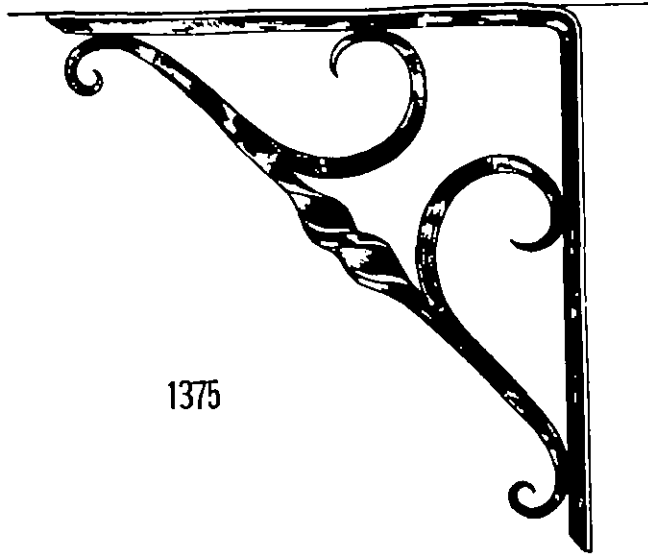

1375

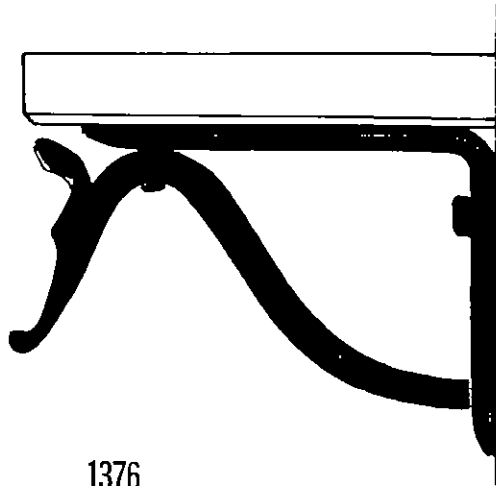

1376

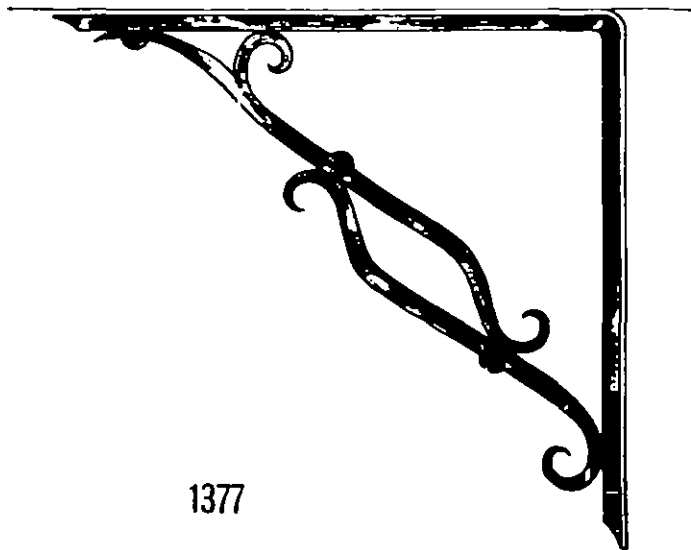

1377



1378

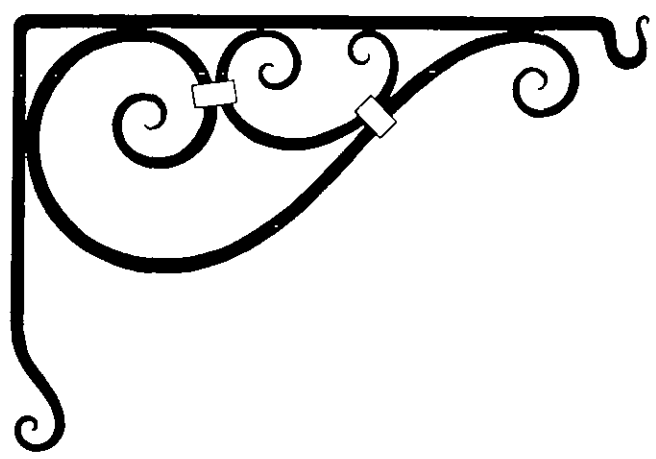

1379

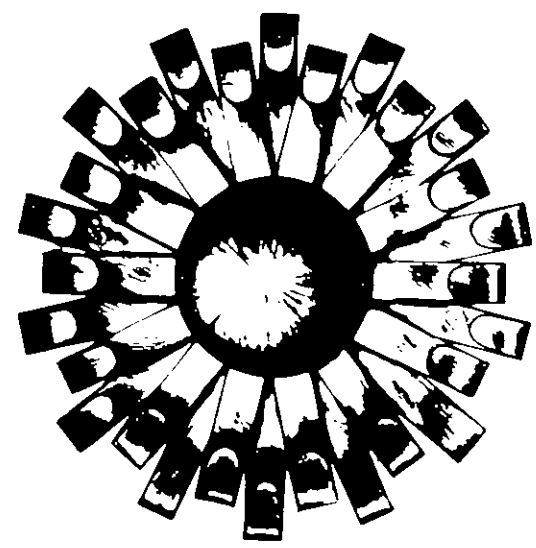

1380

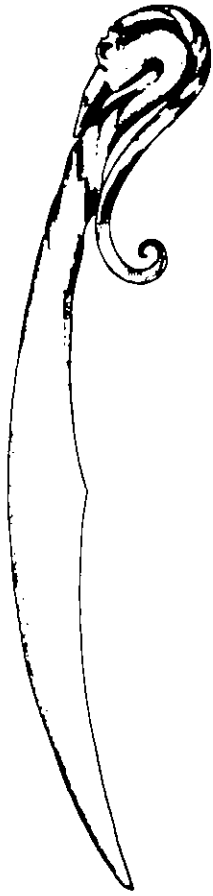

1381



1383

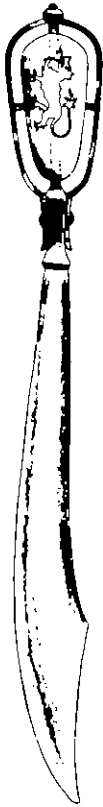

1382



1384



1385

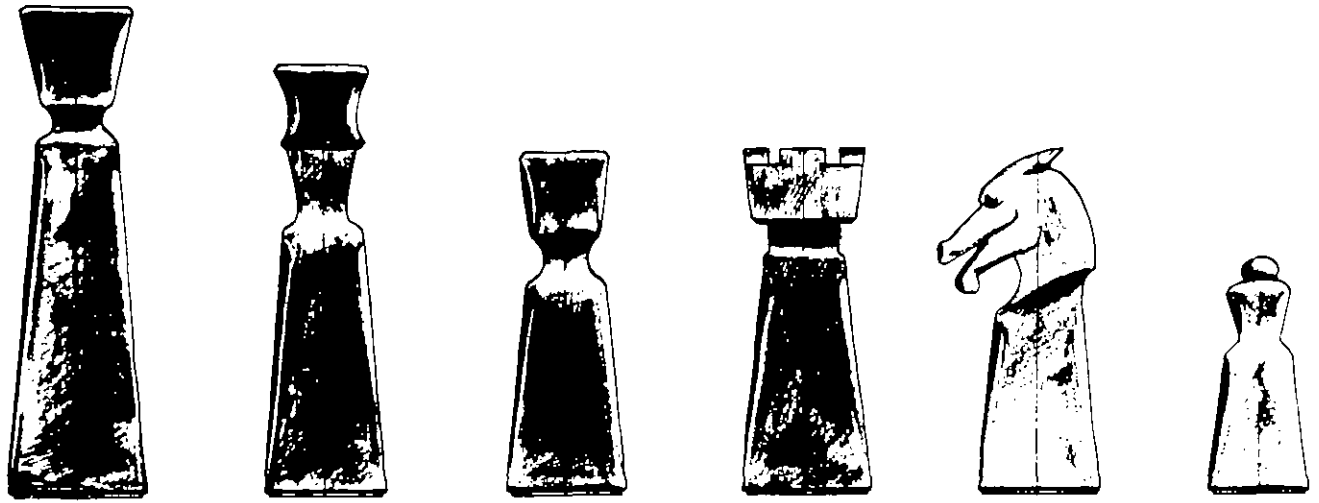

1386

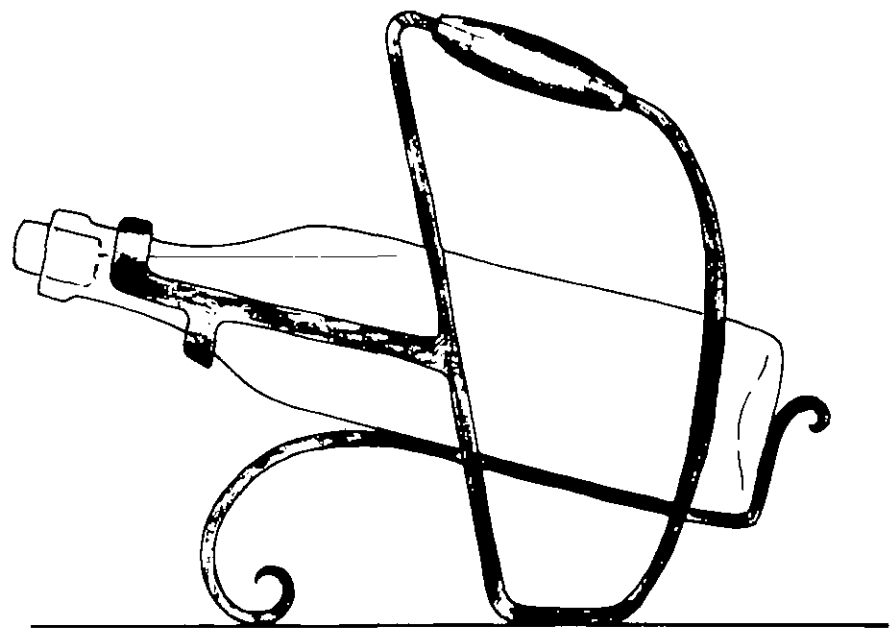

1387

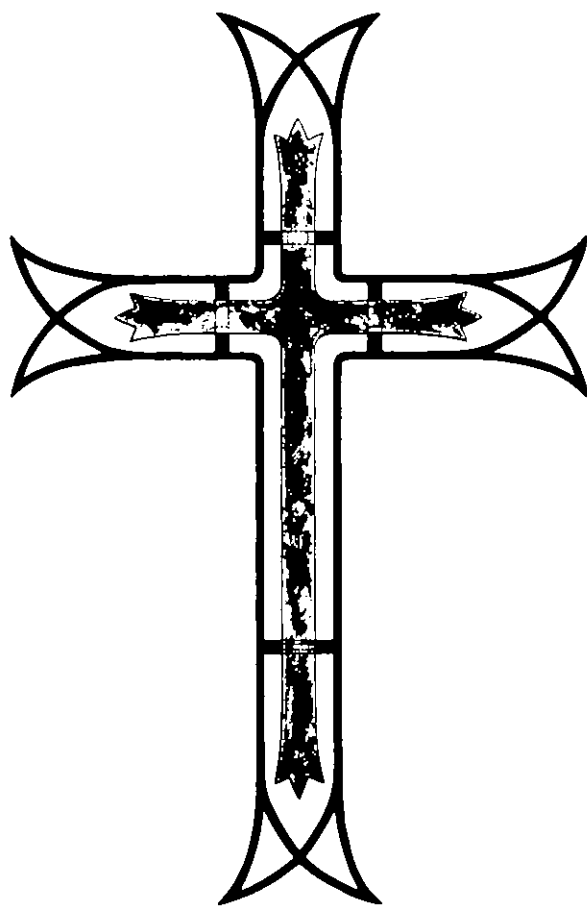

1388

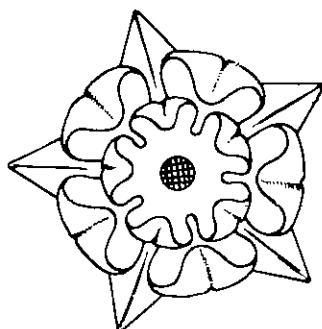
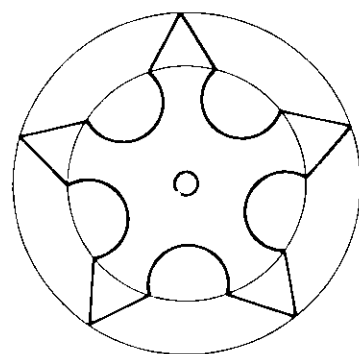
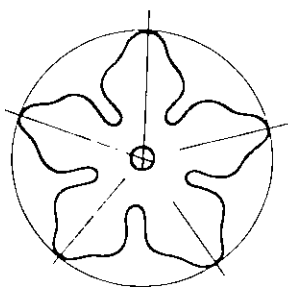
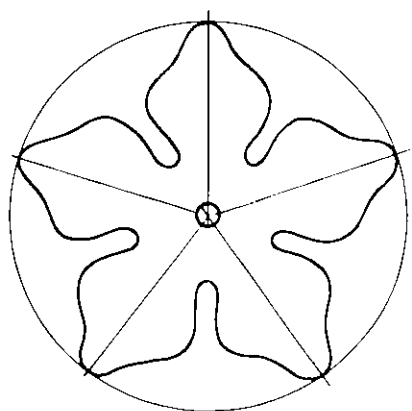

1389

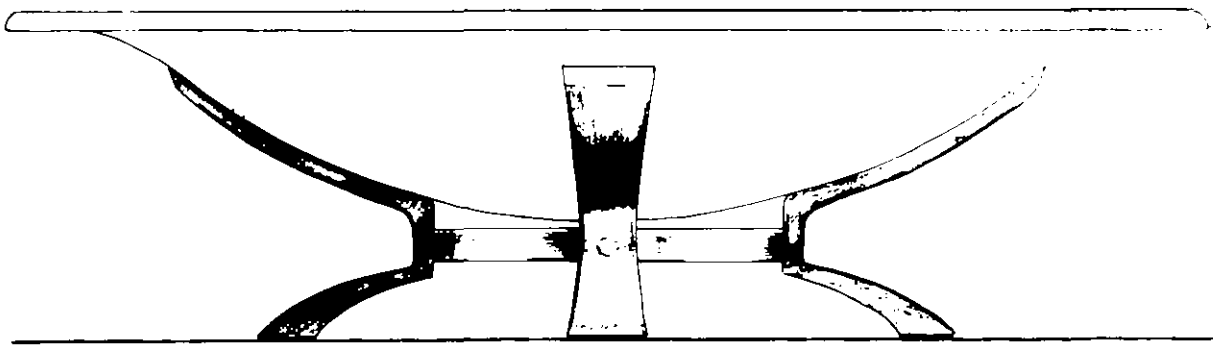

1390

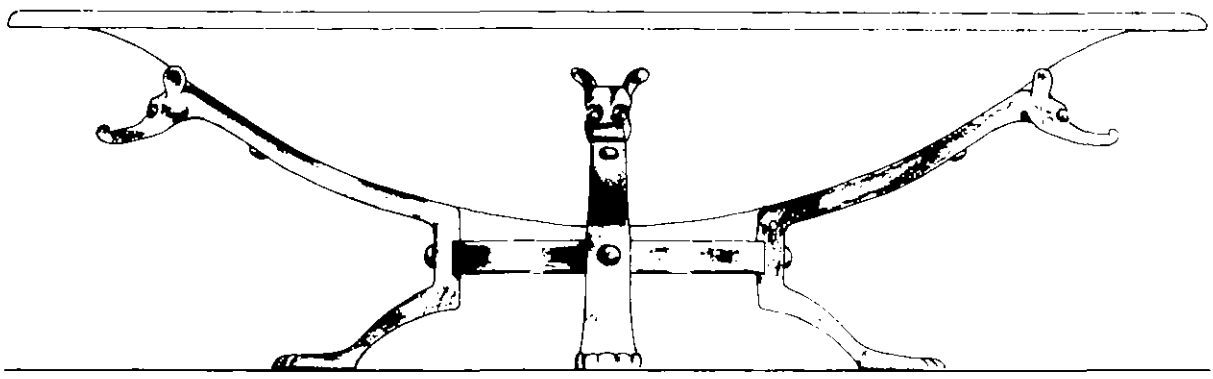

1391

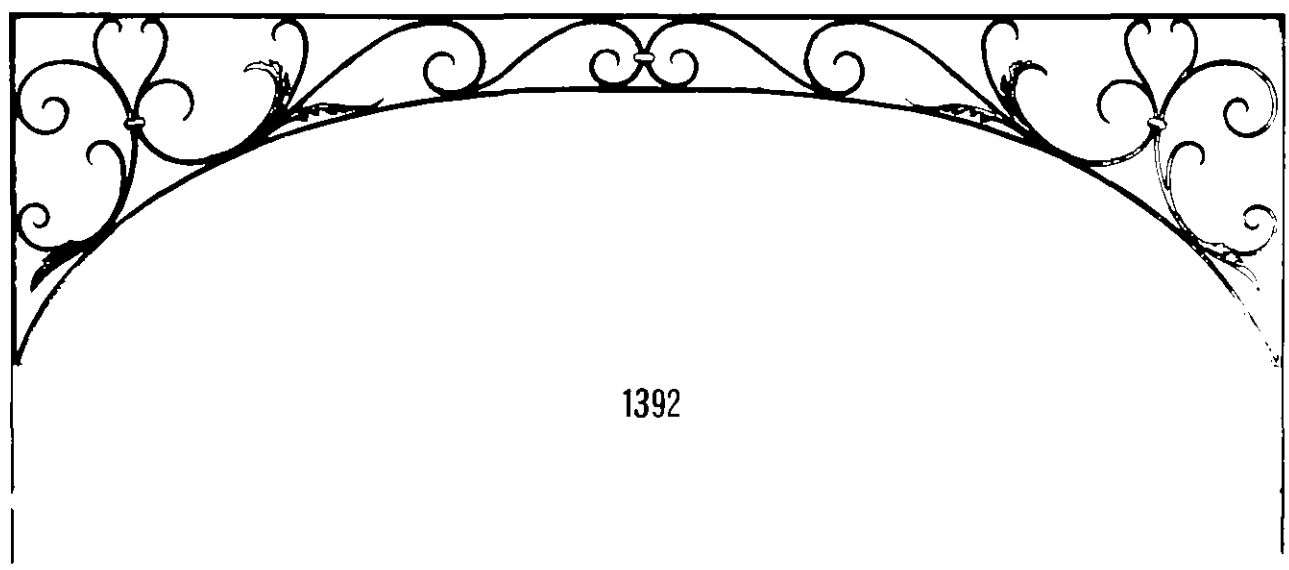

1392

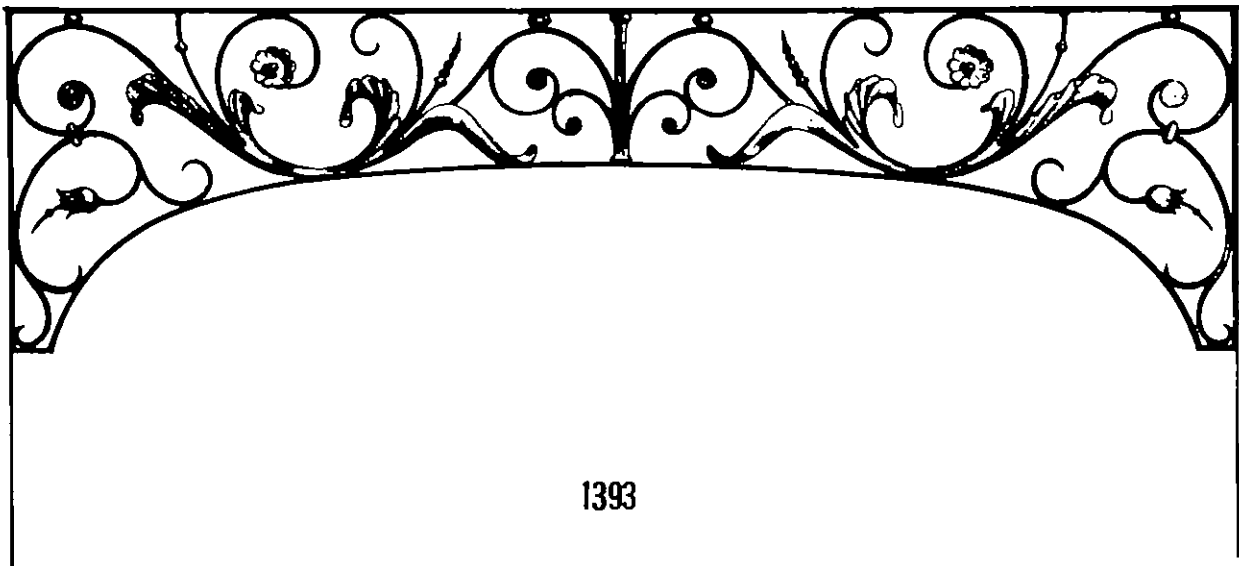

1393

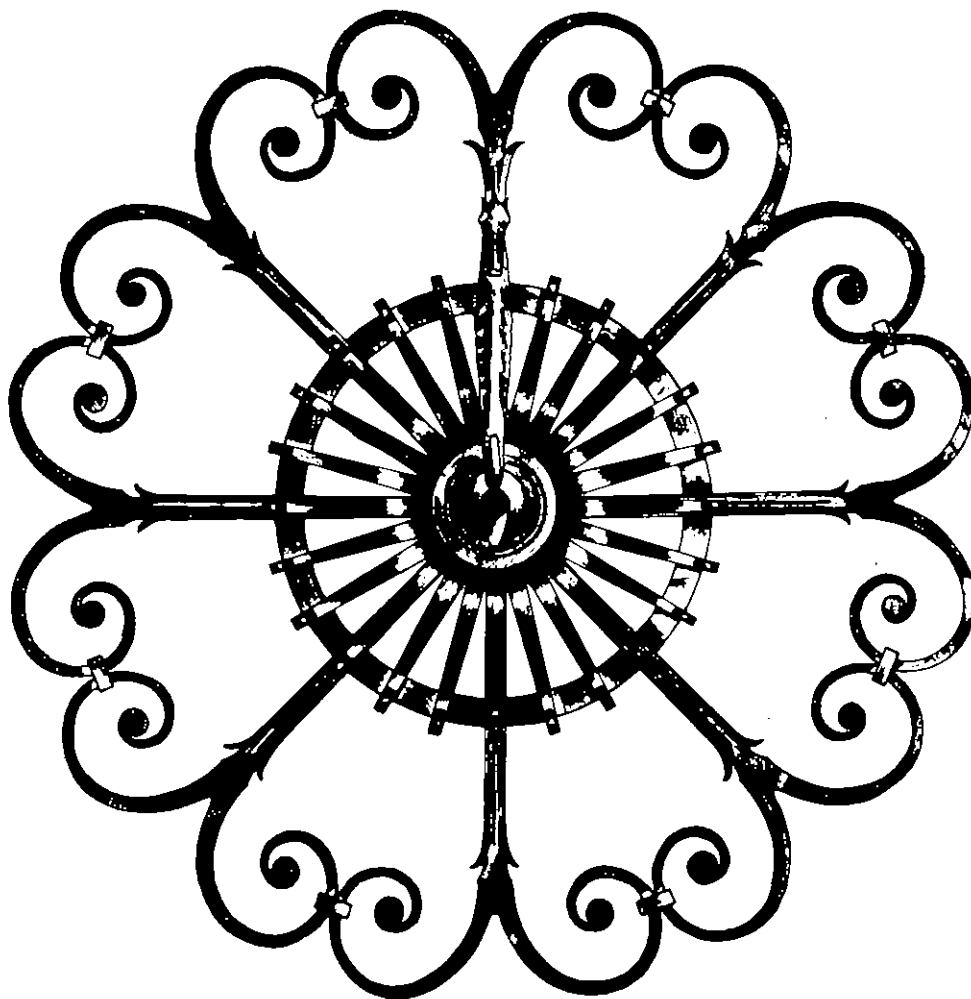

1394

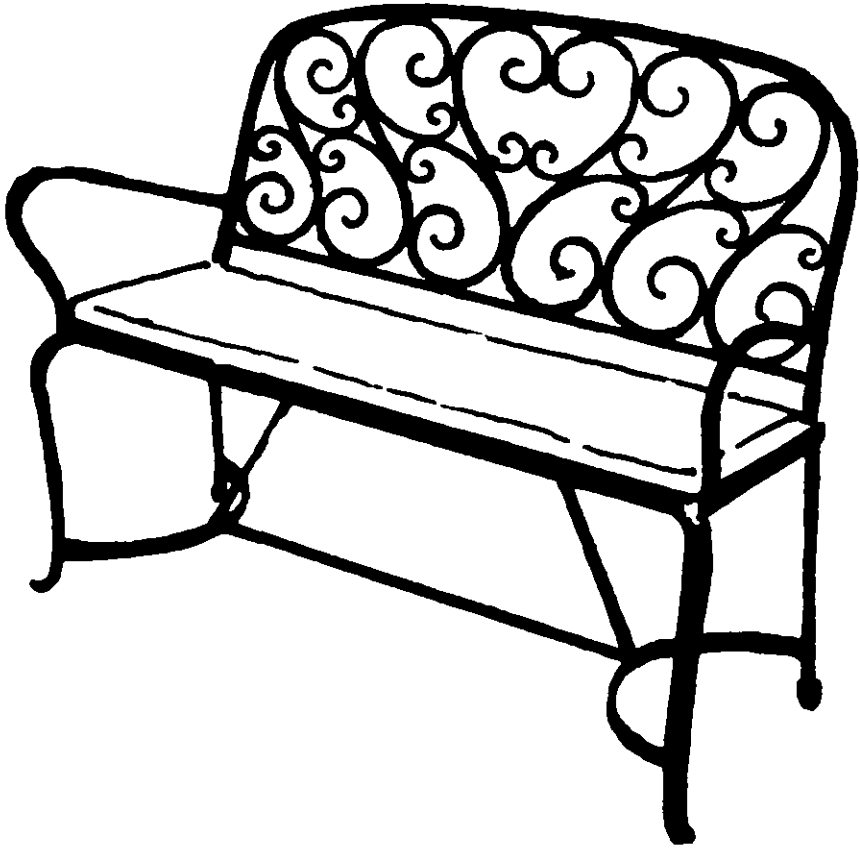

1395

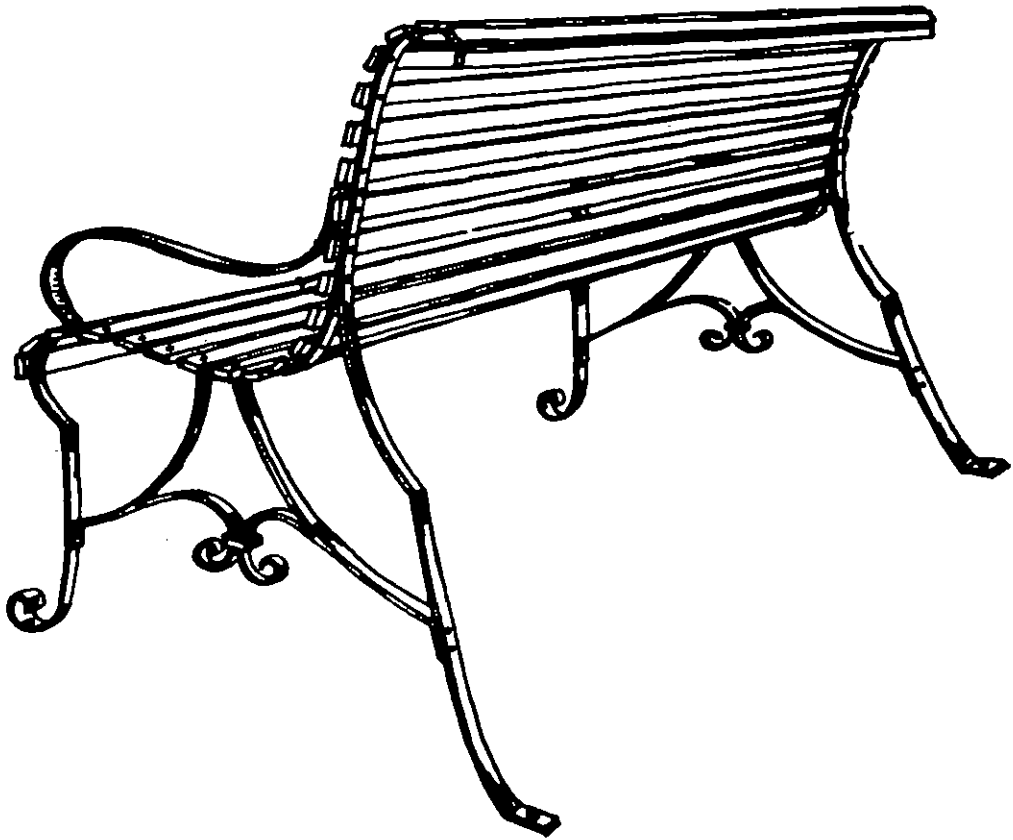

1396

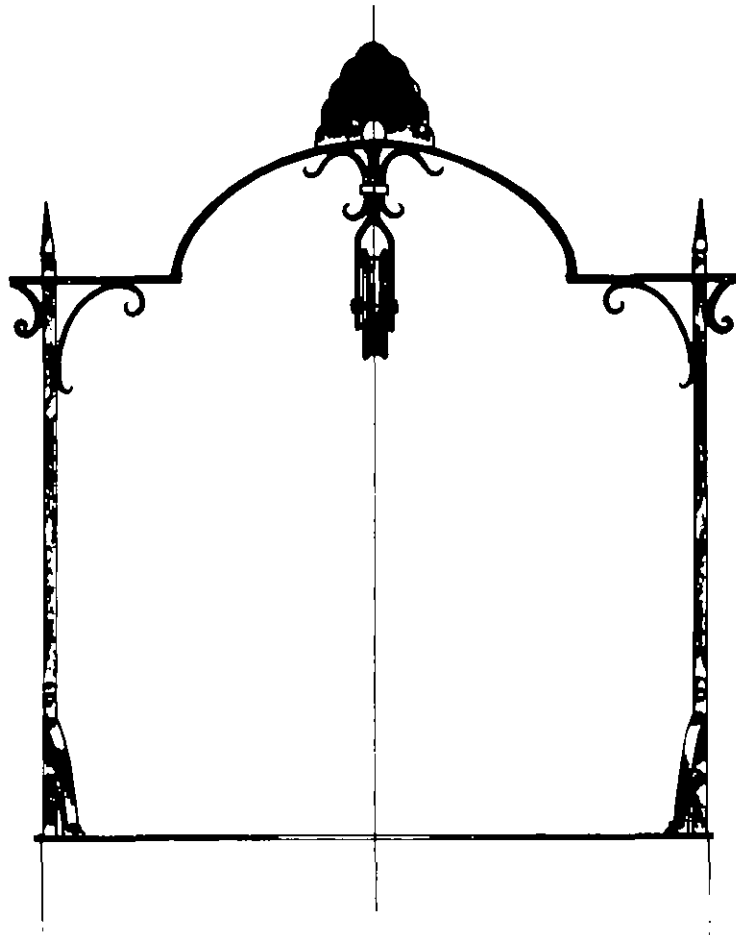

1397

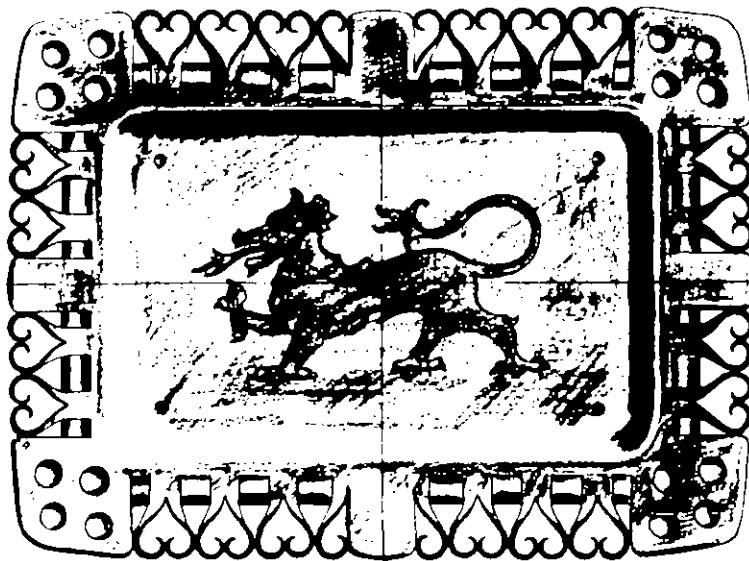

1398

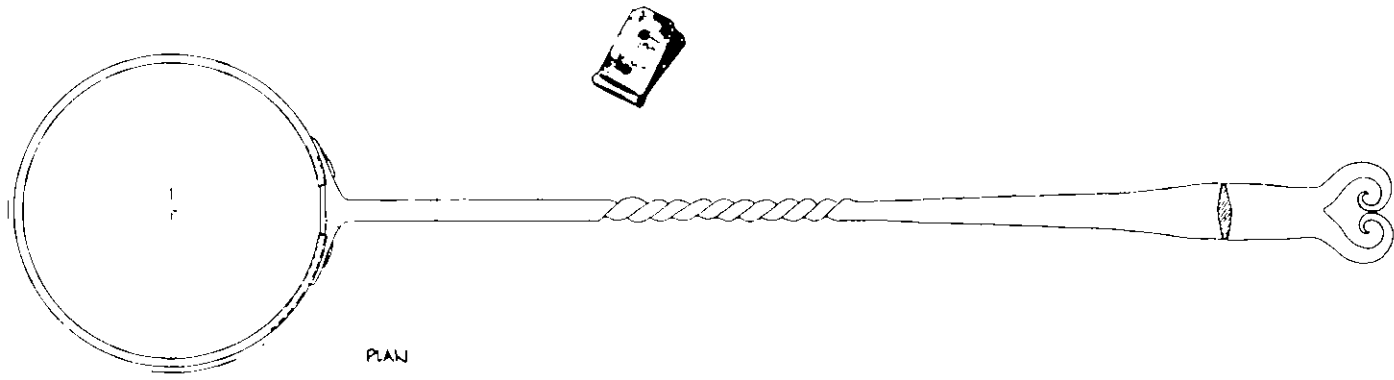
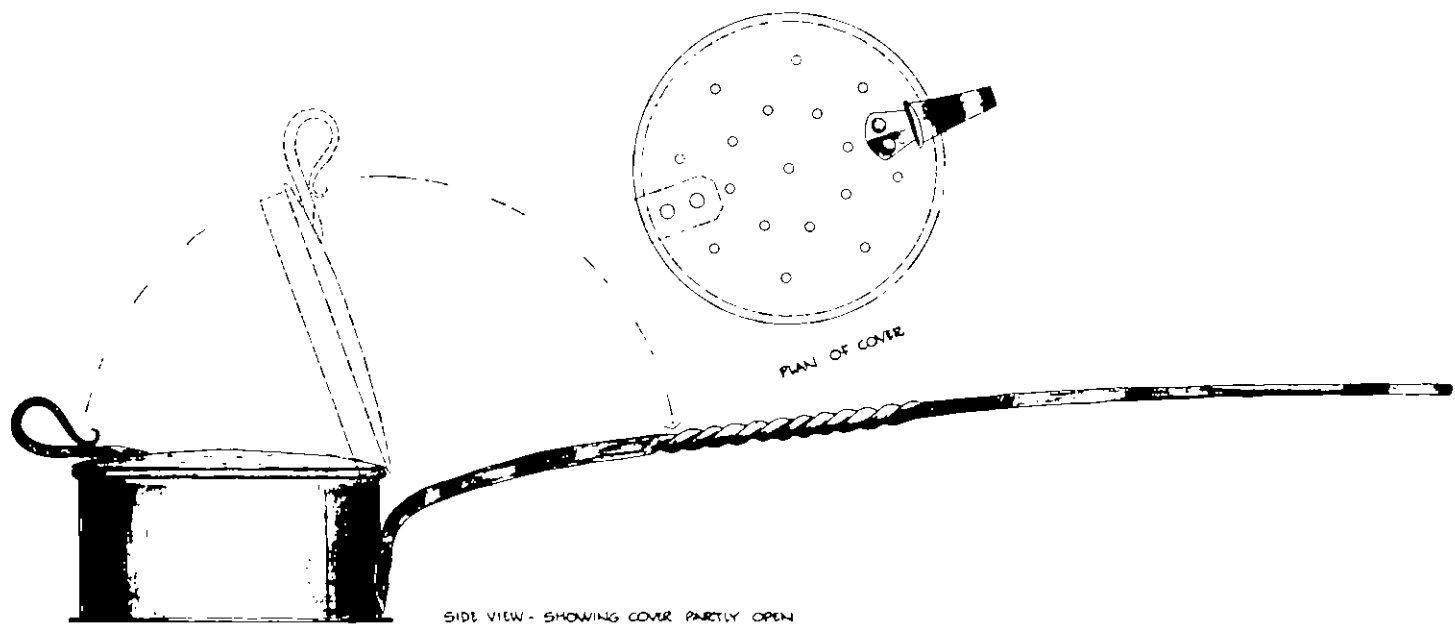

1399

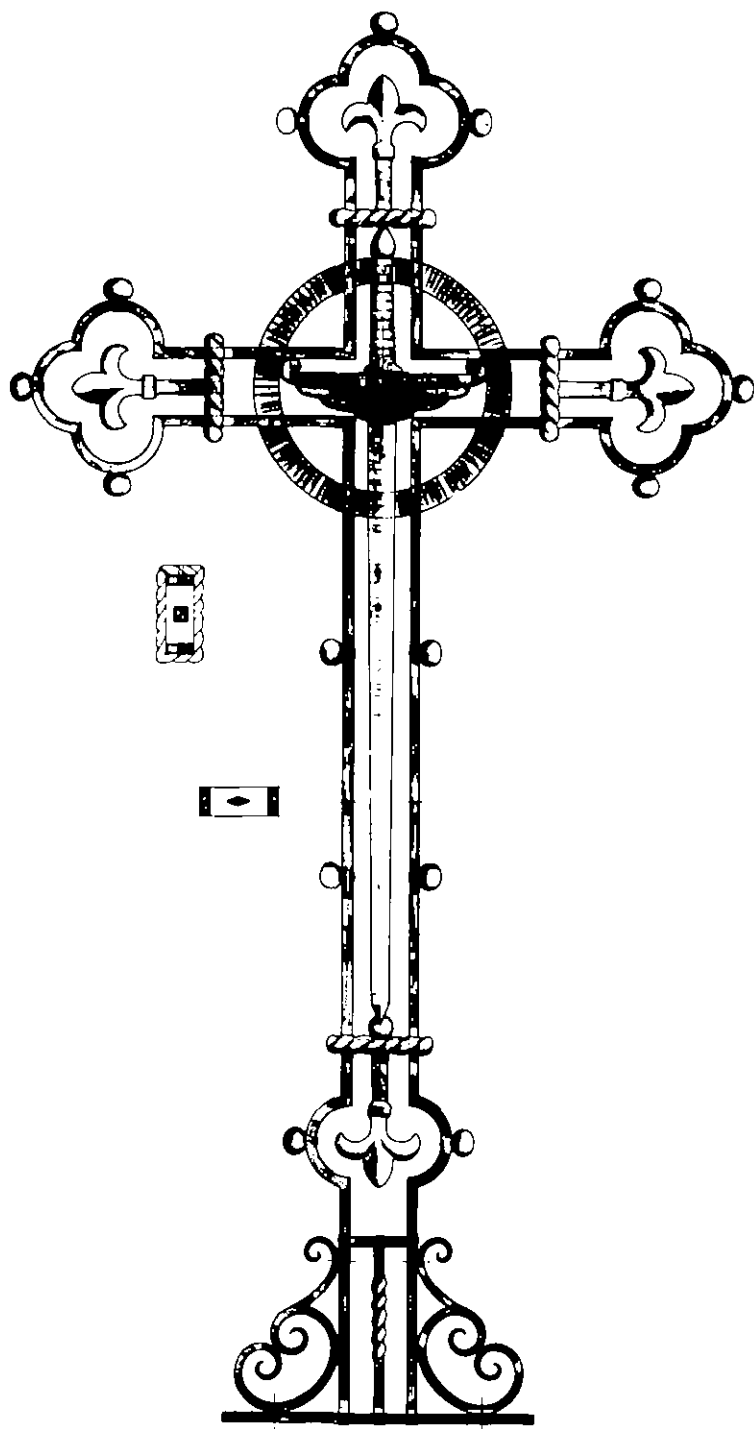

1400

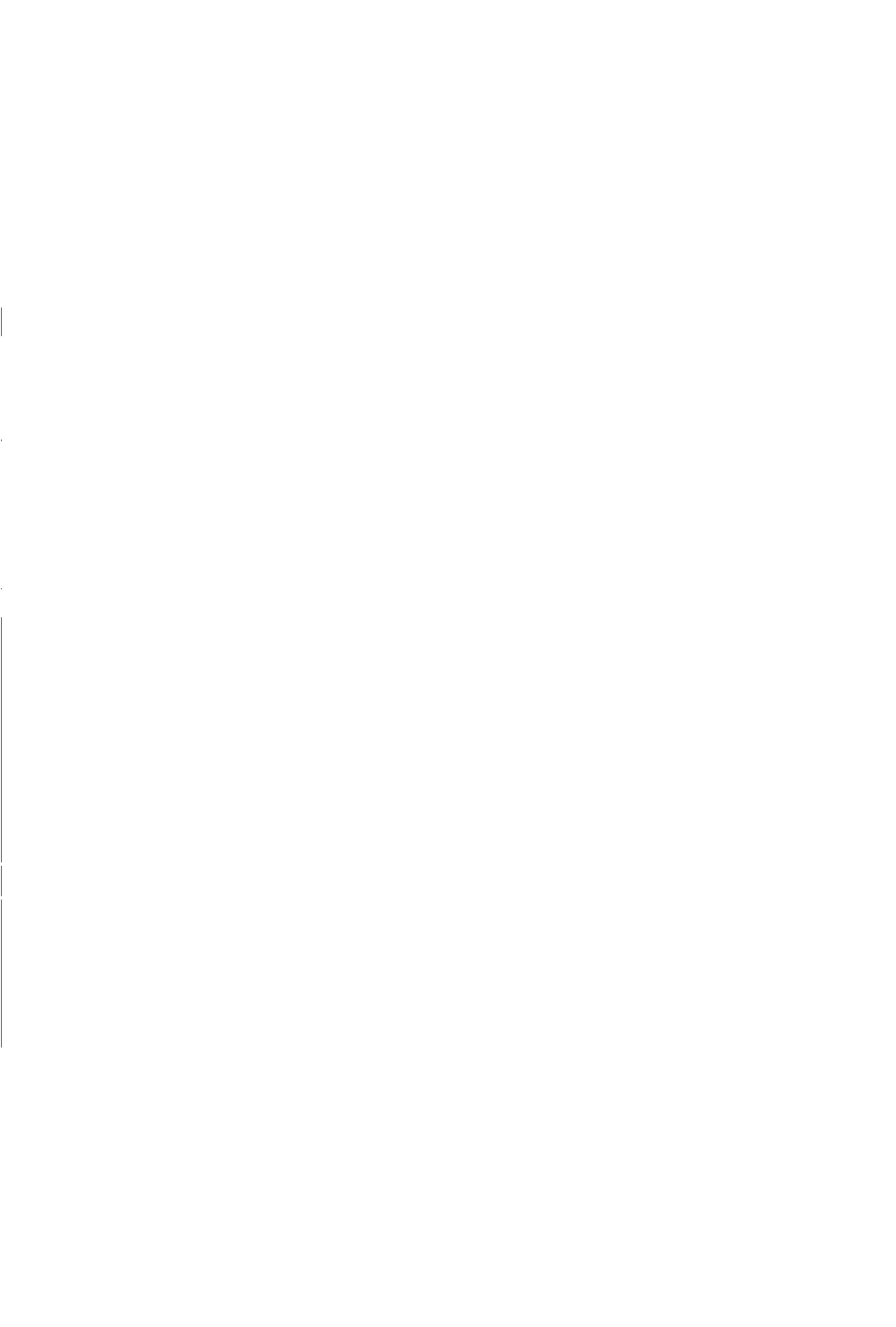

Gates

1500	3'6" x 4'3"	1546	11'6" x 6'0"	1591	9'0" x 4'5"
1501	4'10" x 6'0"	1547	10'10" x 10'10"	1592	8'0" x 4'6"
1502	3'6" x 5'0"	1548	8'4" x 10'9"	1593	6'7 $\frac{3}{8}$ " x 16'0"
1503	3'0" x 4'0"	1549	11'6" x 10'10"	1594	12'0" x 6'9"
1504	4'7 $\frac{3}{8}$ " x 2'10"	1550	11'6" x 10'10"	1595	5'0" x 4'3"
1505	6'4" x 3'9"	1551	10'3" x 7'2"	1596	12'0" x 5'0"
1506	3'10" x 6'3"	1552	12'0" x 6'7"	1597	12'10" x 5'0"
1507	3'6" x 4'6"	1553	4'0" x 4'0"	1598	9'0" x 4'0"
1508	6'0" x 3'9"	1554	20'0" x 6'6"	1599	8'0" x 3'6 $\frac{1}{2}$ "
1509	7'9" x 6'6"	1555	12'0" x 5'8"	1600	5'0" x 2'6"
1510	5'0" x 2'9"	1556	14'0" x 3'6"	1601	13' x 10'
1511	5'11" x 3'9"	1557	13'3" x 7'3"	1602	6'4" x 6'8"
1512	5'0" x 2'9"	1558	9'0" x 3'6"	1603	6'1 $\frac{1}{2}$ " x 5'3"
1513	3'0" x 6'3"	1559	9'0" x 4'6"	1604	12' x 9'9"
1514	3'0" x 3'10"	1560	6'0 $\frac{3}{4}$ " x 4'11 $\frac{1}{2}$ "	1605	12' x 4'6"
1515	3'0" x 3'10"	1561	6'0" x 8'0"		
1516	6'6 $\frac{1}{2}$ " x 3'3"	1562	12'0" x 8'9"		
1517	7'10" x 3'0"	1563	11'0" x 8'4"		
1518	7'8 $\frac{1}{2}$ " x 6'7"	1564	12'0" x 7'0"		
1519	3'2" x 4'0"	1565	8'4 $\frac{1}{2}$ " x 4'0"		
1520	3'3 $\frac{1}{2}$ " x 2'10"	1566	11'2" x 5'8"		
1521	4'8 $\frac{1}{2}$ " x 4'3"	1567	8'0" x 3'2"		
1522	3'9" x 3'7"	1568	{ 10'0" x 11'0" 3'3" x 7'8"		
1523	3'6" x 4'6"	1569	9'0" x 4'7"		
1524	7'6" x 3'6"	1570	13'6" x 5'3"		
1525	7'0" x 3'0"	1571	11'6" x 7'2 $\frac{1}{2}$ "		
1526	7'6" x 3'11"	1572	12'0" x 7'0"		
1527	7'6" x 3'10"	1573	6'6" x 3'3"		
1528	4'0" x 6'5"	1574	8'6" x 5'0"		
1529	4'0" x 7'0"	1575	11'0" x 6'6"		
1530	4'6 $\frac{3}{4}$ " x 8'8"	1576	11'6" x 6'0"		
1531	4'0" x 6'9"	1577	9'0" x 7'0"		
1532	4'0" x 6'9"	1578	8'0" x 4'9"		
1533	3'6" x 7'6"	1579	10'0" x 7'0"		
1534	5'4 $\frac{1}{2}$ " x 3'0"	1580	10'0" x 7'0"		
1535	4'7 $\frac{1}{2}$ " x 3'5 $\frac{1}{2}$ "	1581	15'0" x 6'0"		
1536	5'11" x 3'6"	1582	20'0" x 8'0"		
1537	5'7" x 5'0"	1583	12'0" x 5'6"		
1538	5'7 $\frac{1}{2}$ " x 3'6"	1584	6'6" x 7'6"		
1539	9'0" x 4'7"	1585	8'6" x 4'6"		
1540	4'10" x 3'0"	1586	10'0" x 9'0"		
1541	6'6" x 6'0 $\frac{1}{2}$ "	1587	11'0" x 7'6"		
1542	10'9 $\frac{1}{2}$ " x 6'7 $\frac{1}{2}$ "	1588	13'10" x 11'0 $\frac{1}{2}$ "		
1543	7'6" x 5'10"	1589	9'0" x 7'0"		
1544	5'2" dia.	1590	6'9 $\frac{1}{2}$ " x 3'0"		
1545	5'2" dia.				

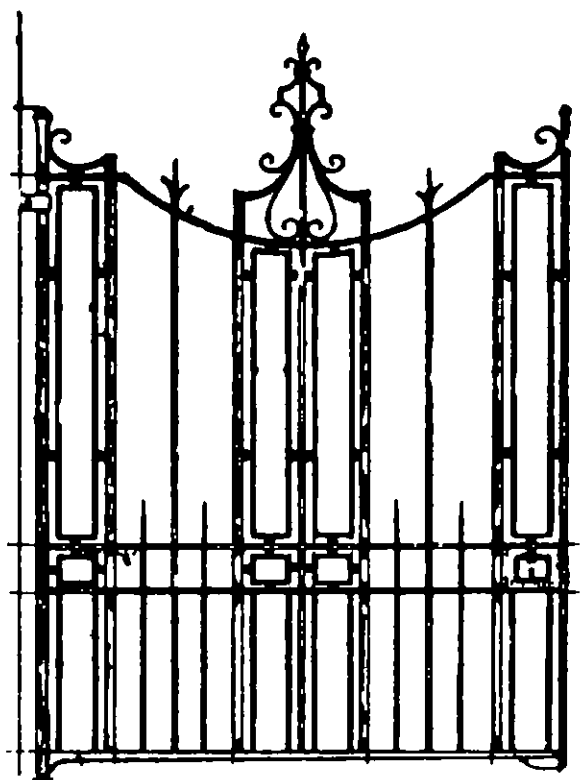

1500

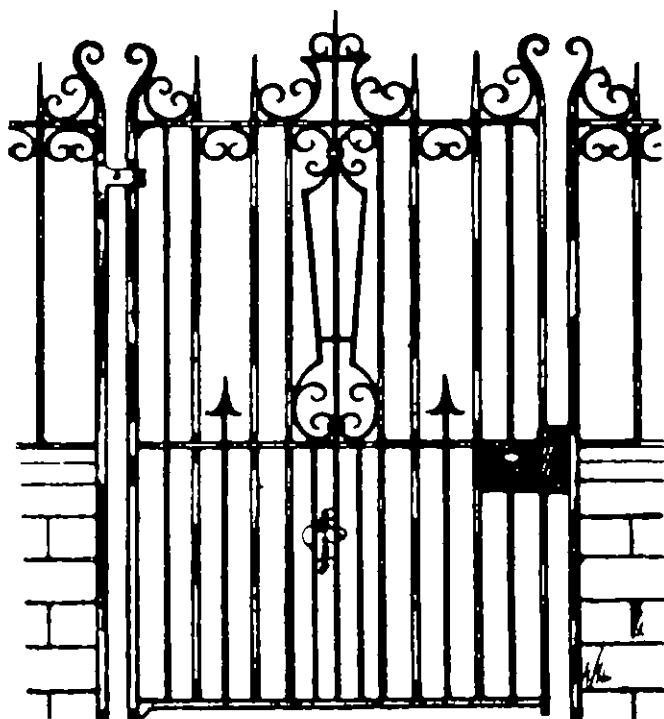

1502

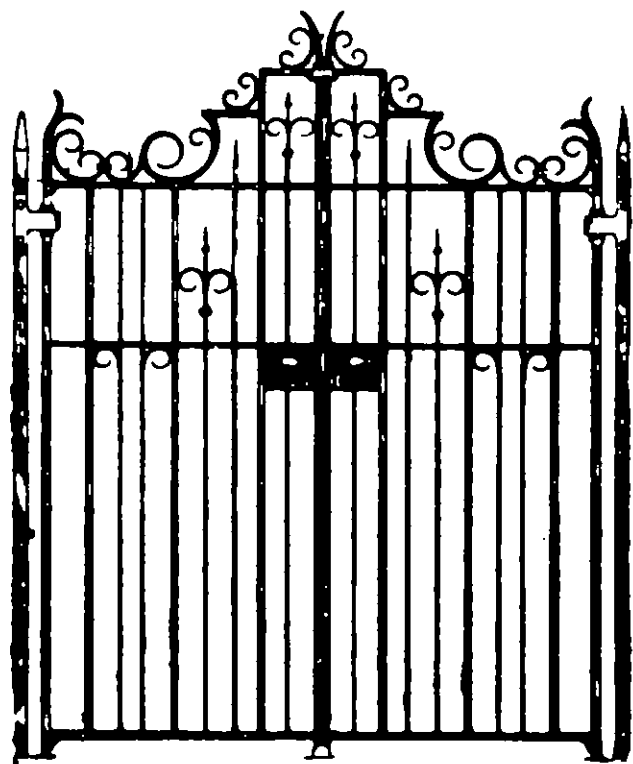

1501

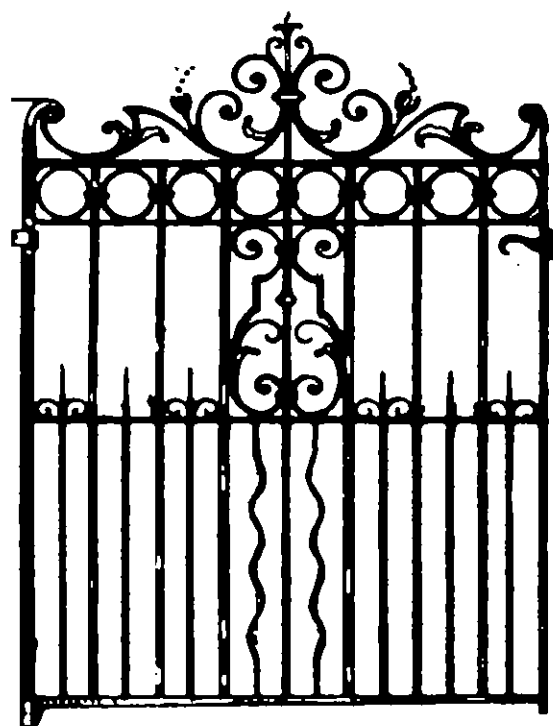

1503

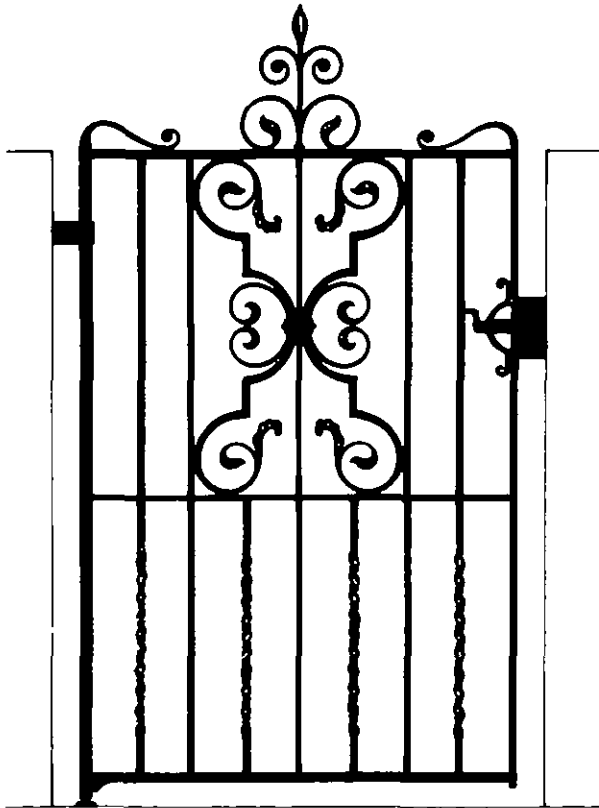

1504

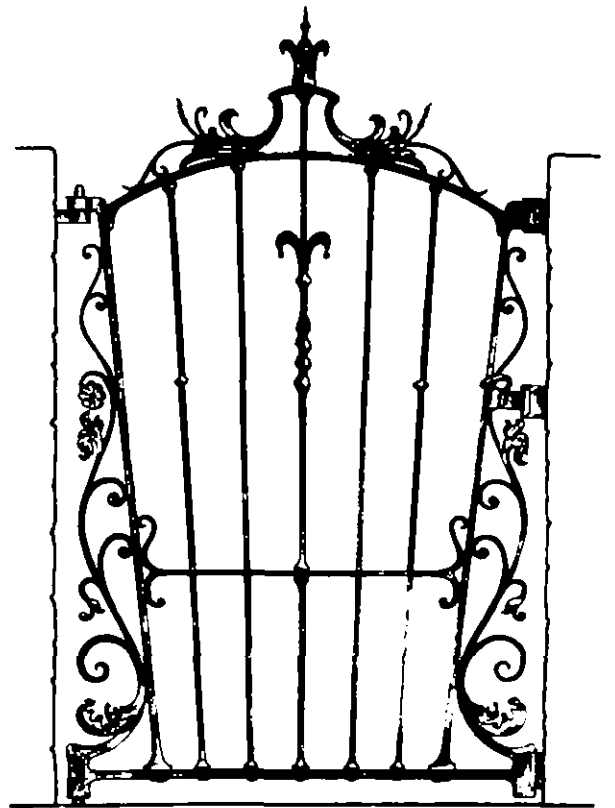

1506

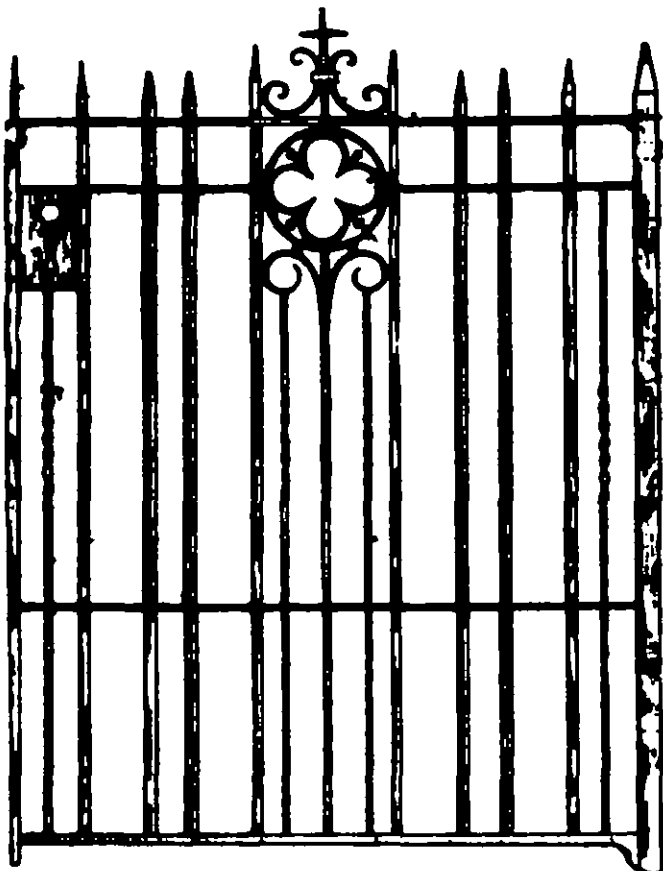

1505

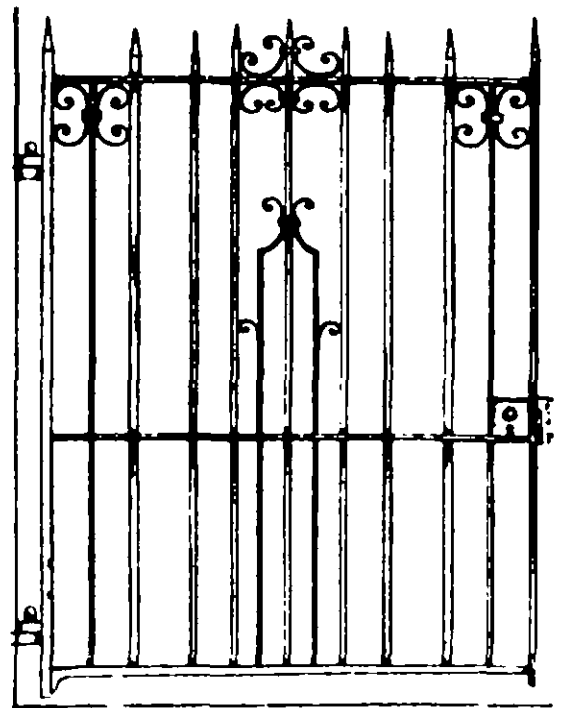

1507

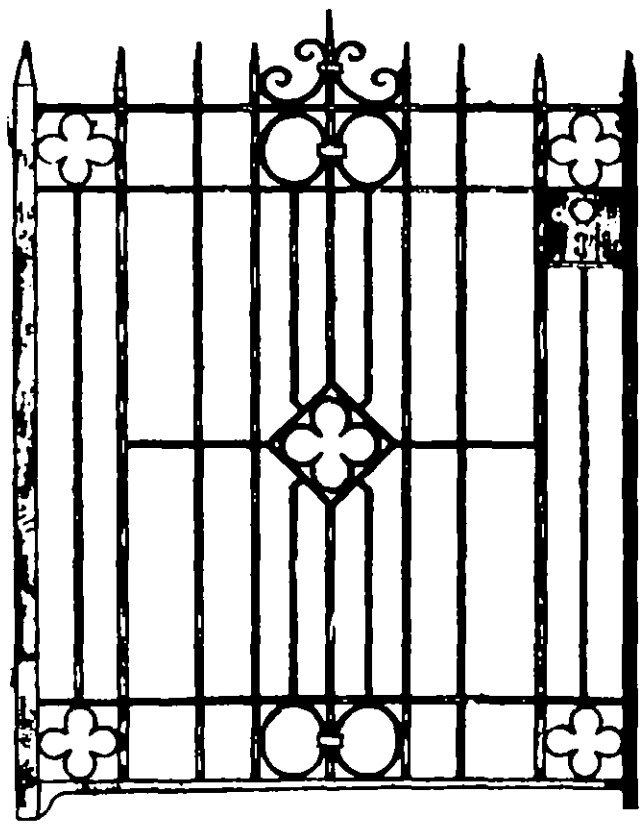

1508

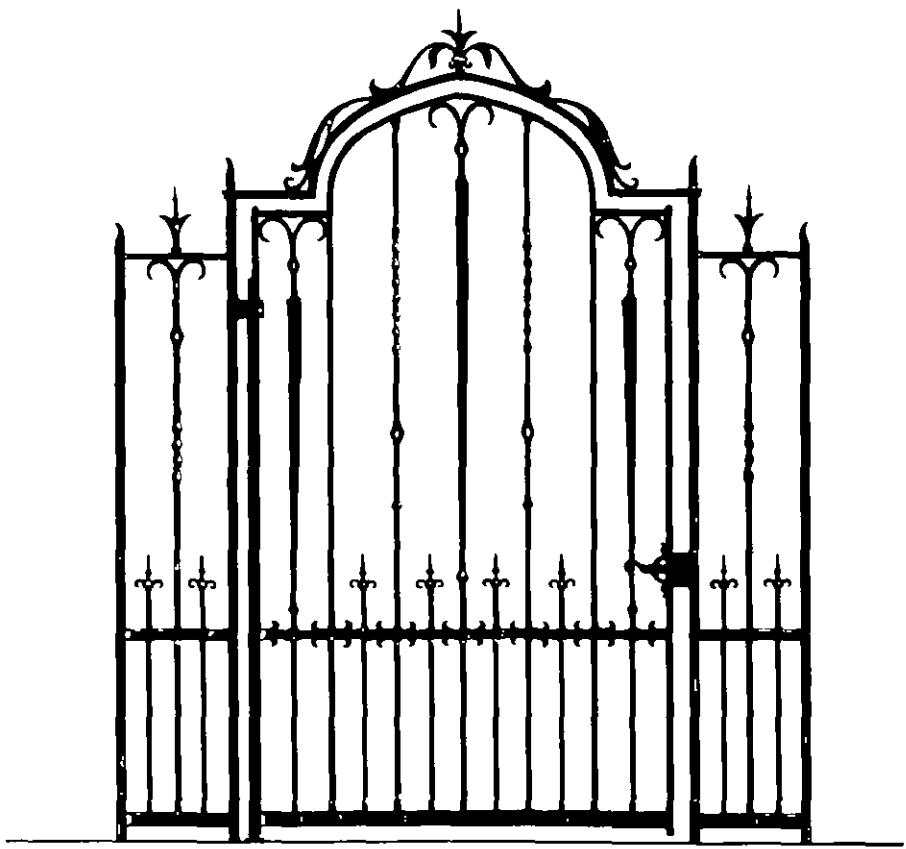

1509

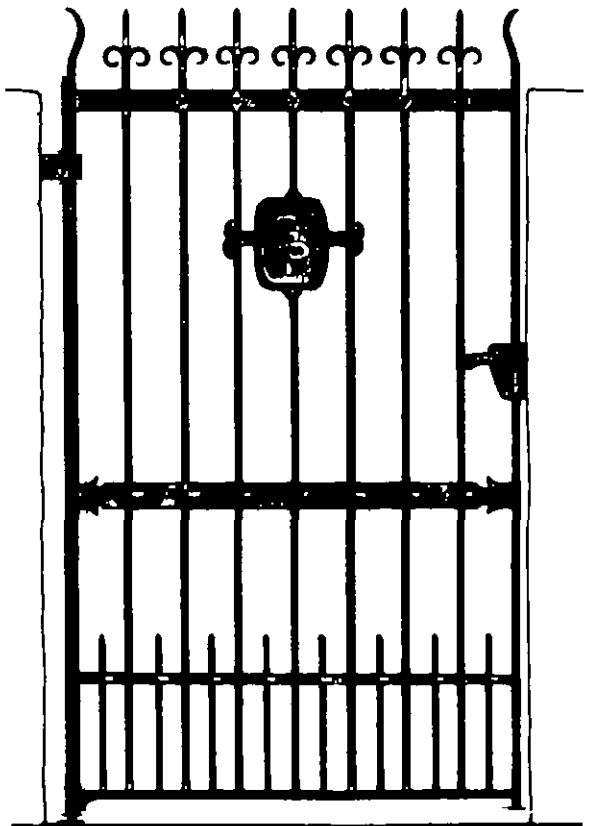

1510

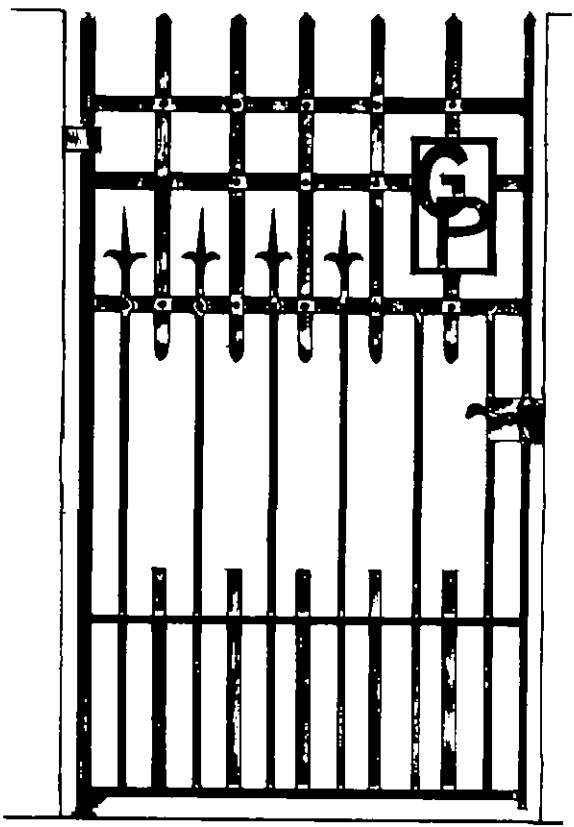

1512

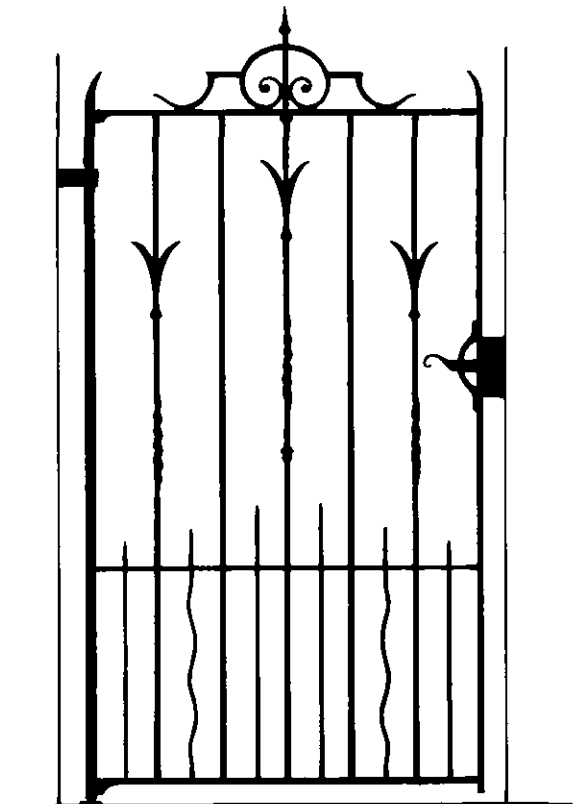

1511

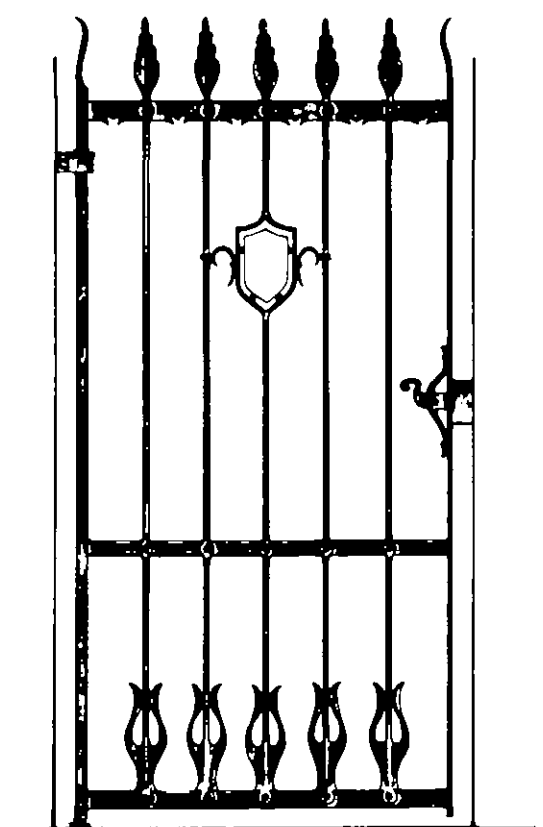

1513

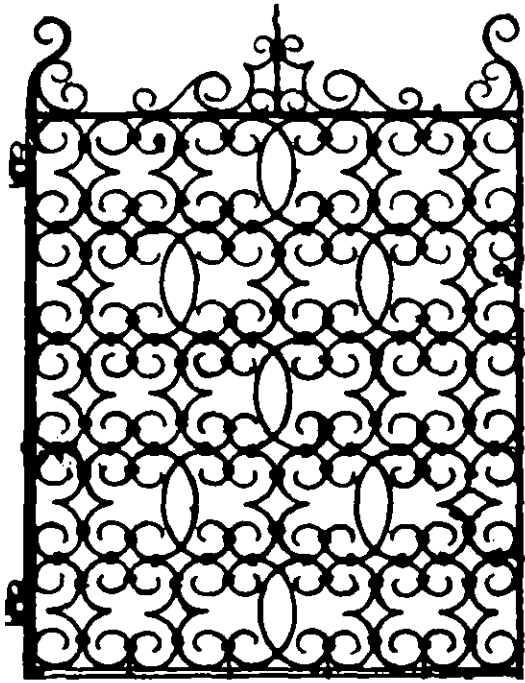

1514

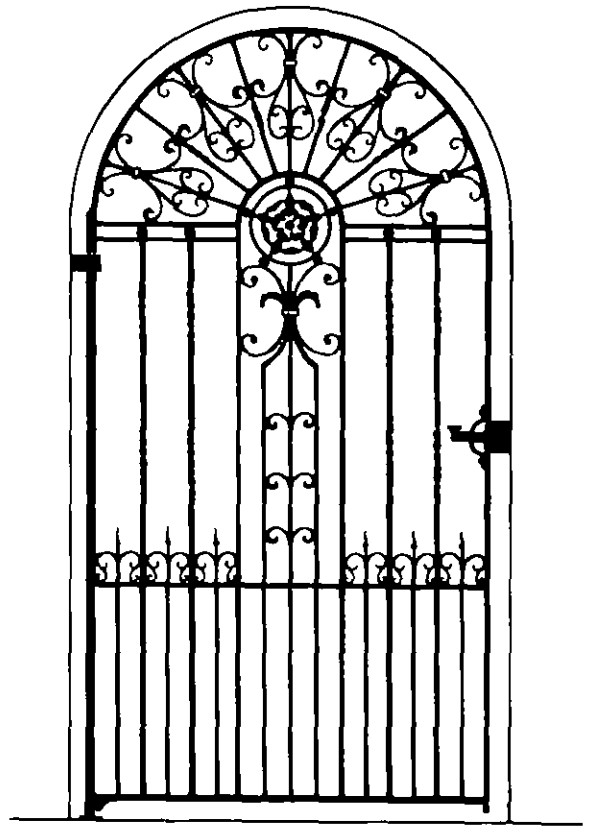

1516

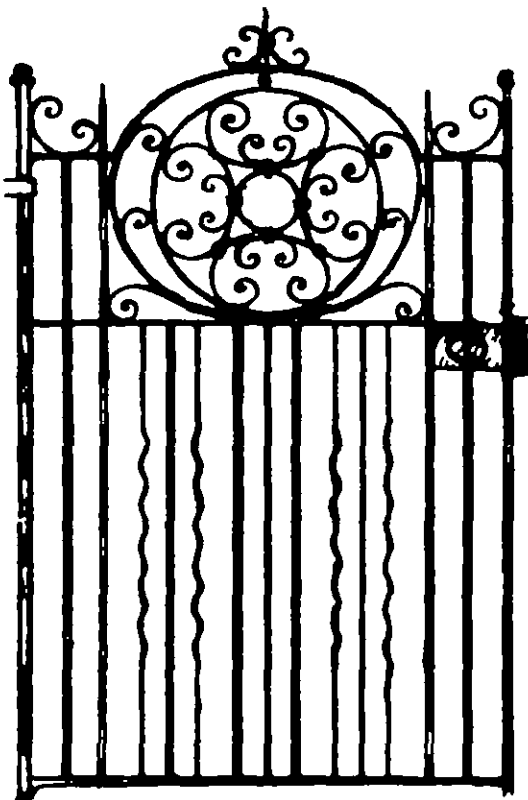

1515

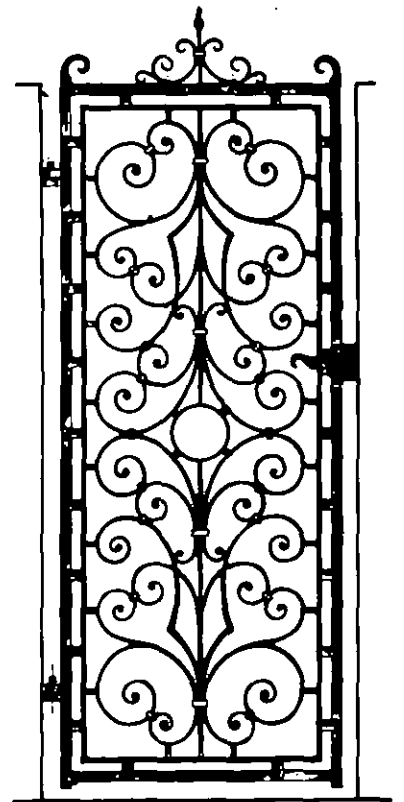

1517

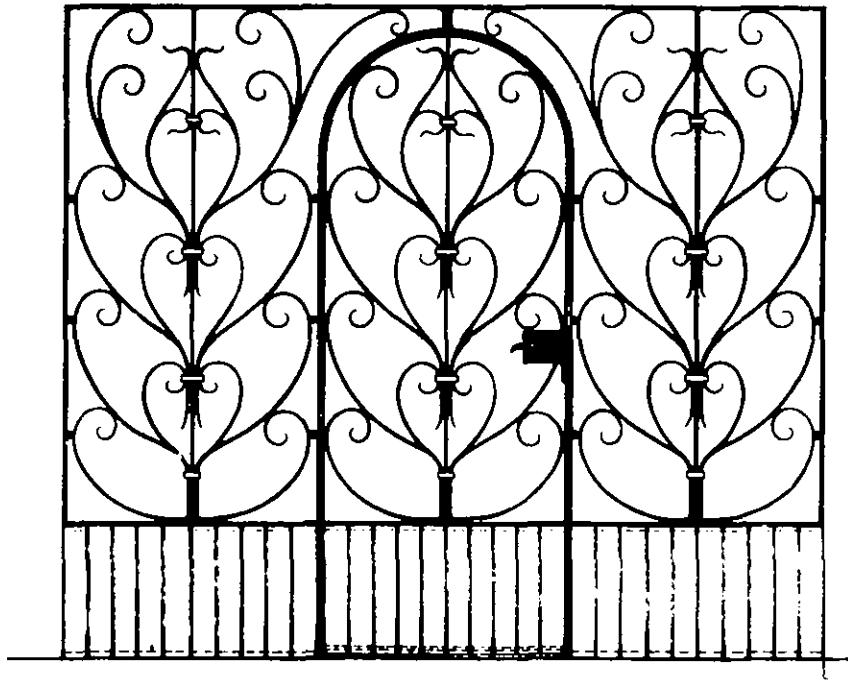

1518

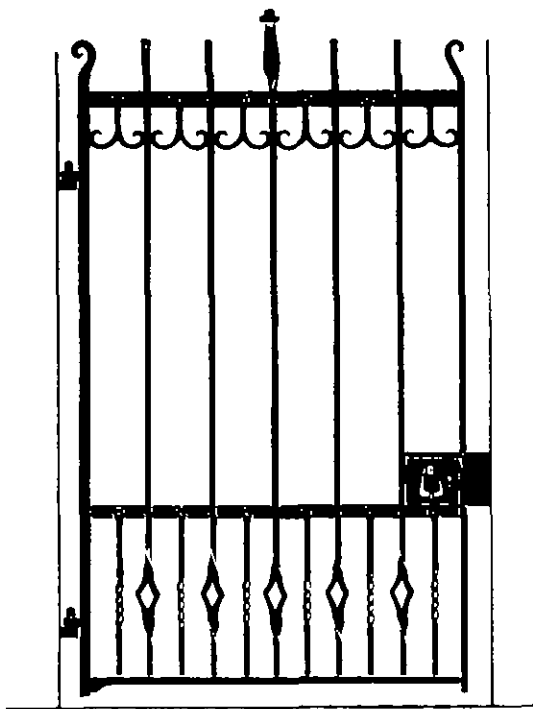

1519

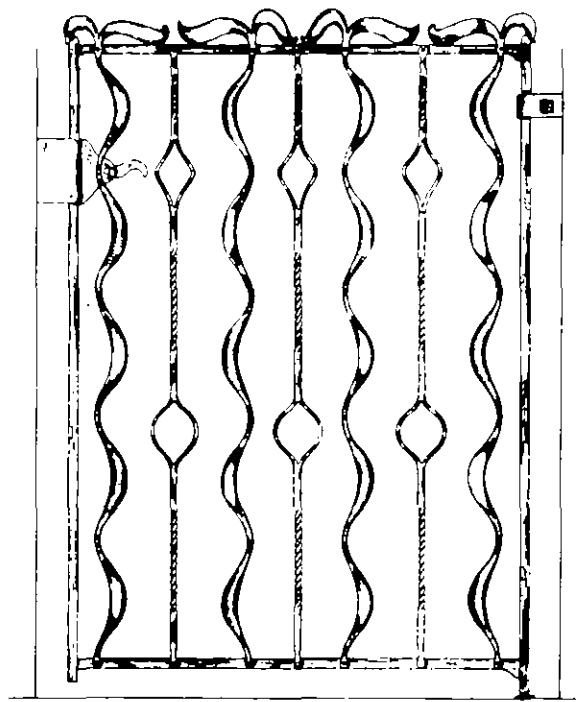

1520

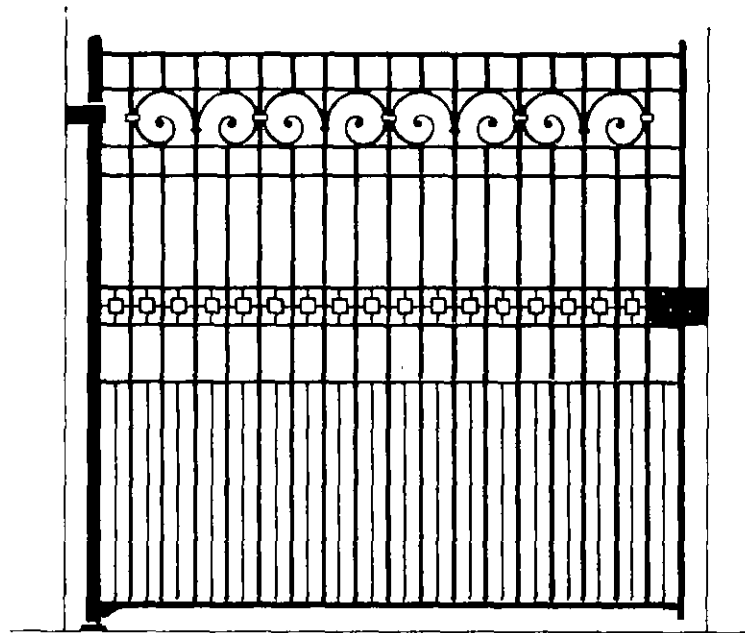

1521

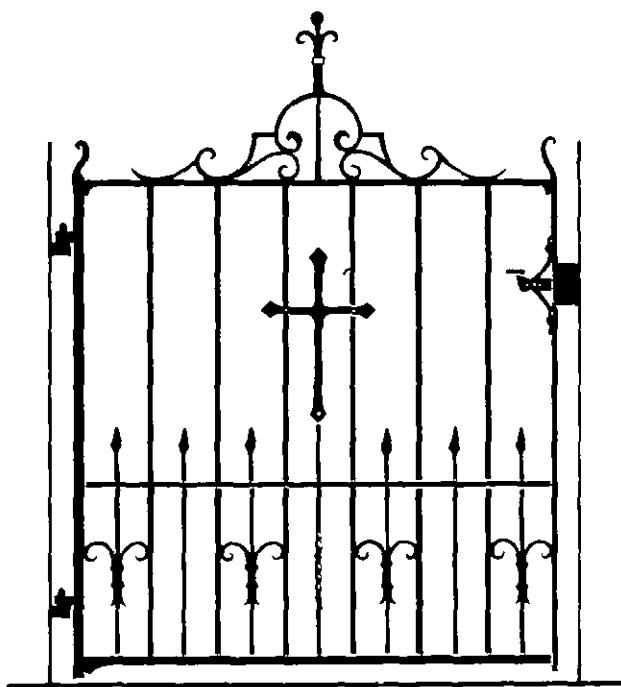

1522

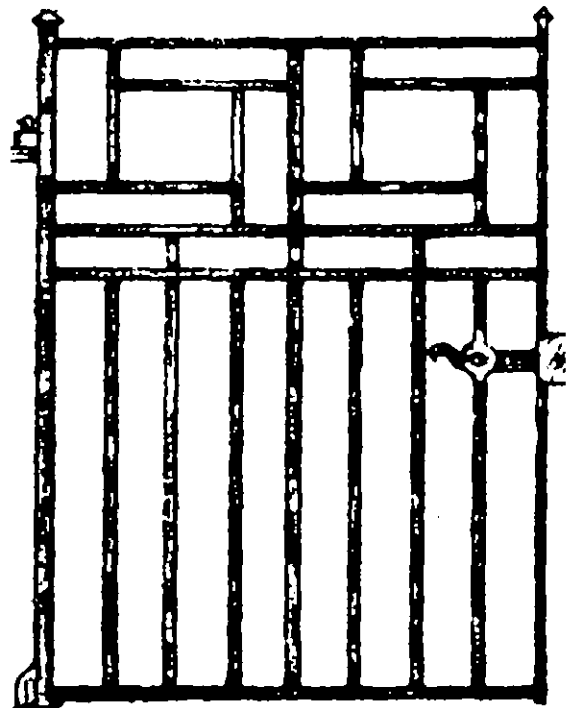

1523

1524

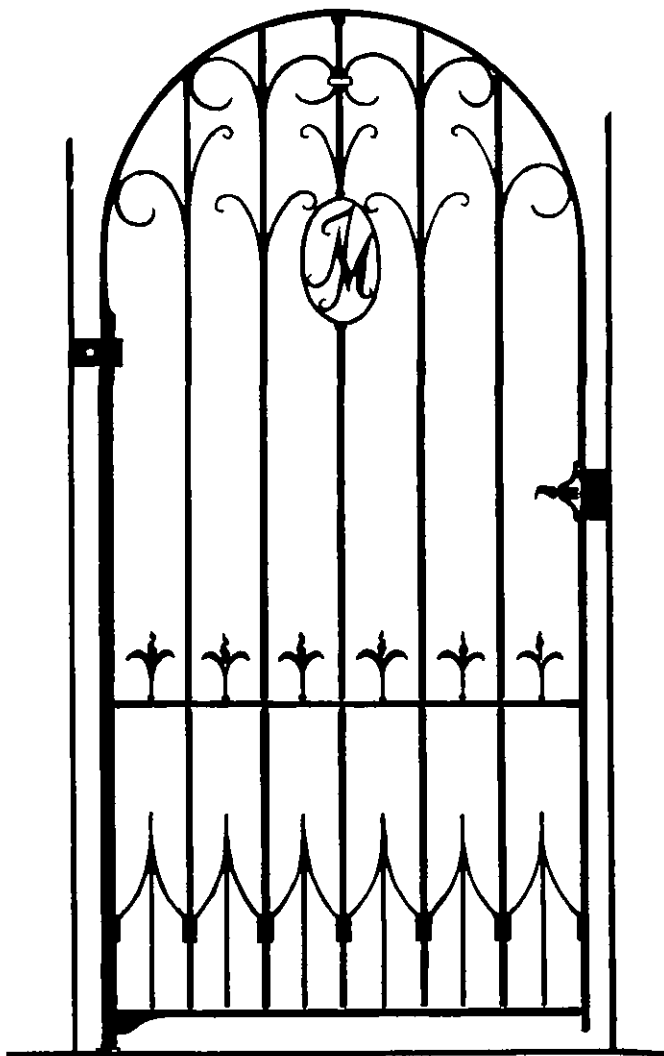

1525

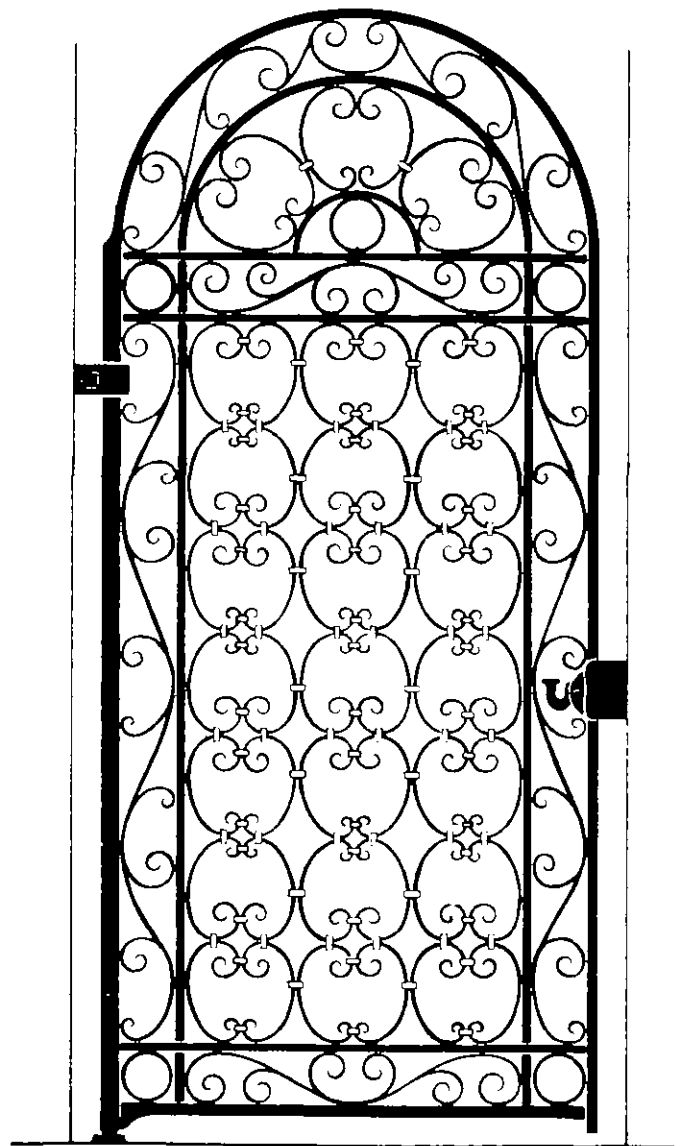

1526

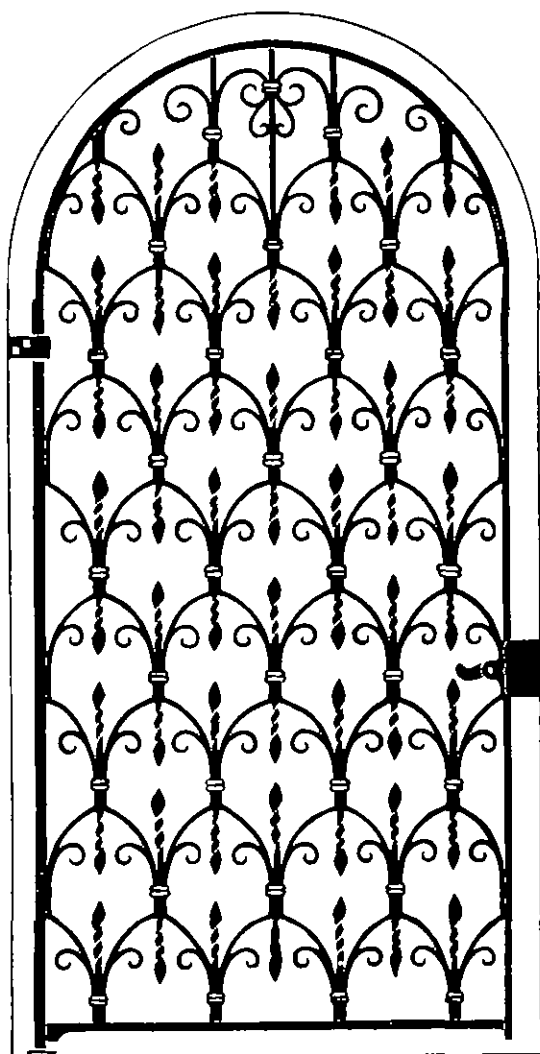

1527

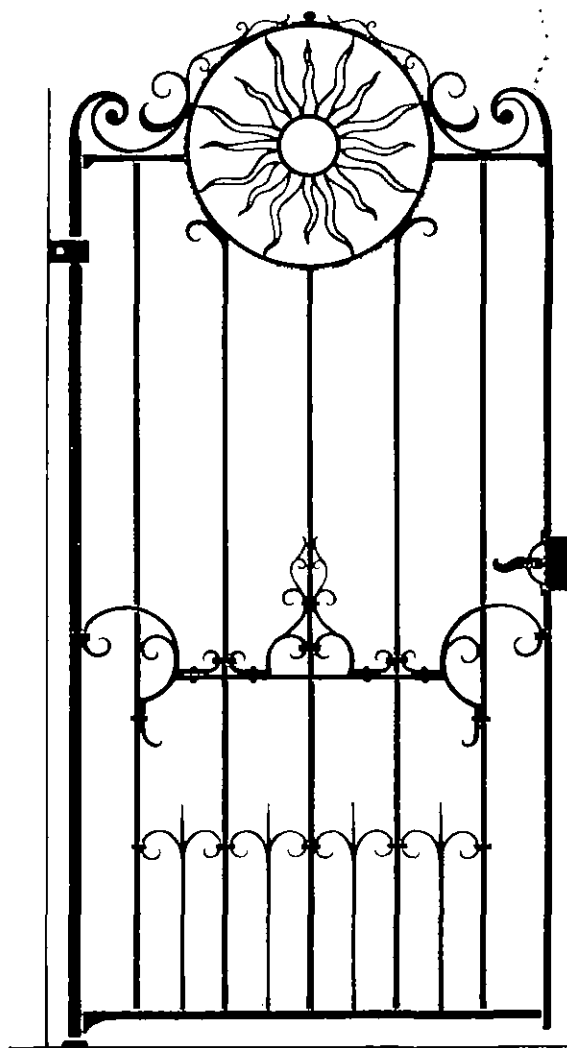



1528

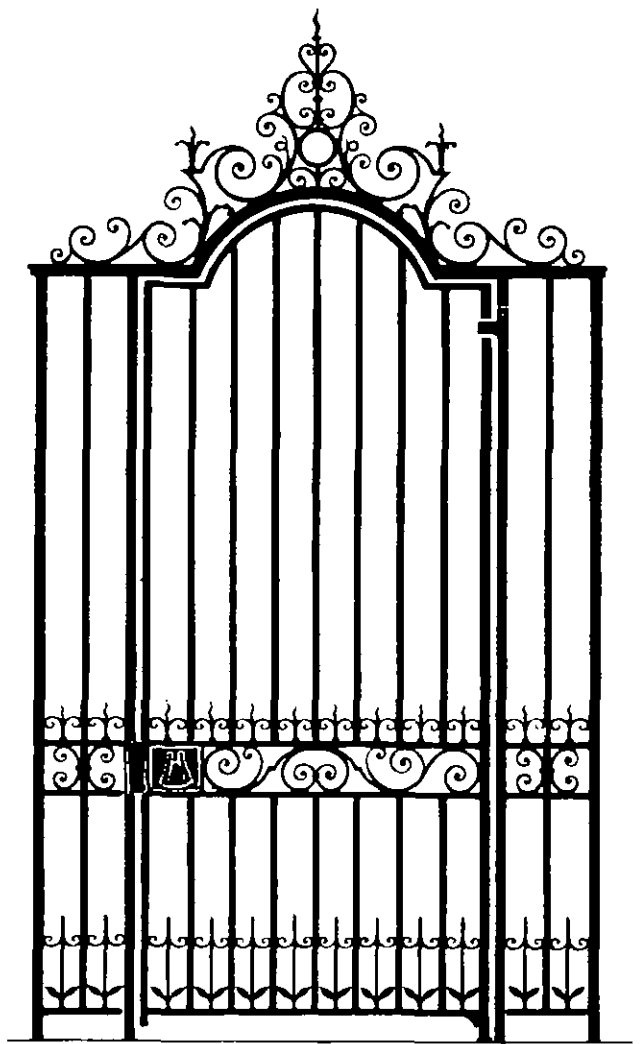

1530

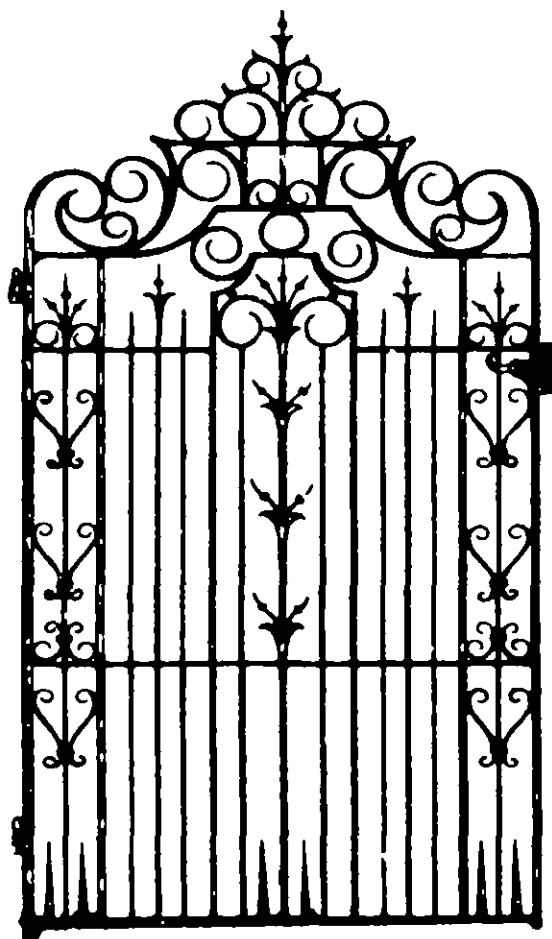

1529

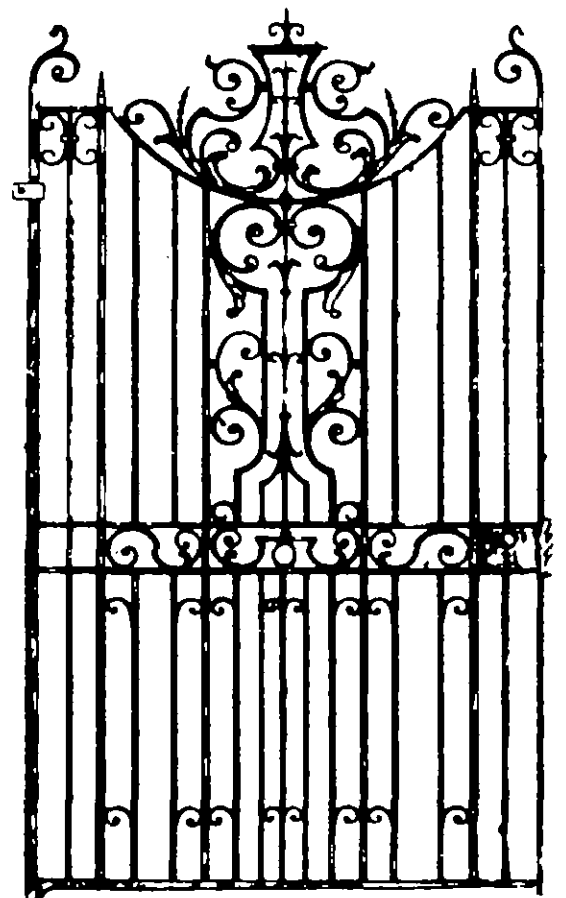

1531

1532

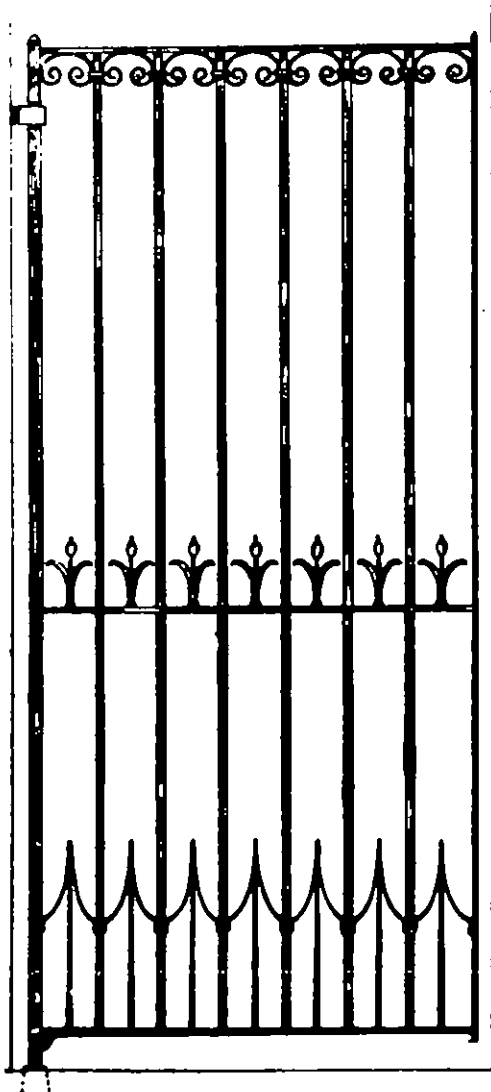
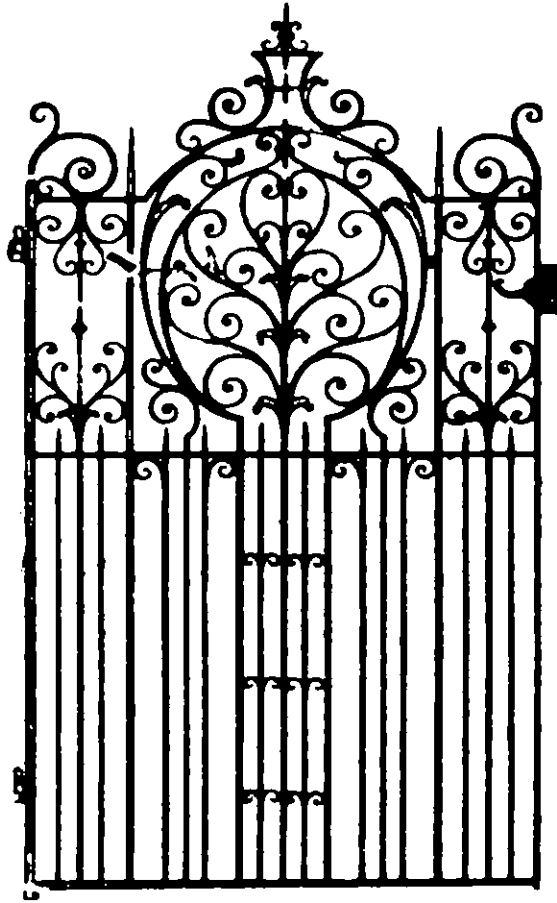

1533

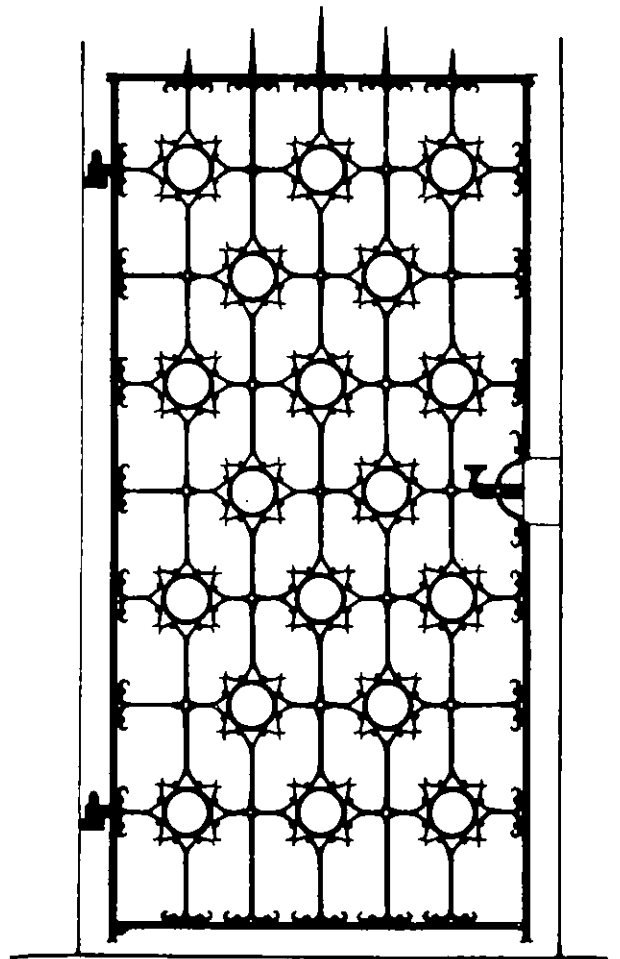

1534

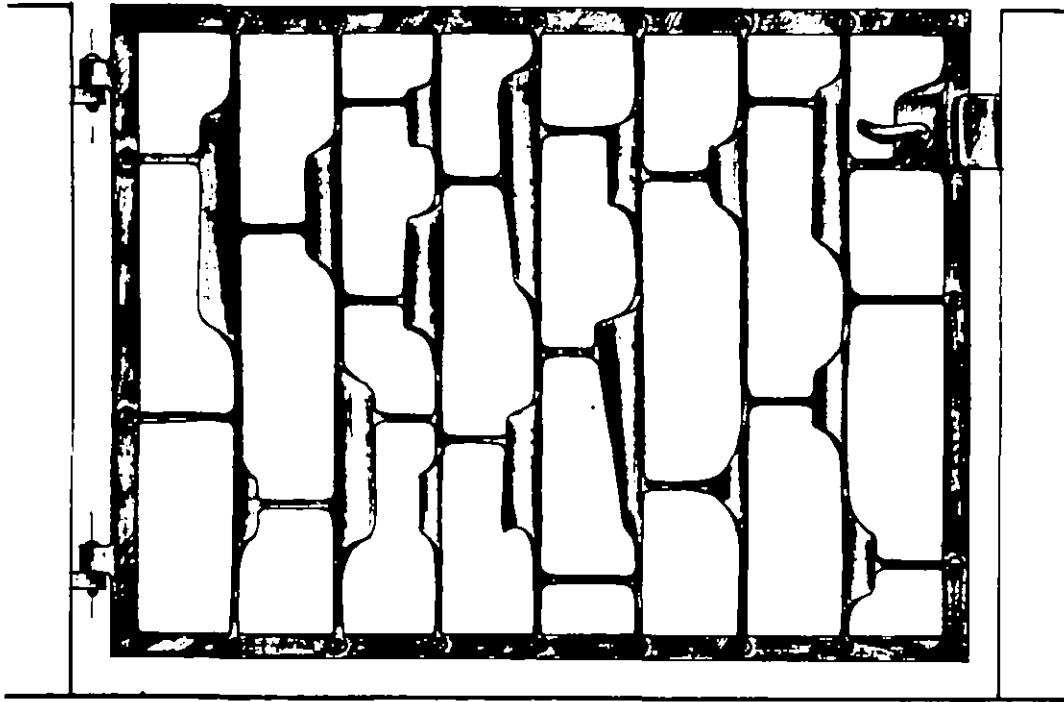

1535

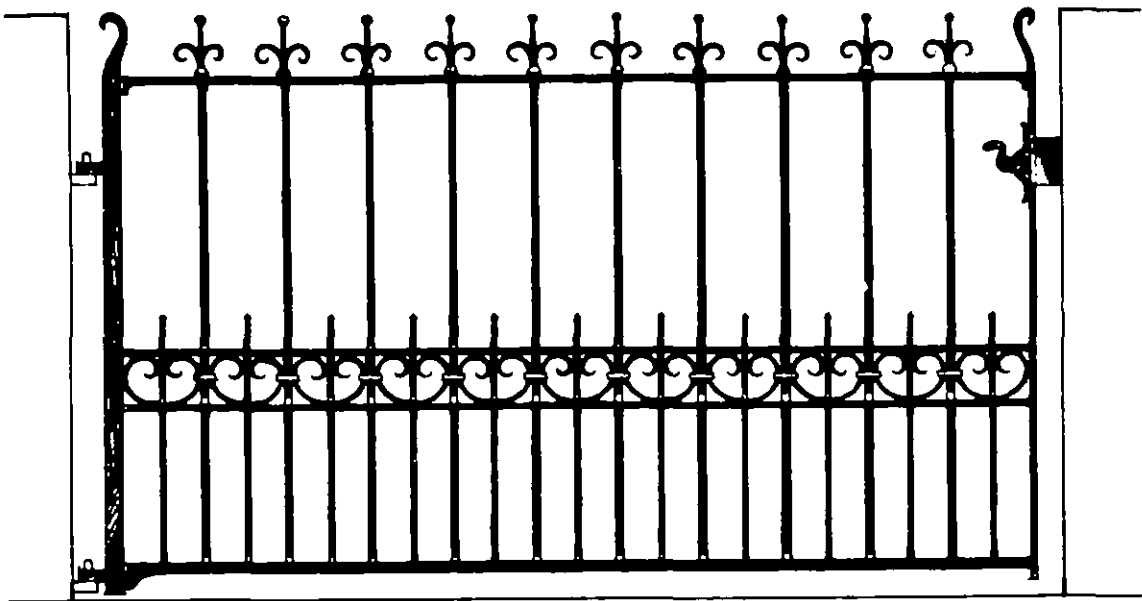

1536



1537

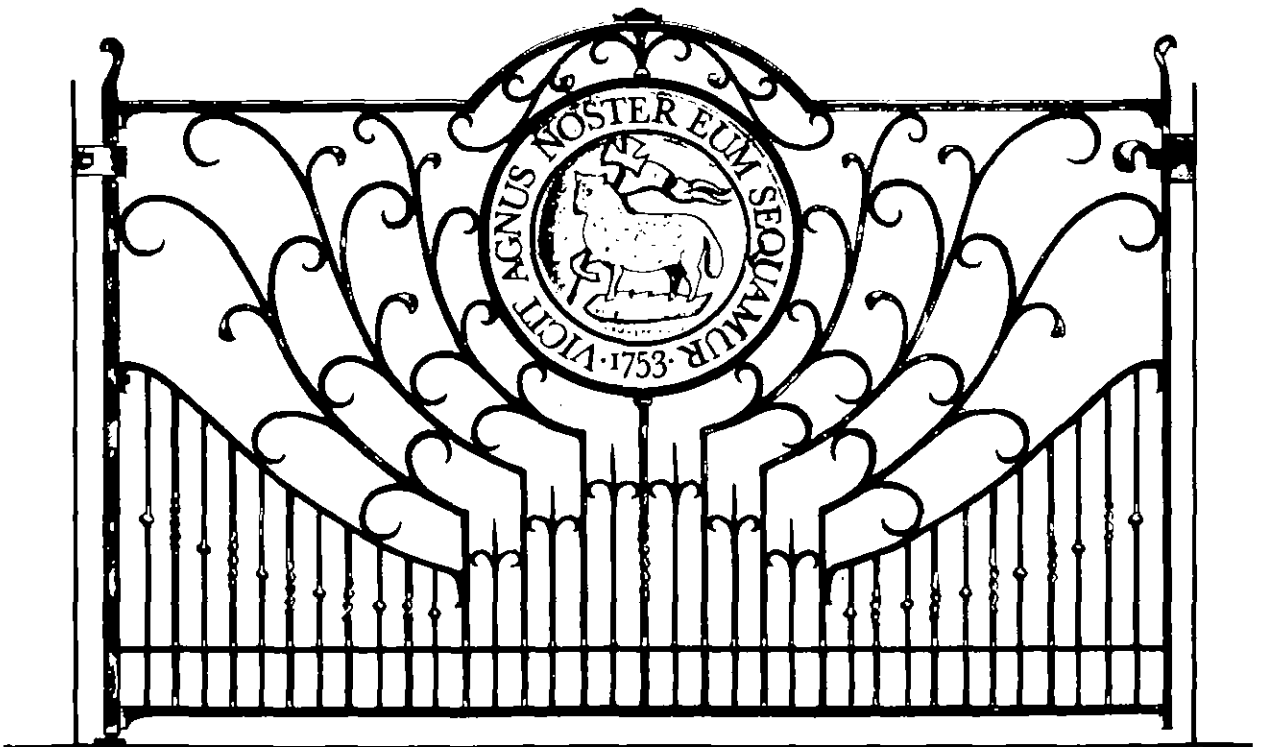

1538

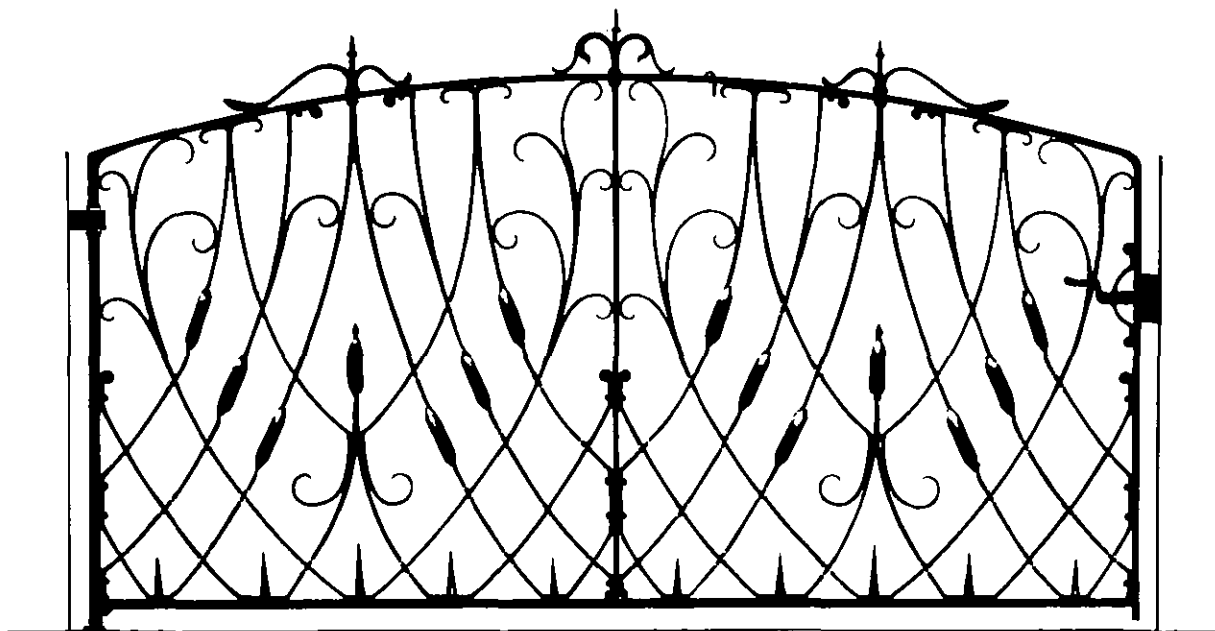

1539

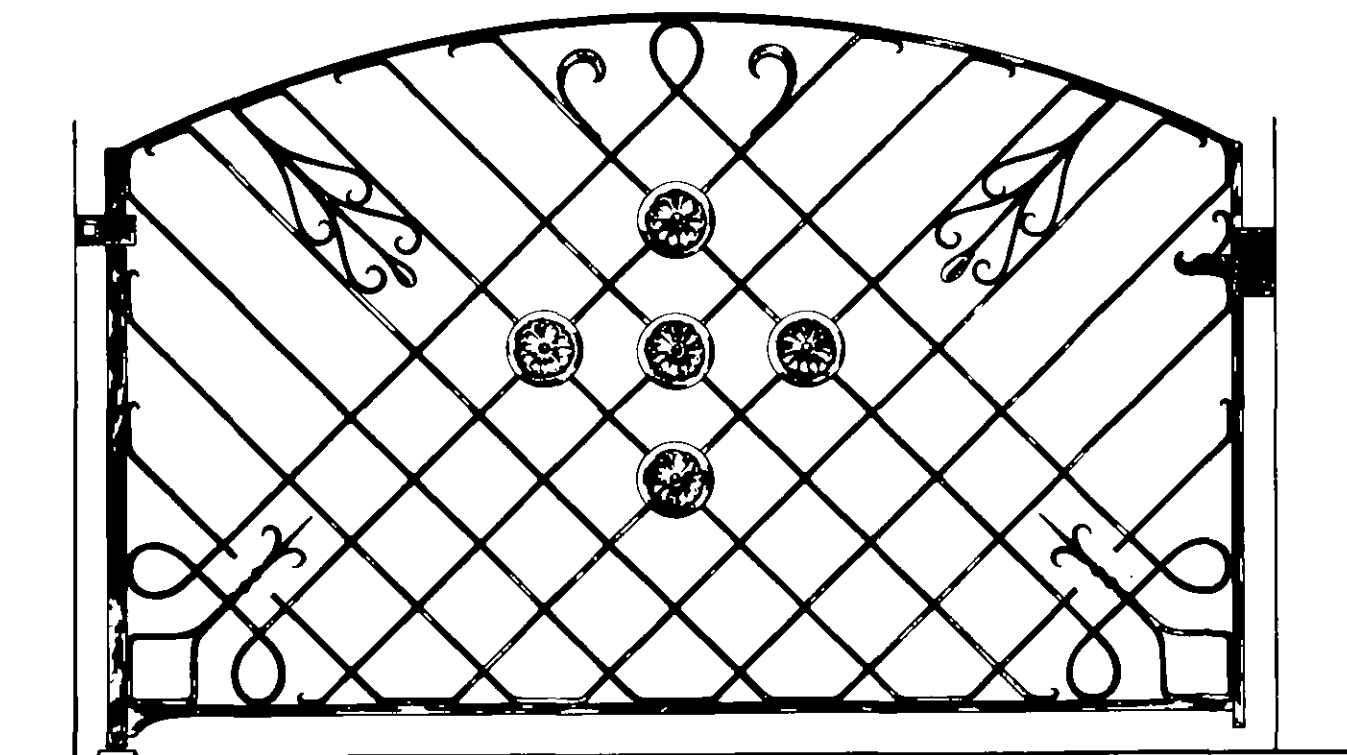

1540

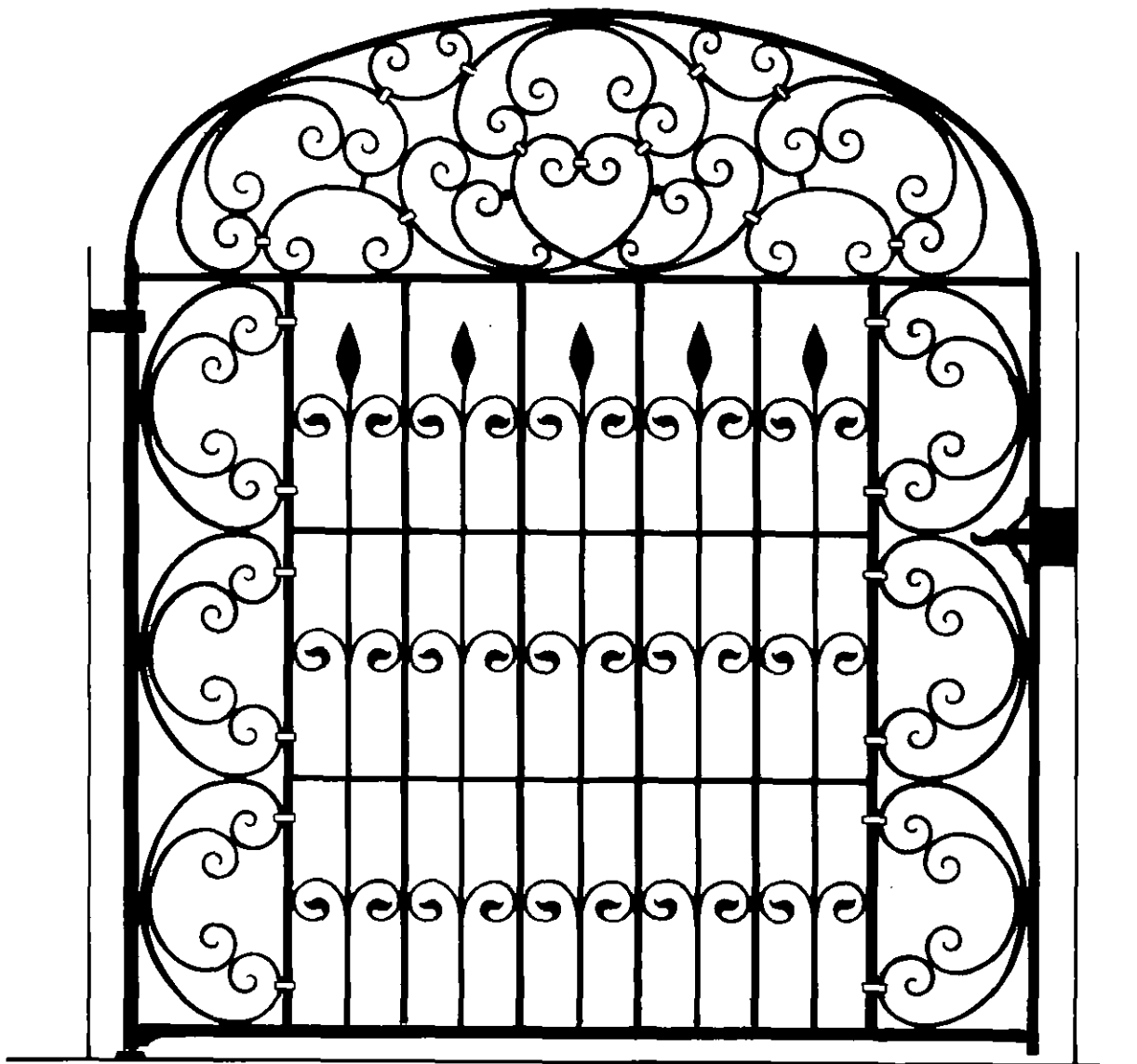

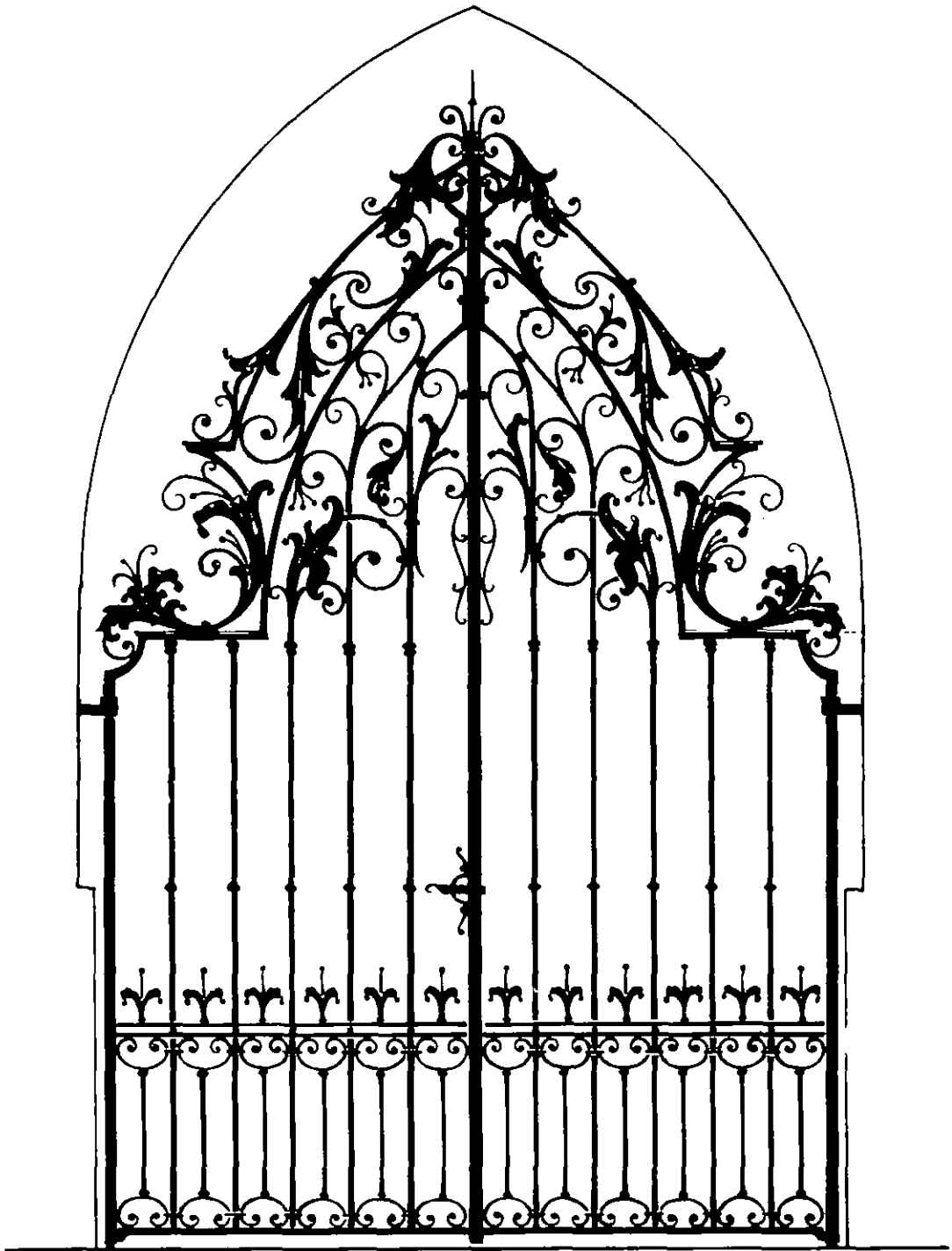

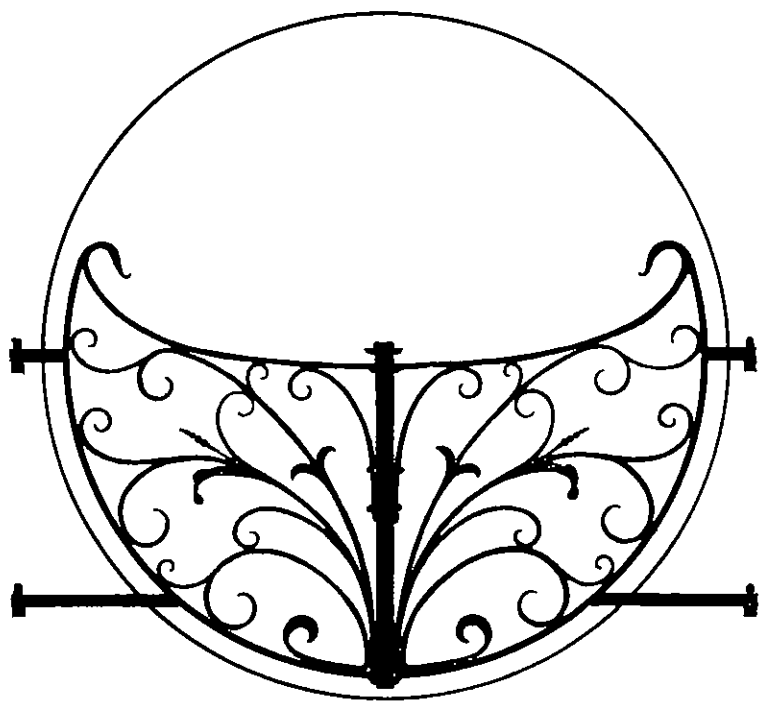

1543

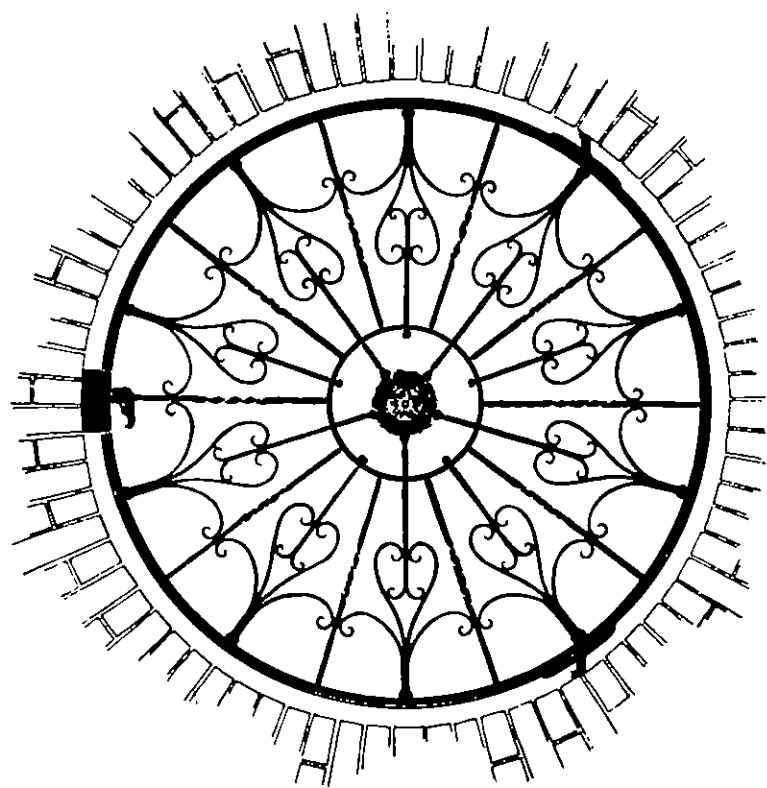

1544

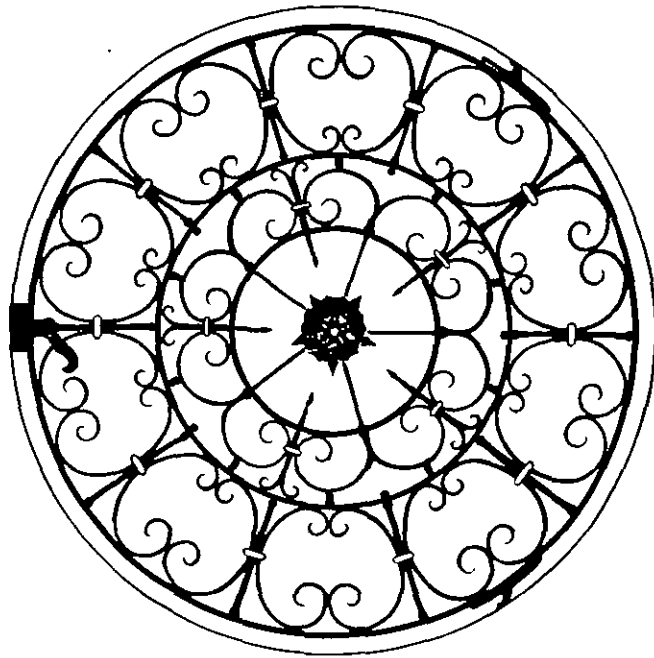

1545

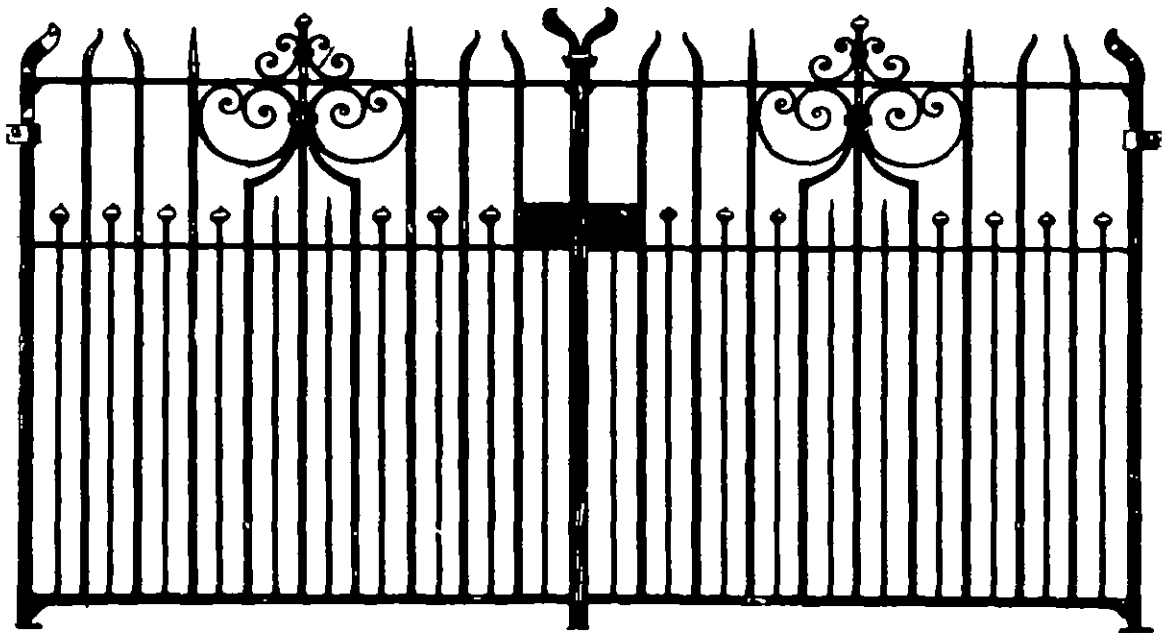

1546

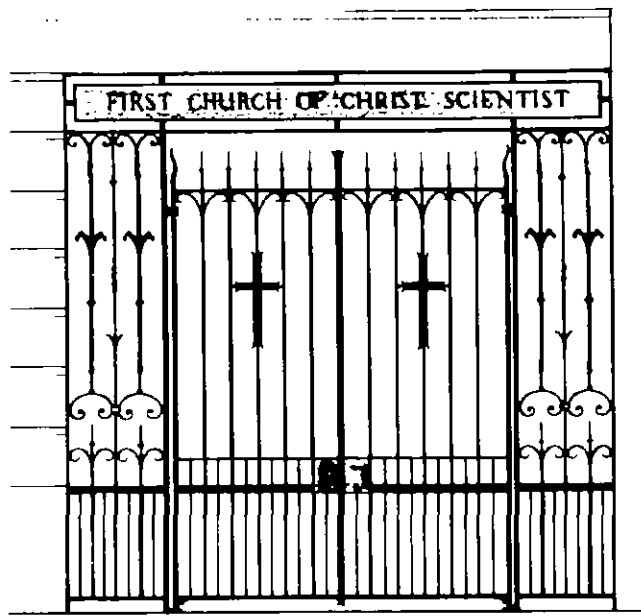

1547

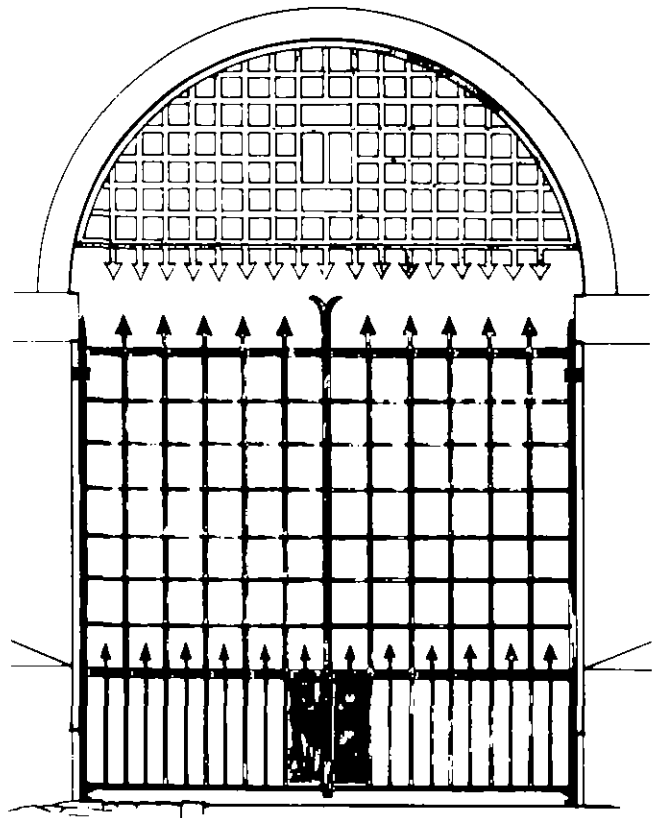

1549

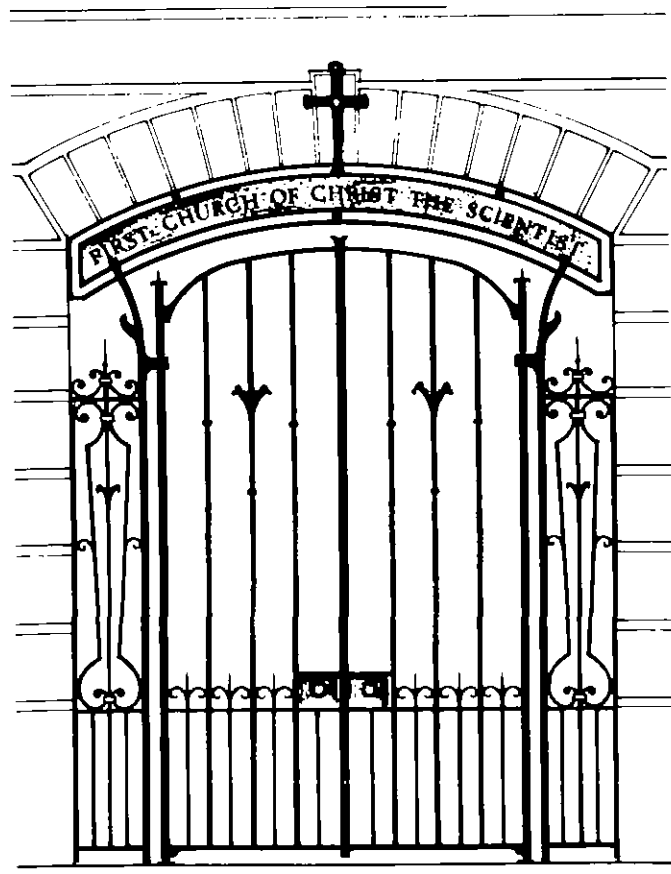

1548

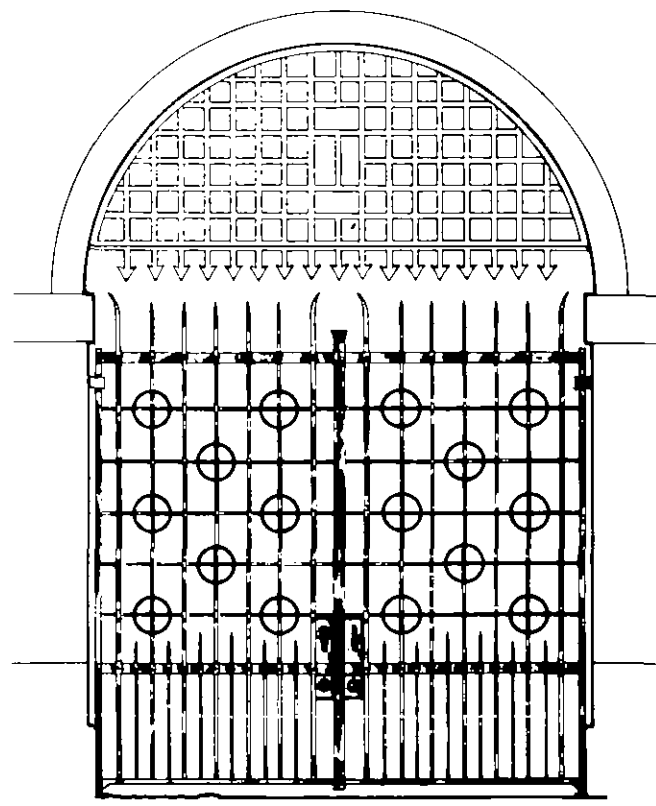

1550

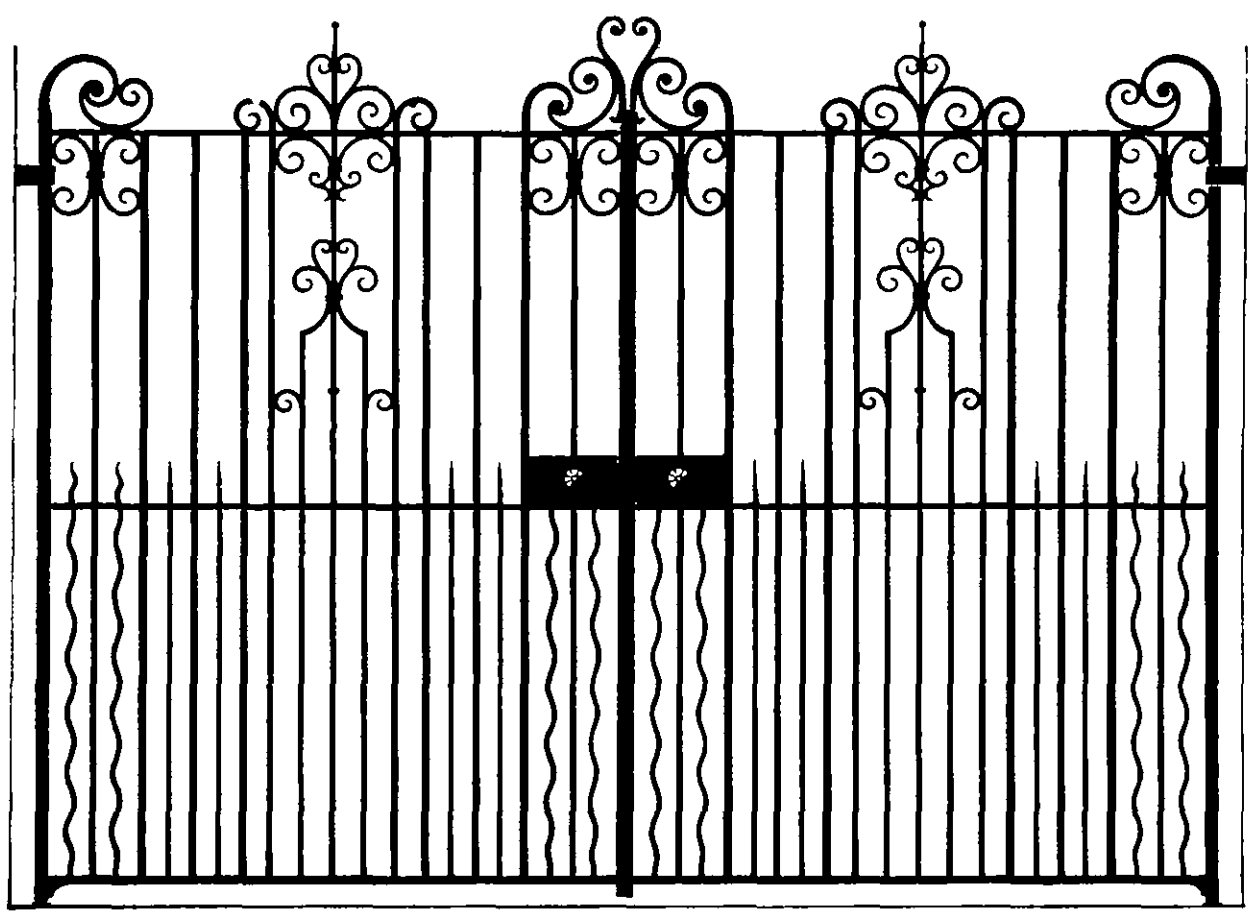

1551

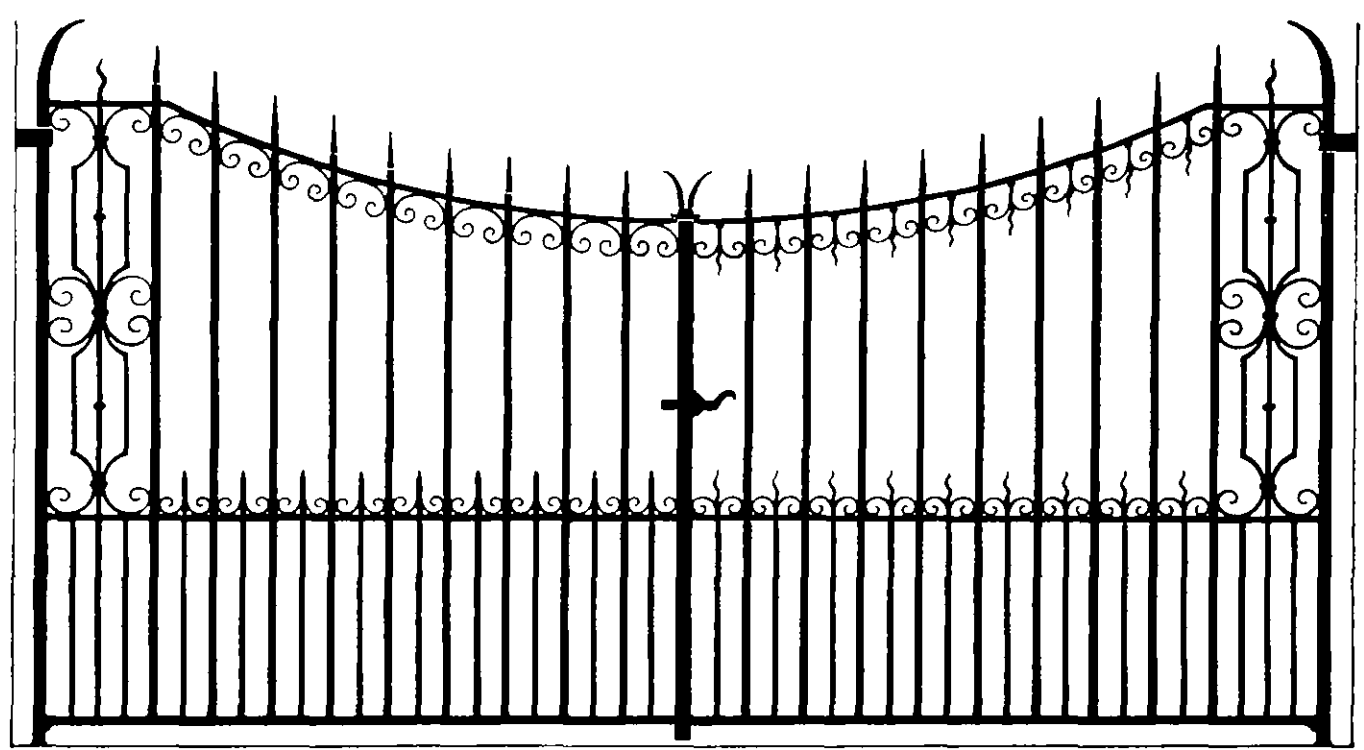

1552

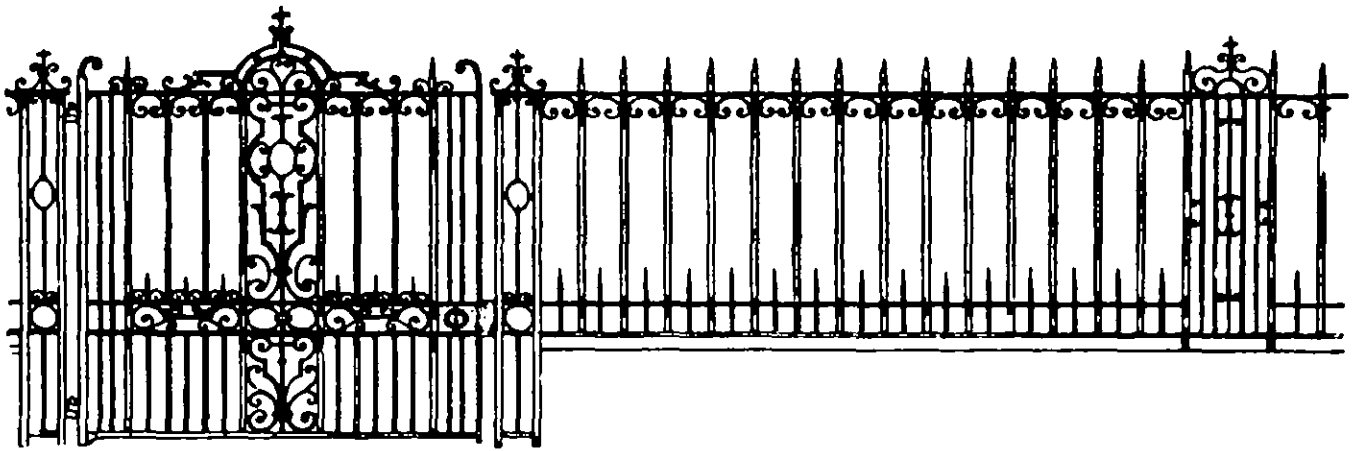

1553

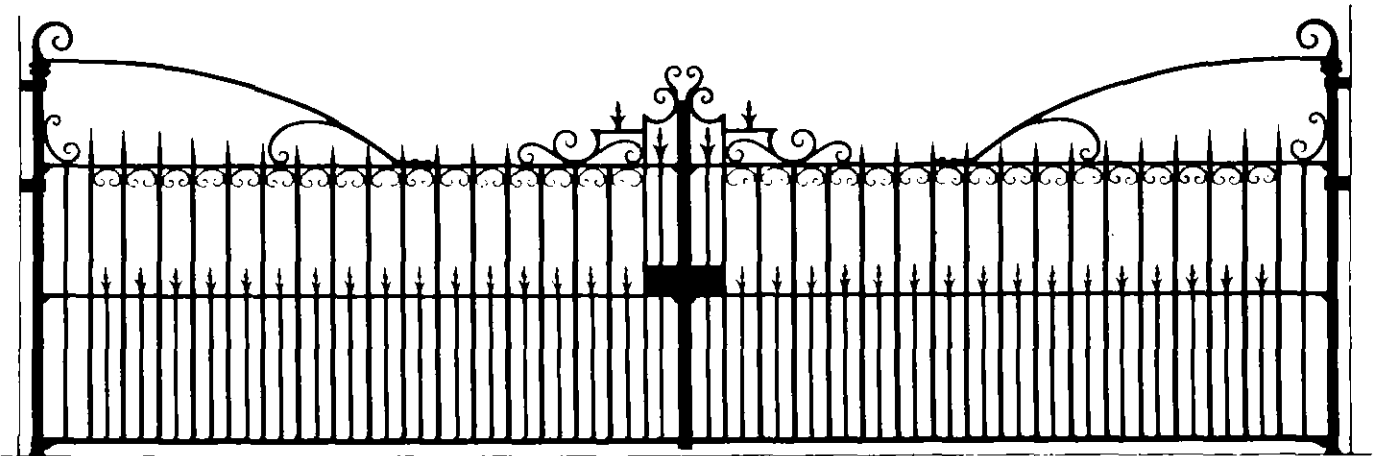

1554

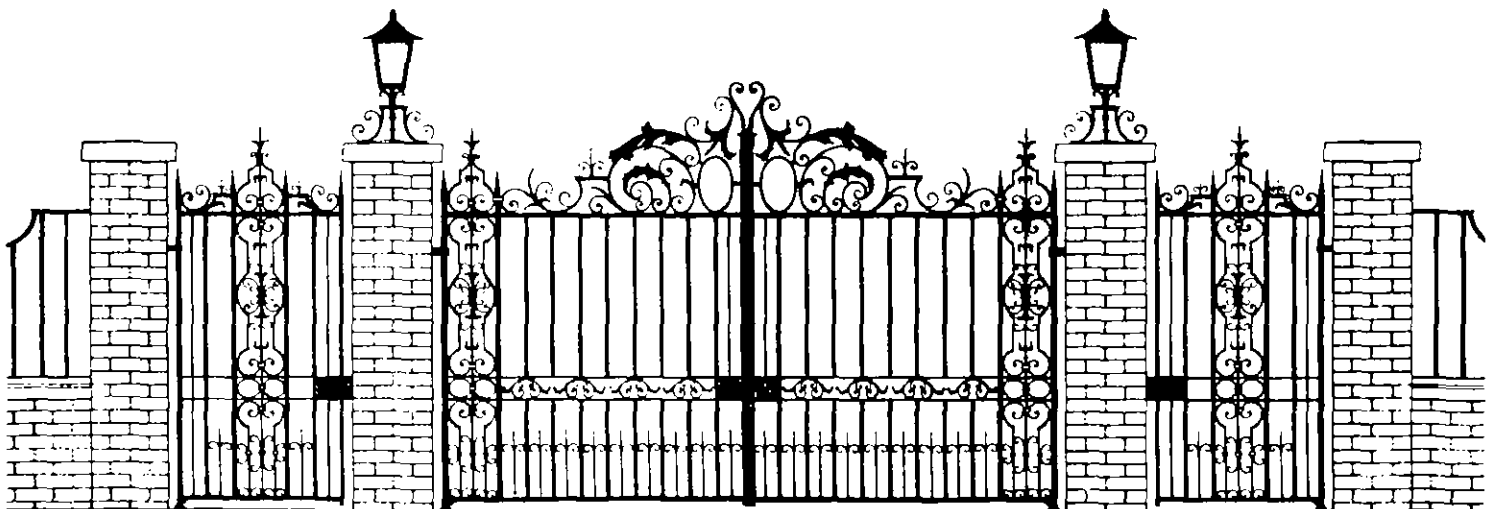

1555

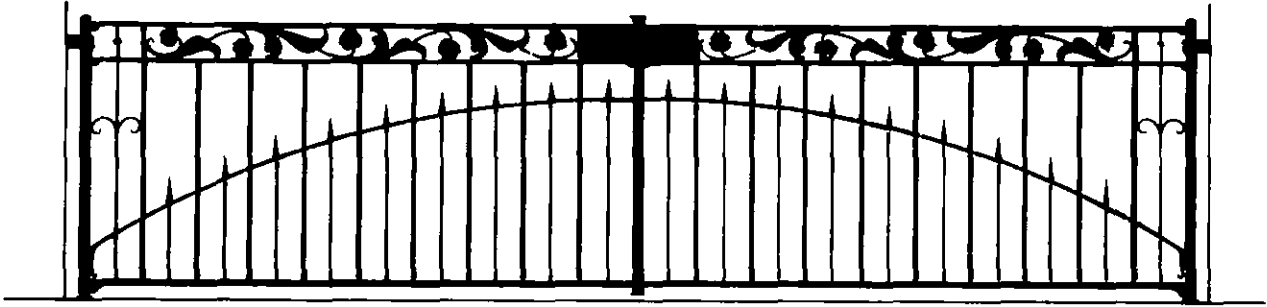

1556

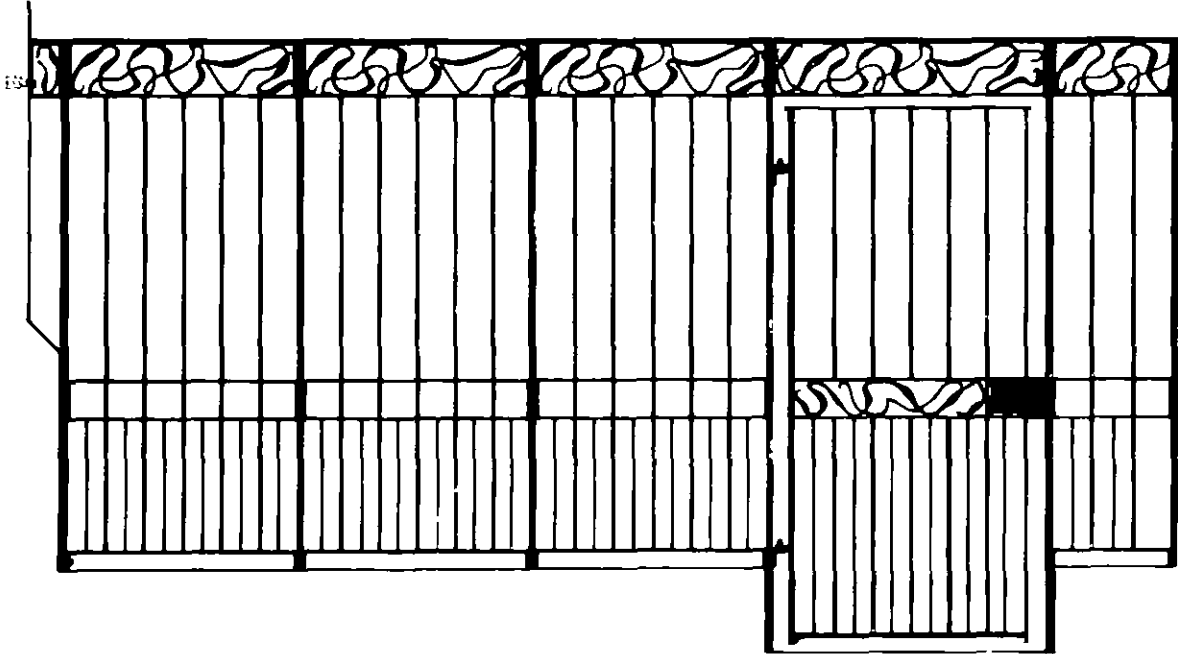

1557

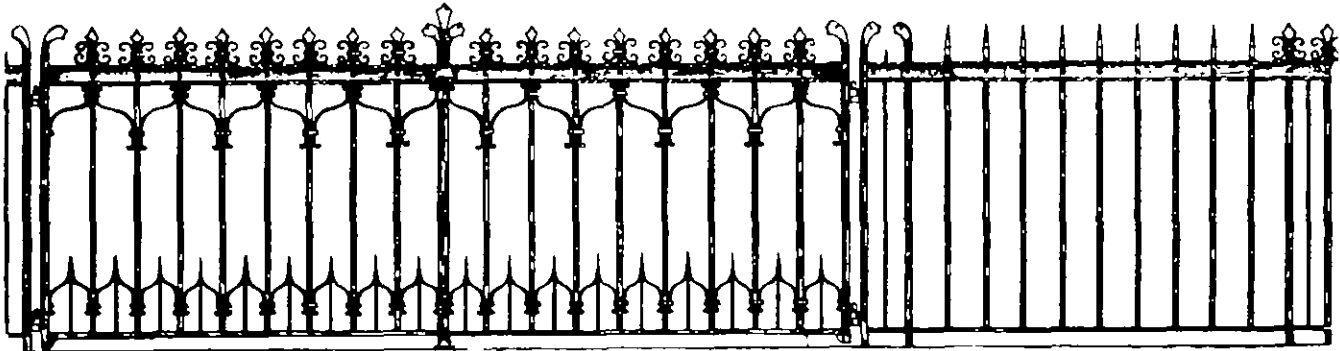

1558

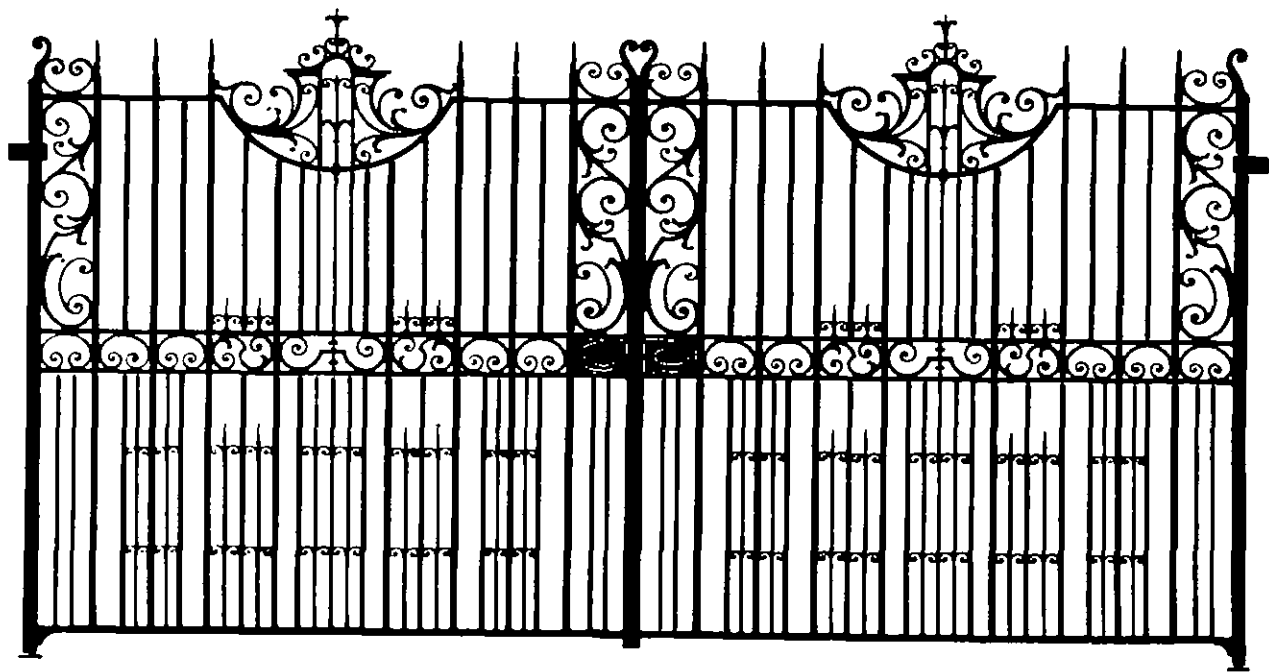

1559

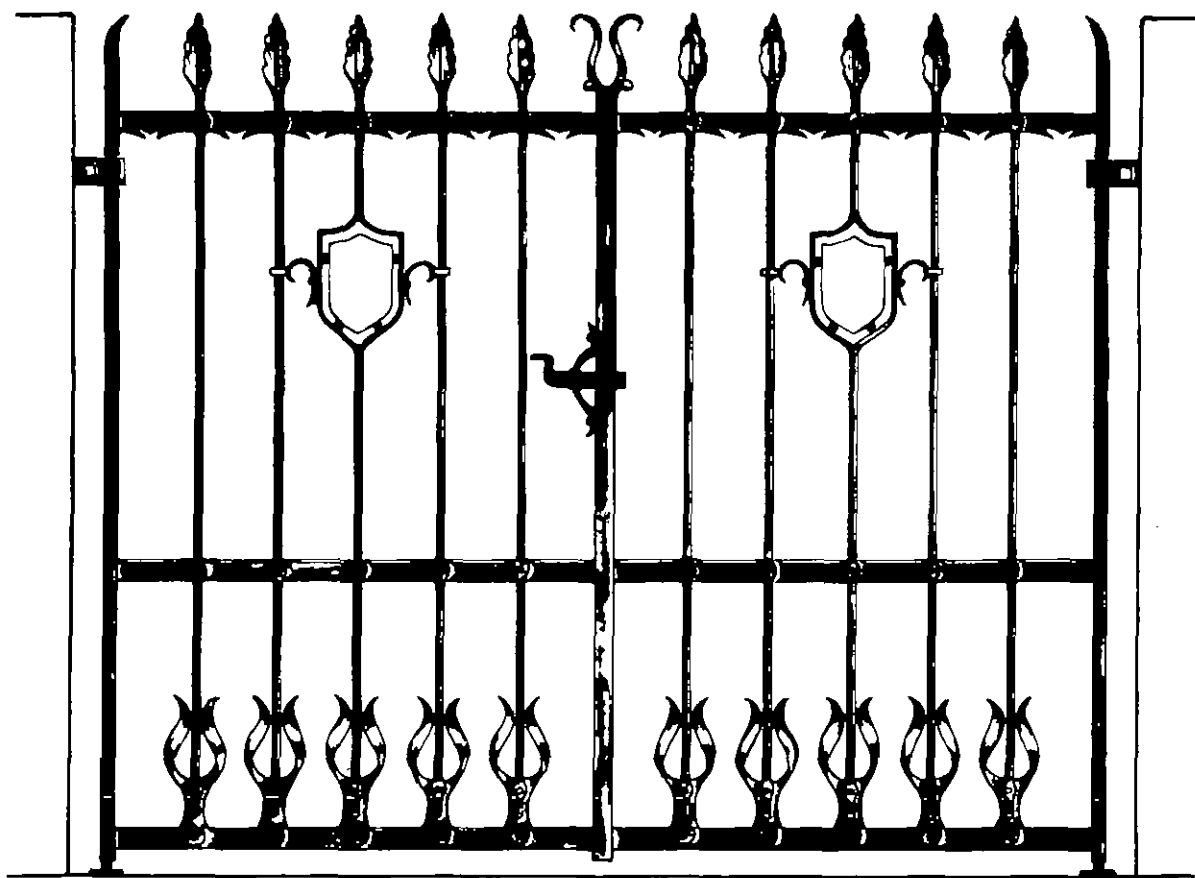

1560

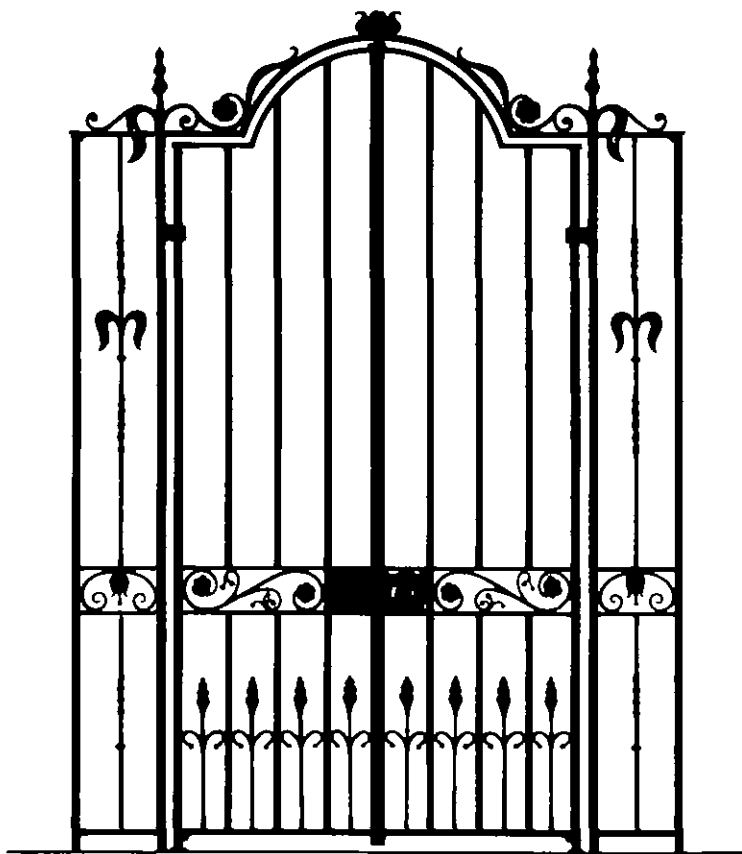

1561

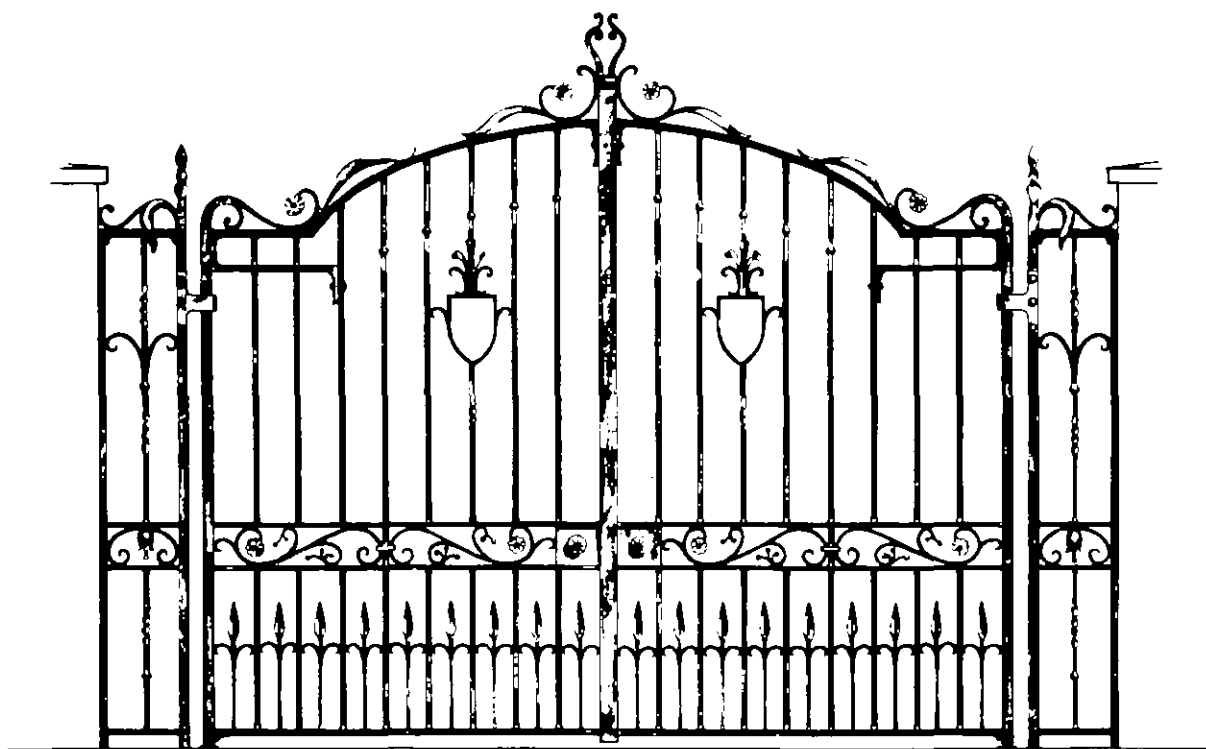

1562

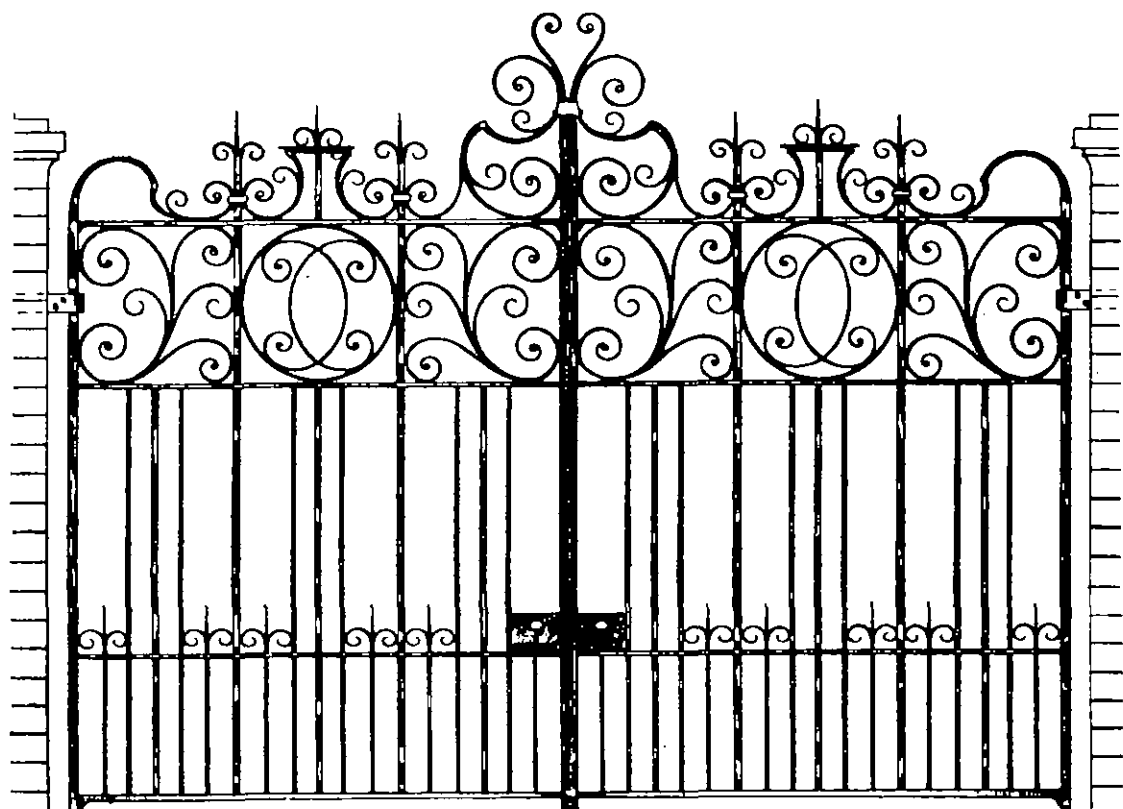

1563

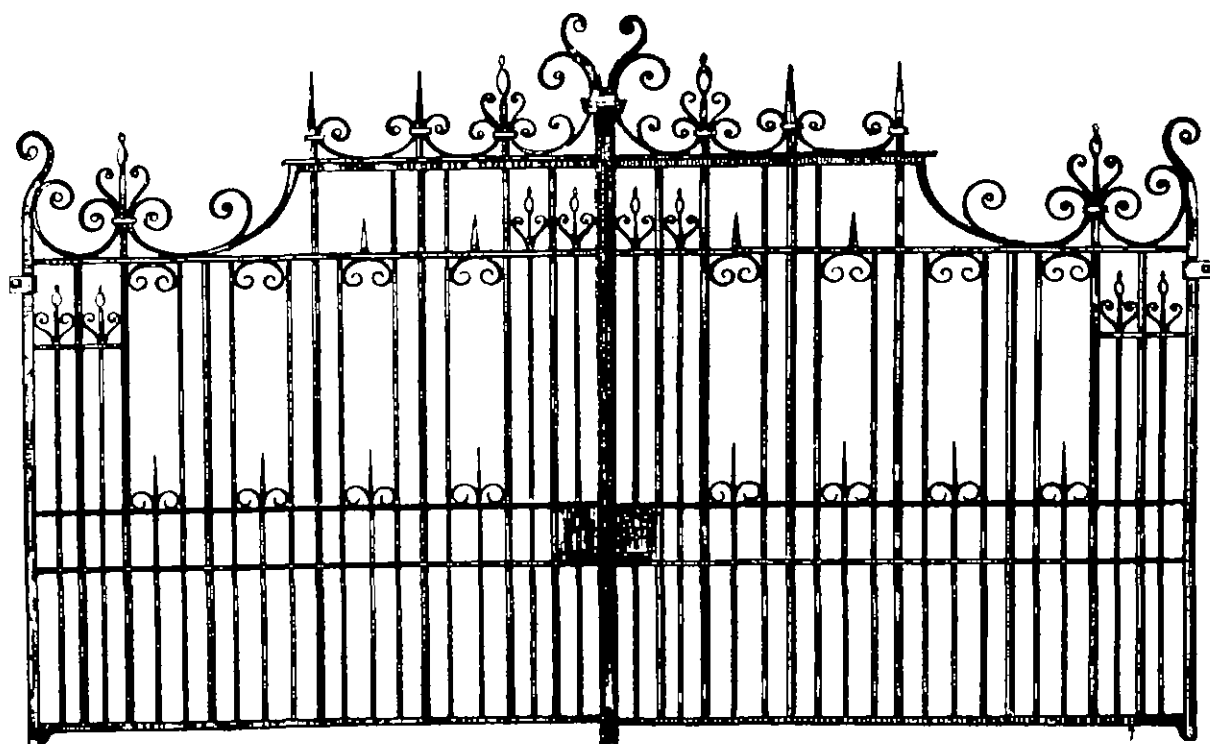

1564

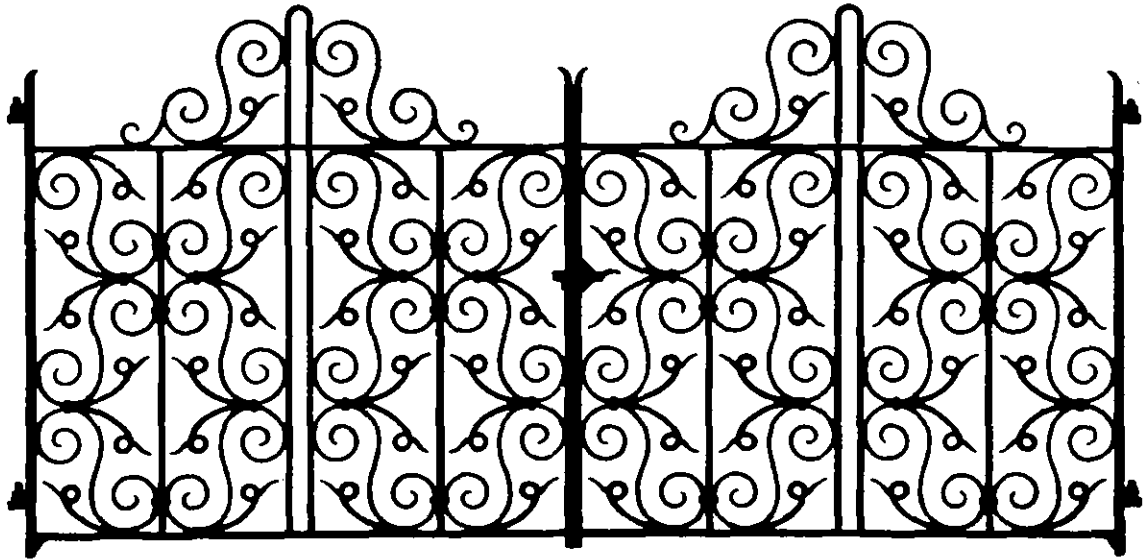

1565

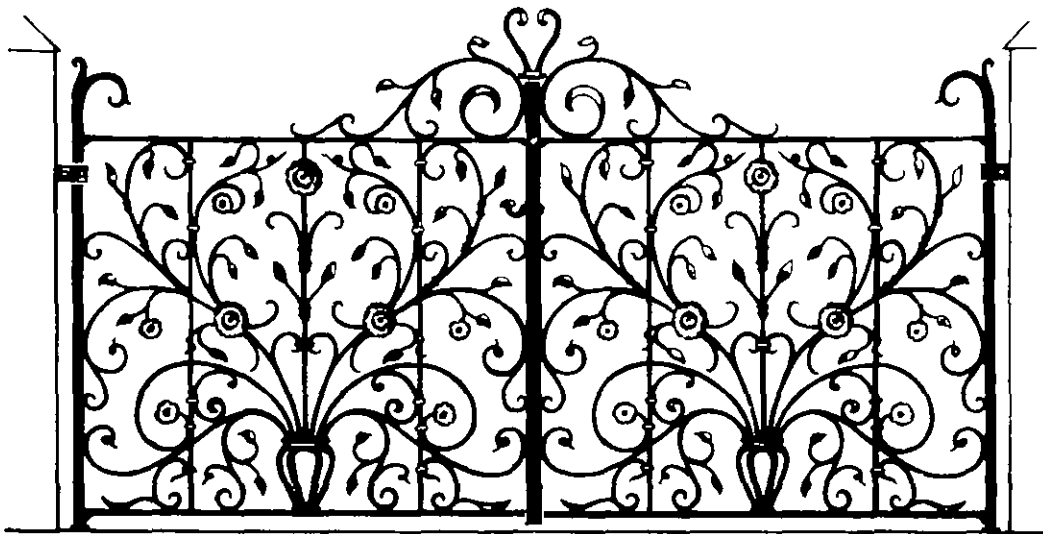

1566

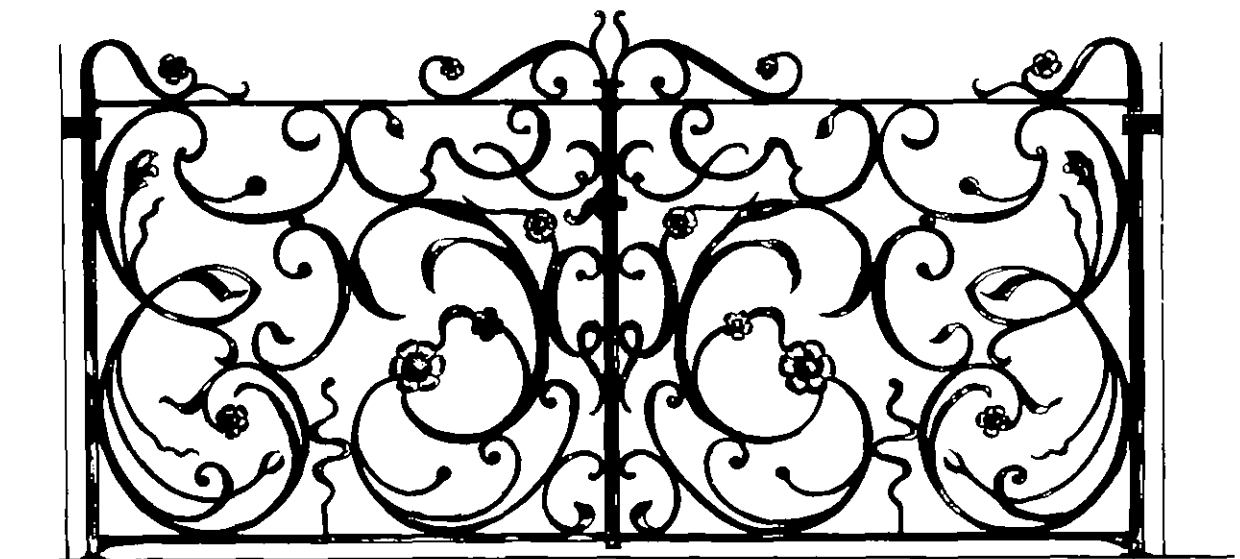

1567

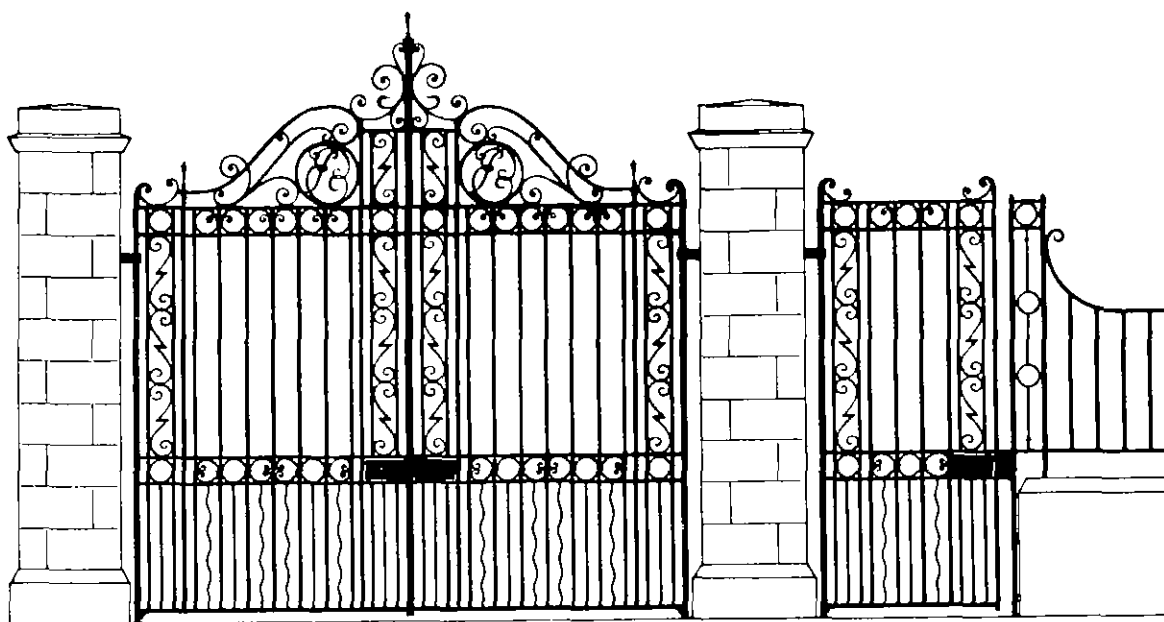

1568

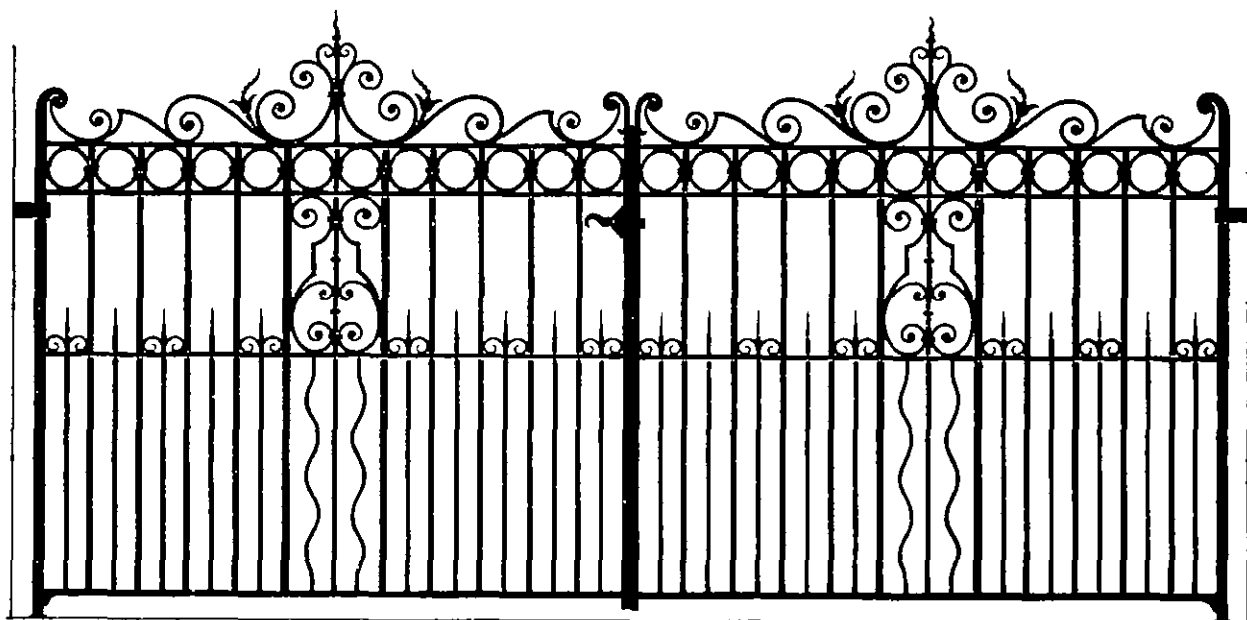

1569

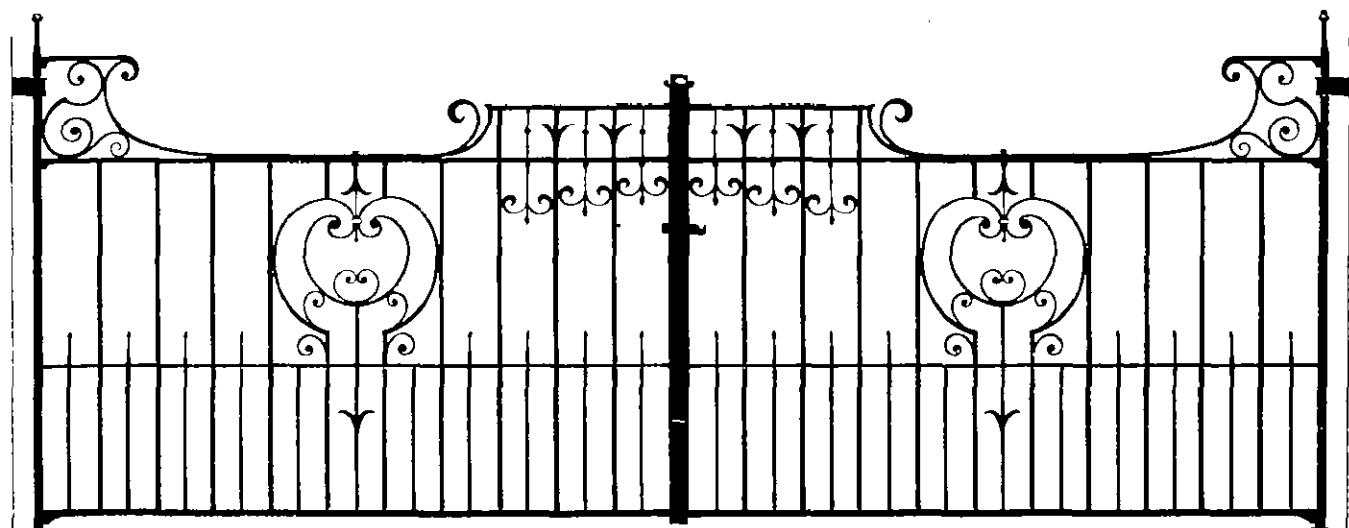

1570

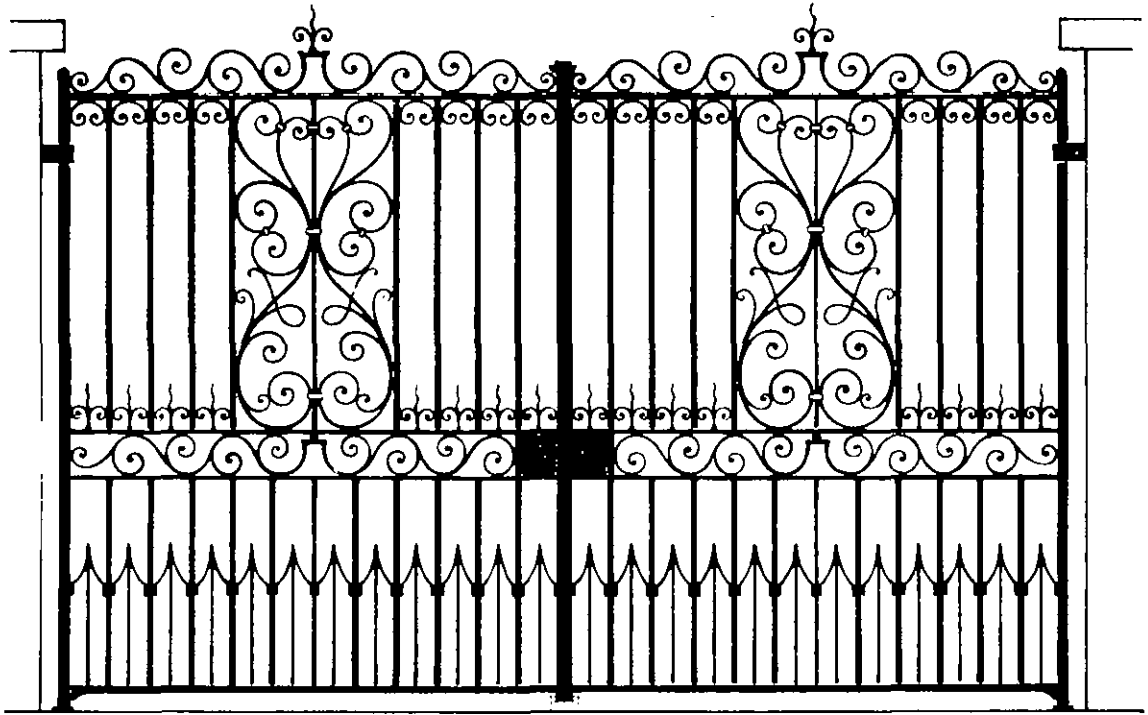

1571

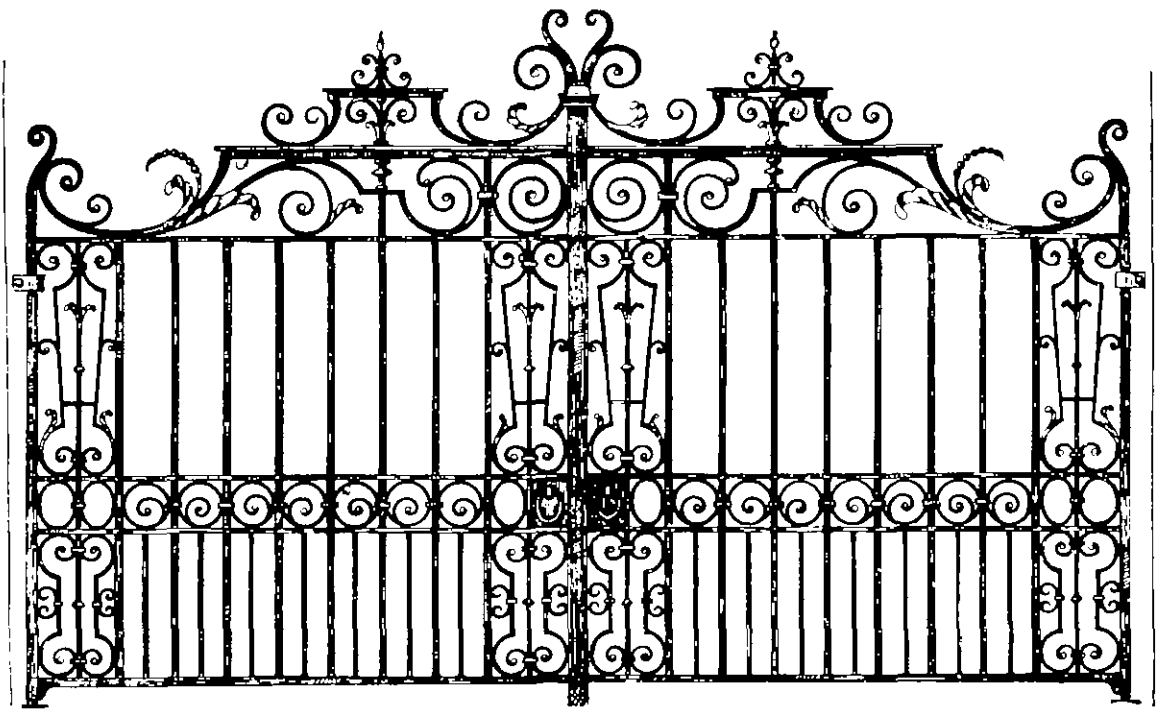

1572

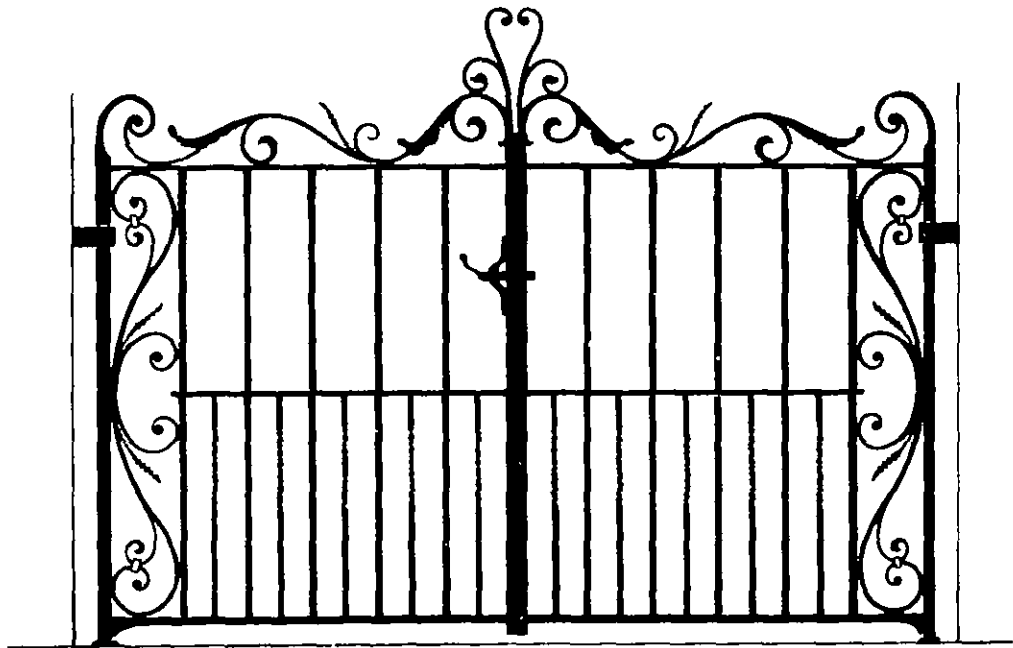

1573

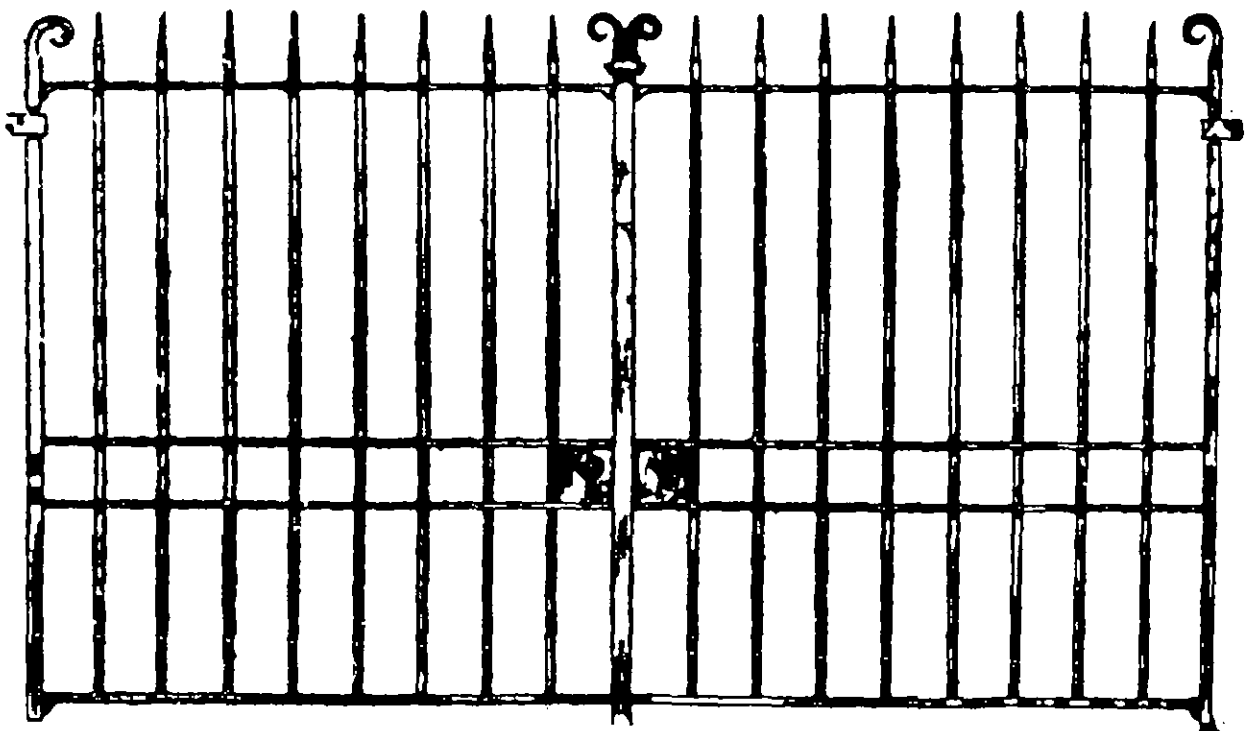

1574

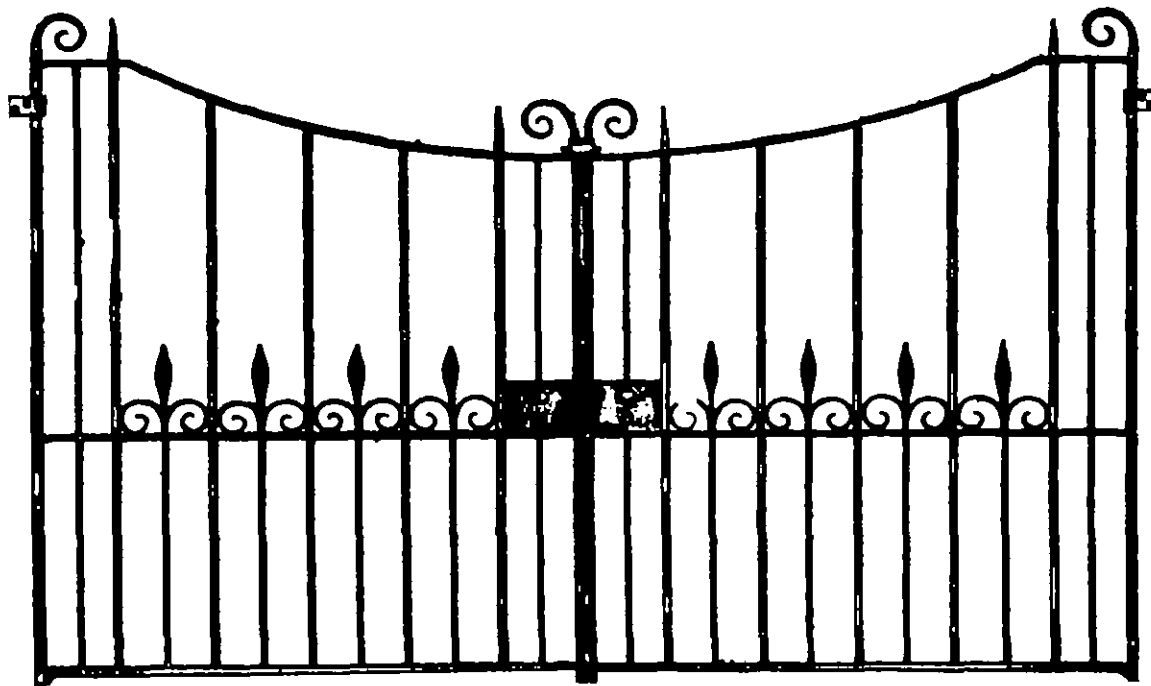

1575

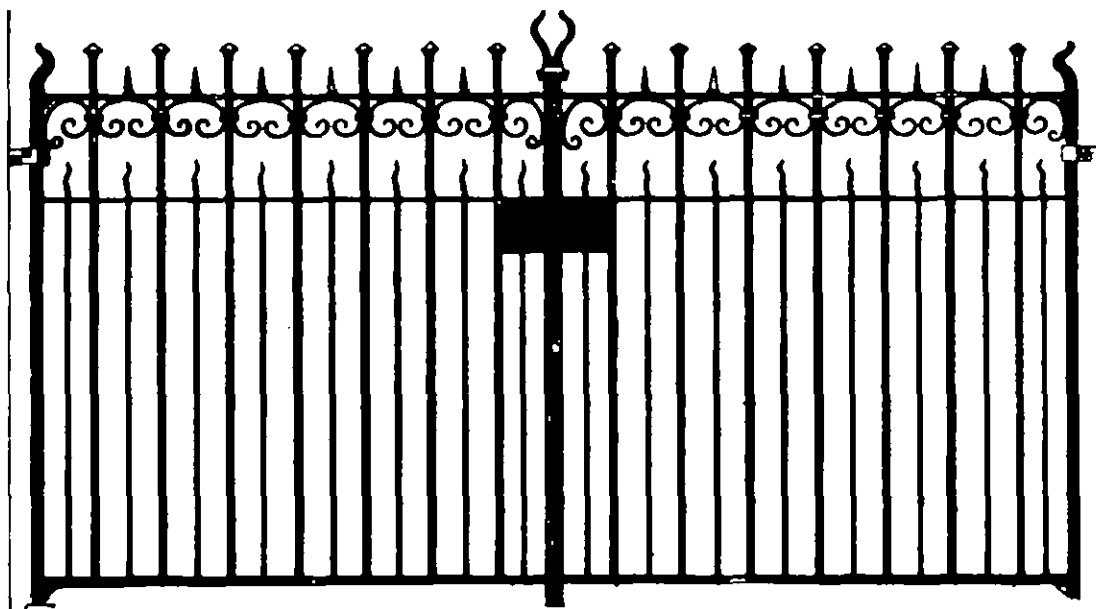

1576

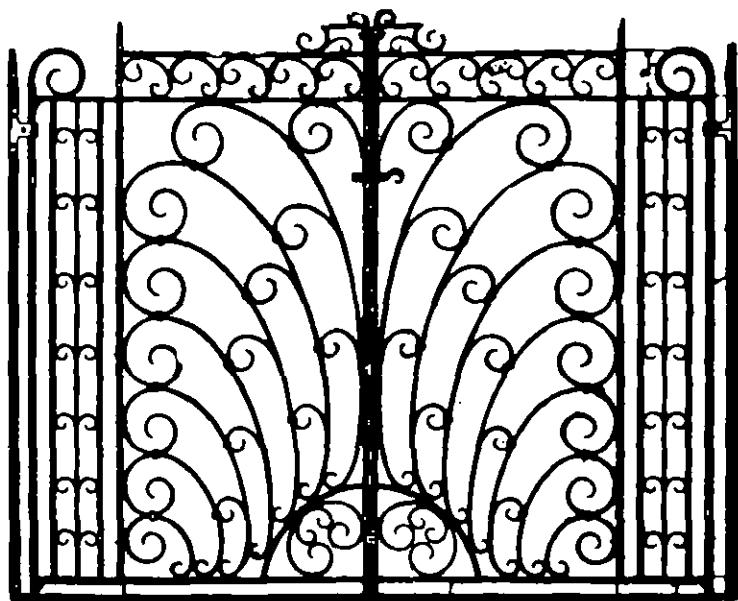

1577

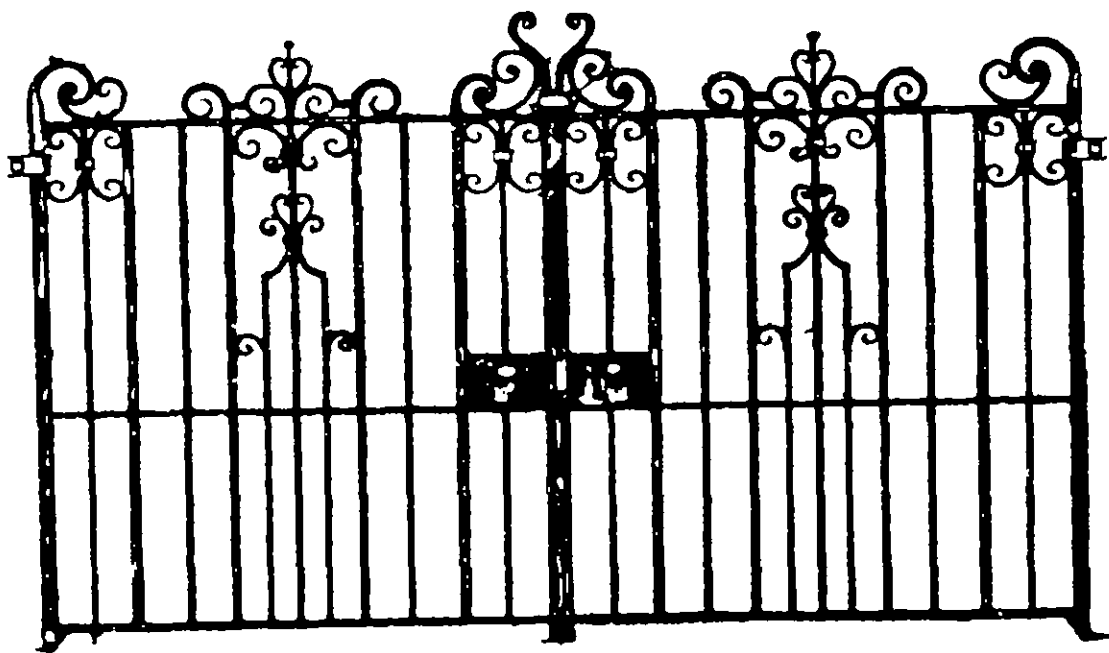

1578

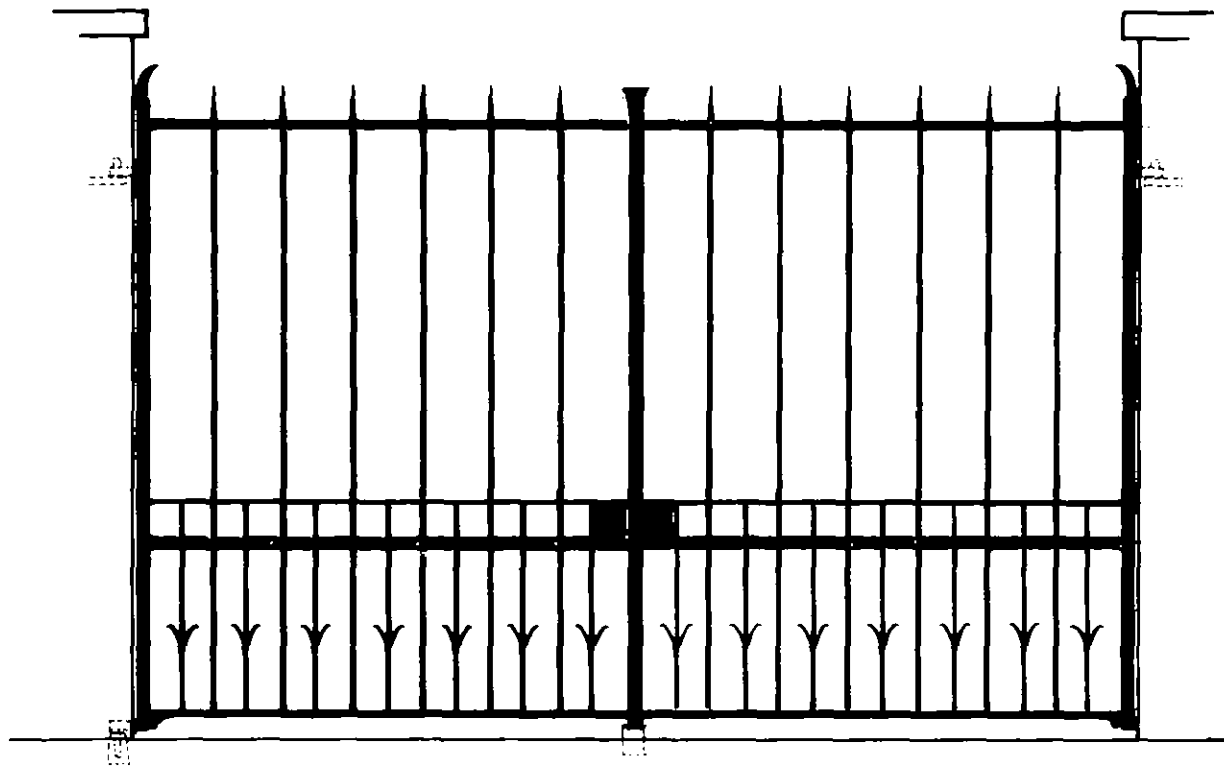

1579

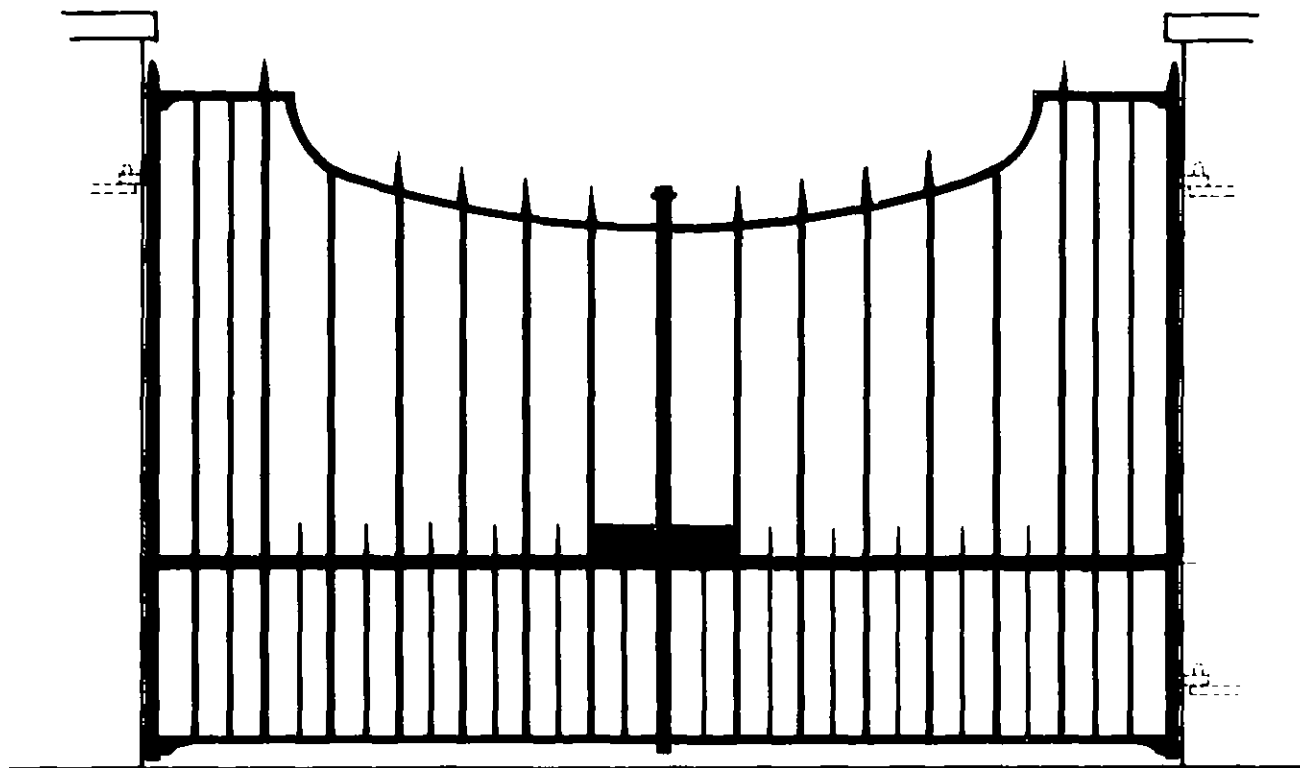

1580

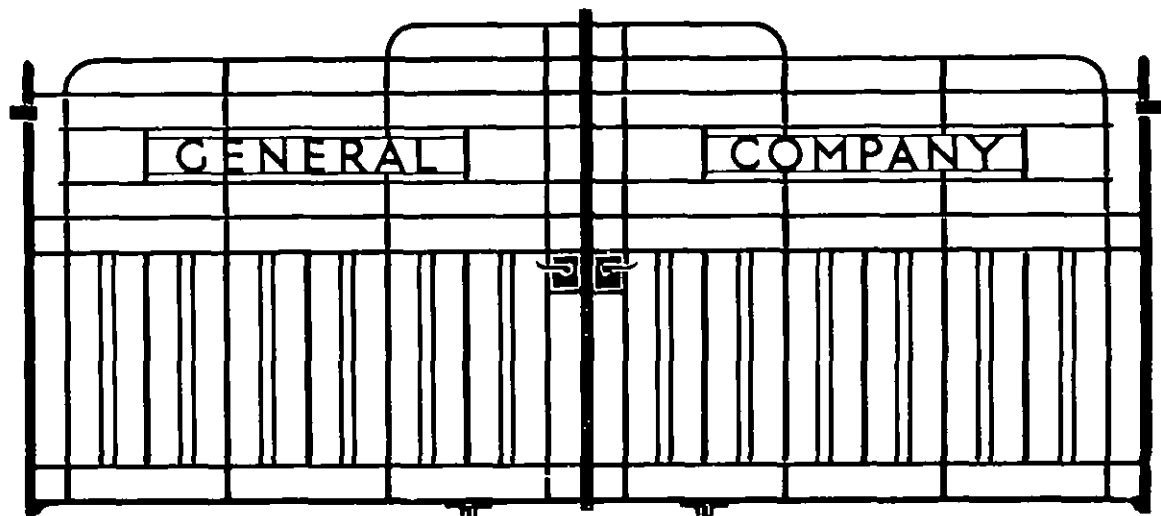

1581

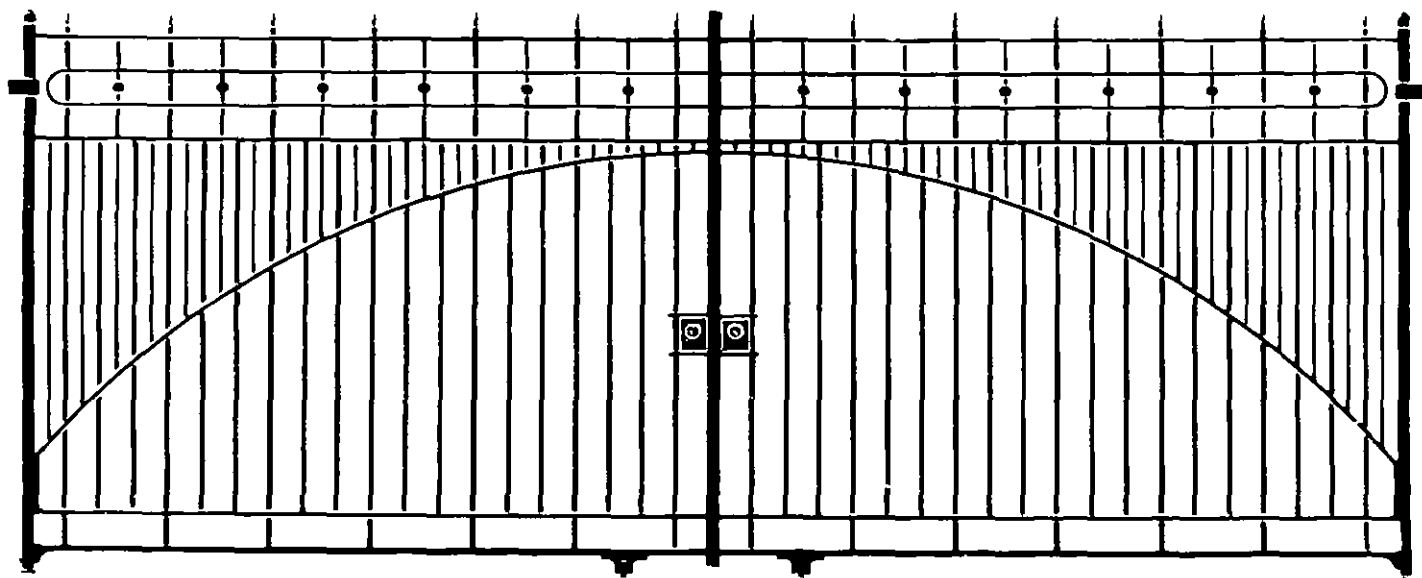

1582

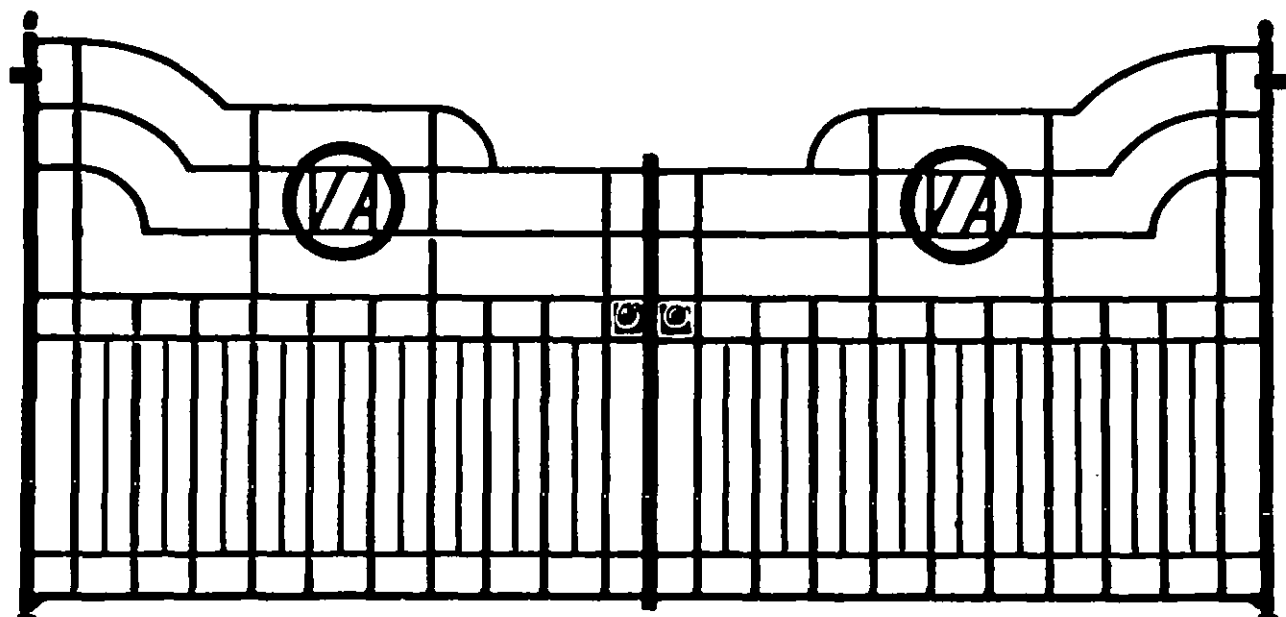

1583

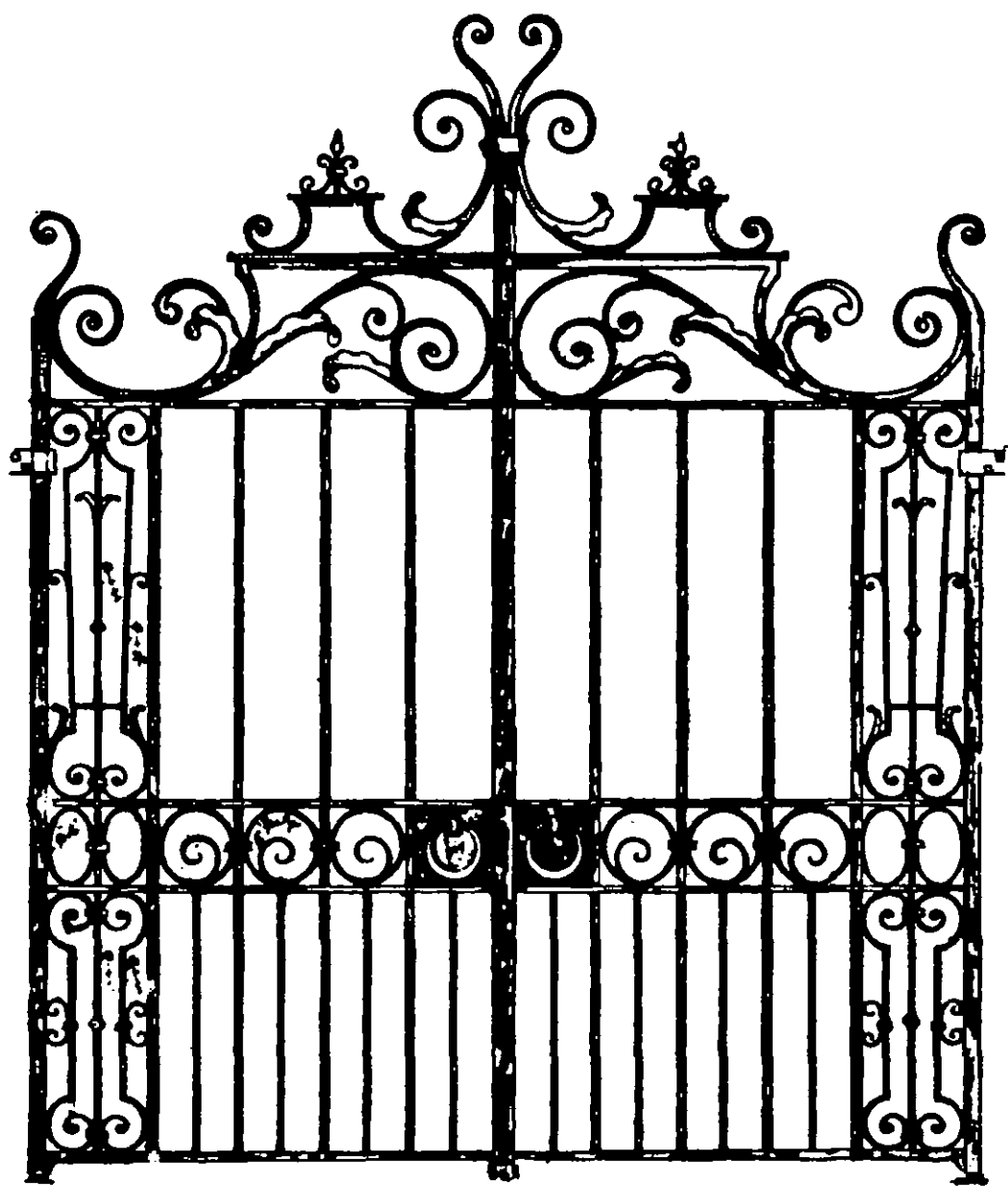

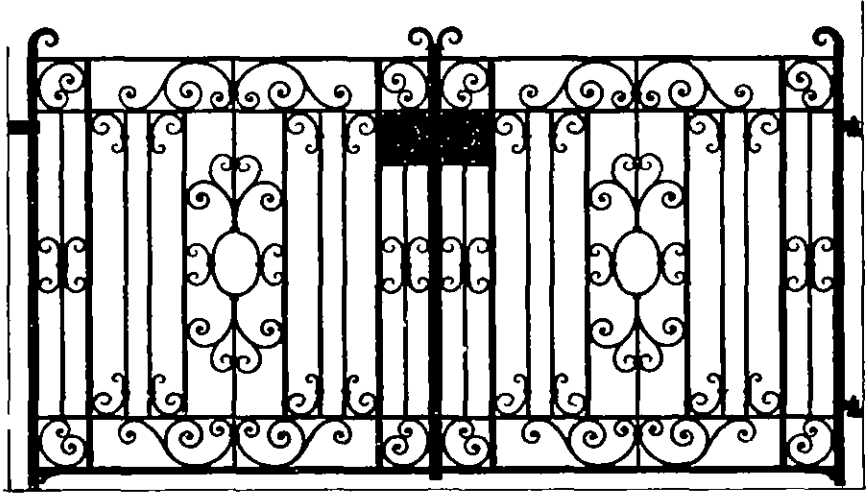

1585

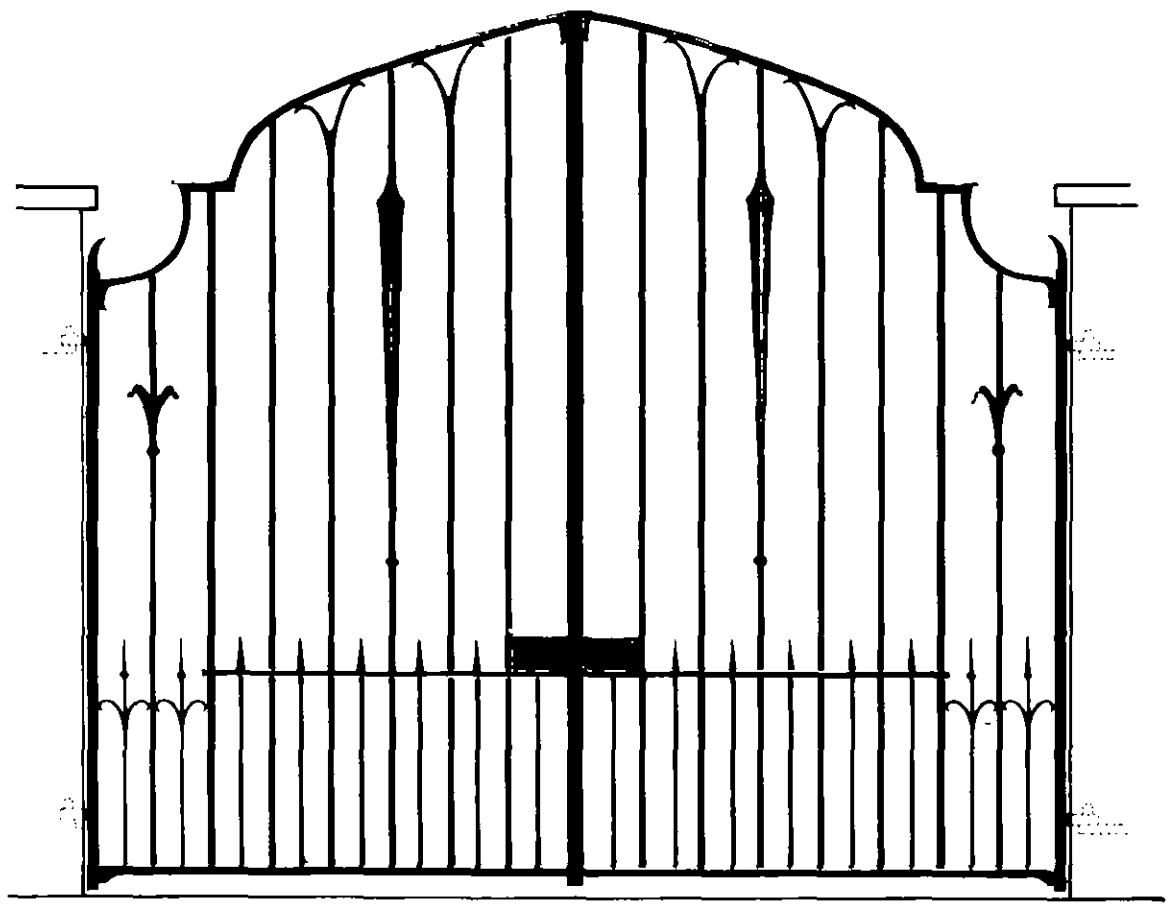

1586

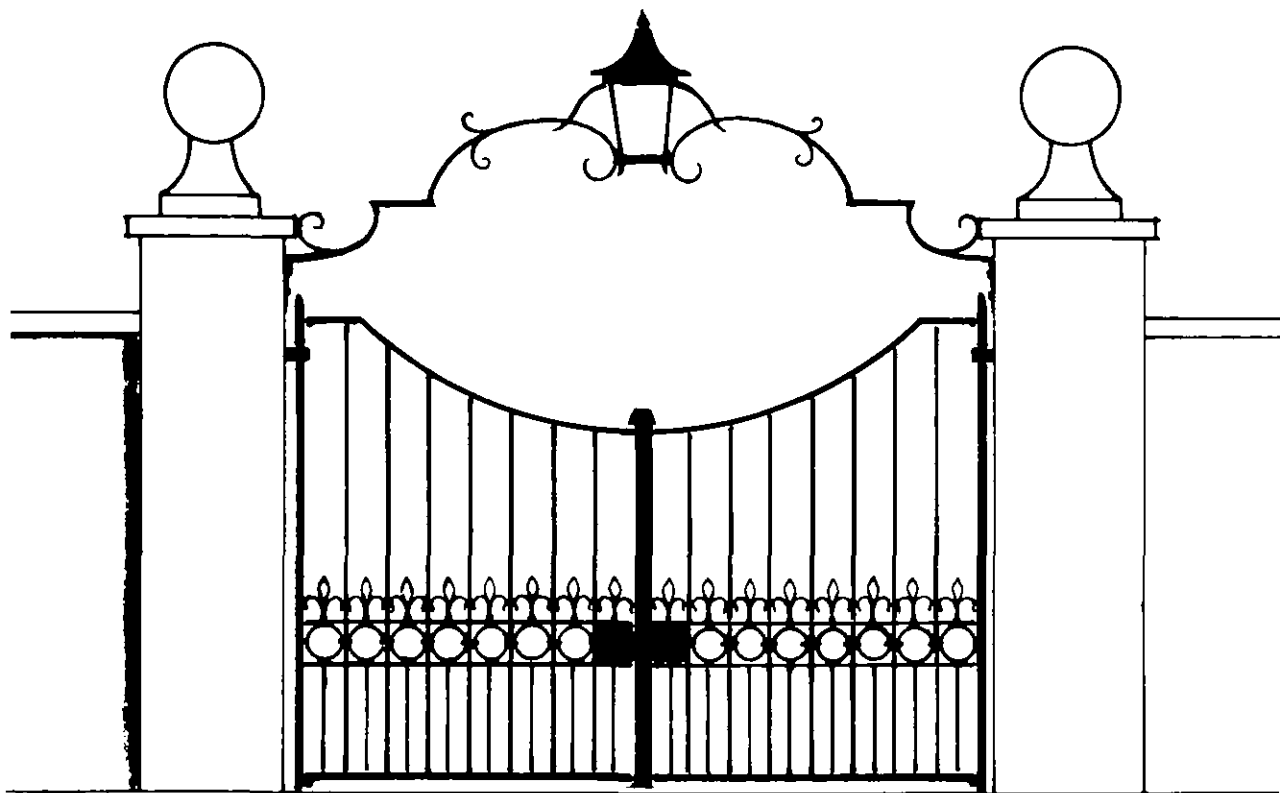

1587

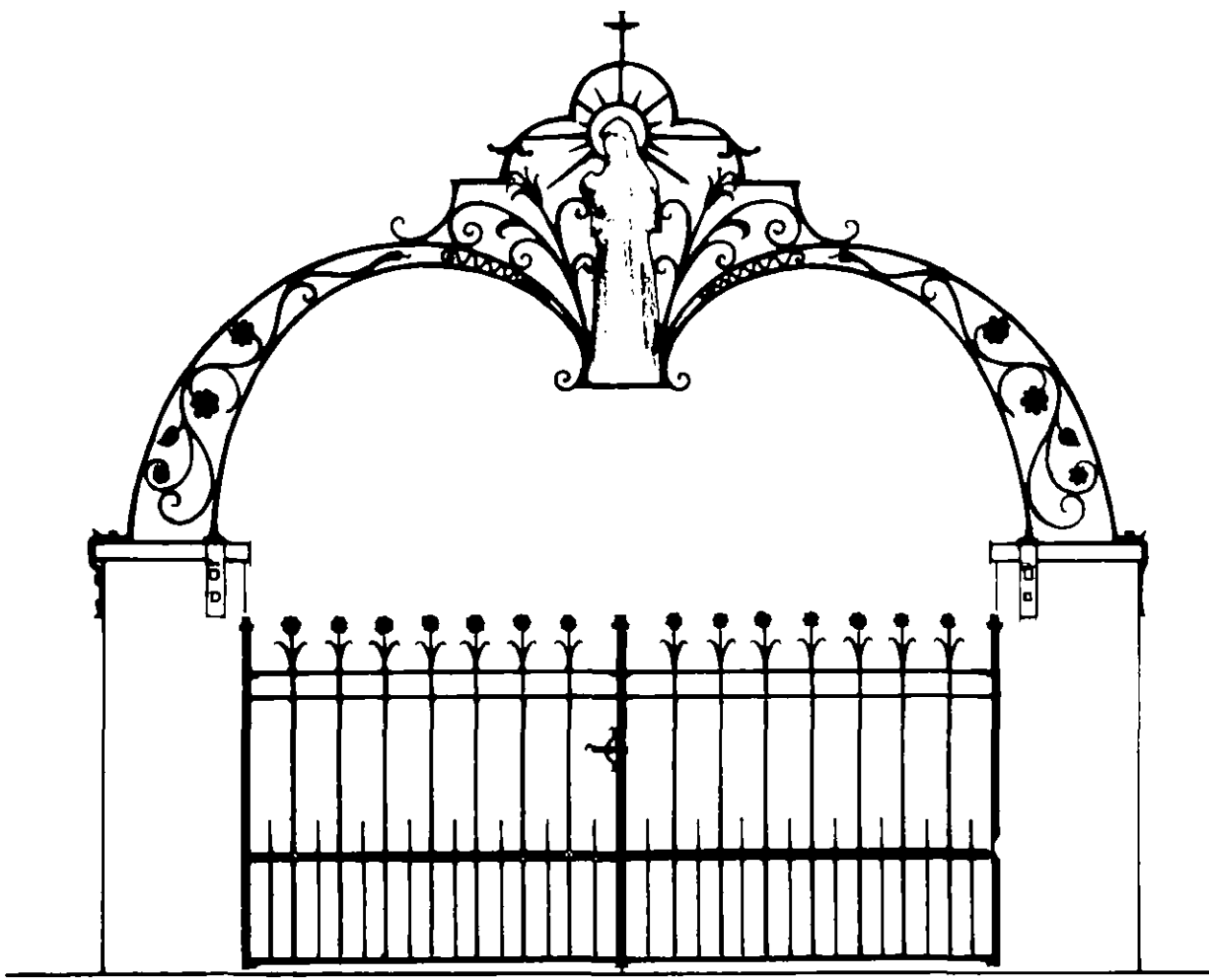

1588



1589



1590

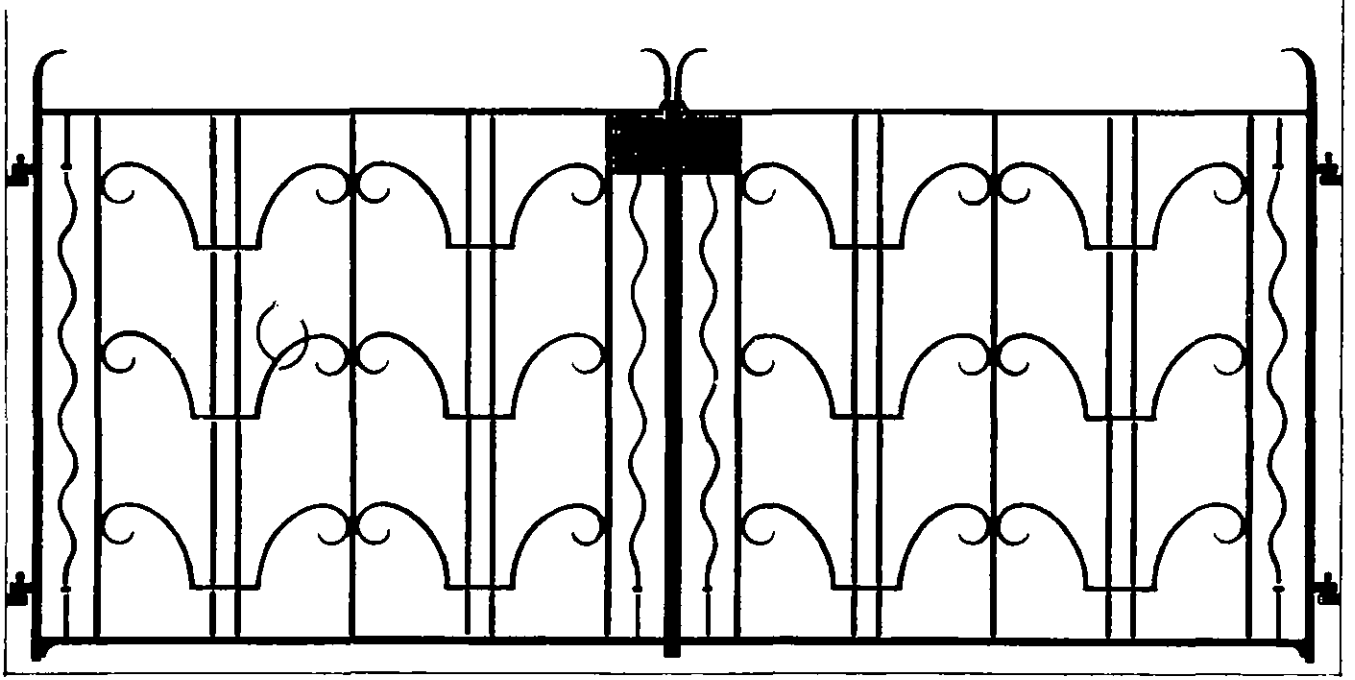

1591

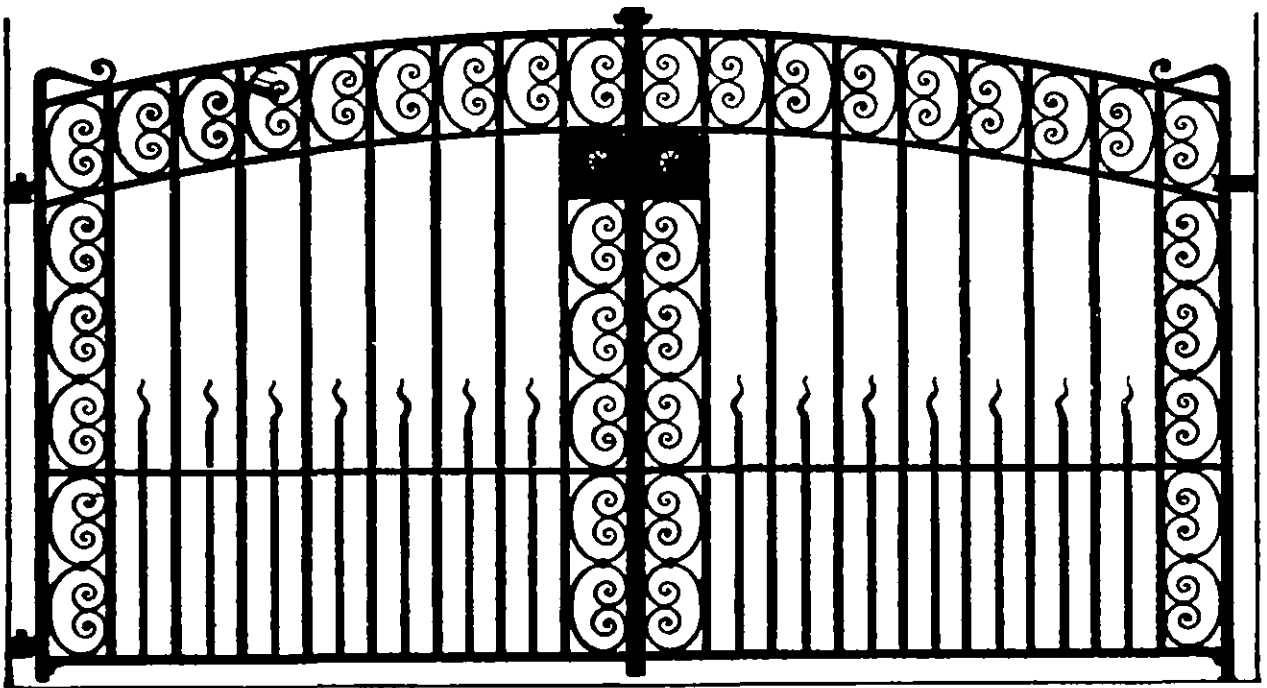

1592

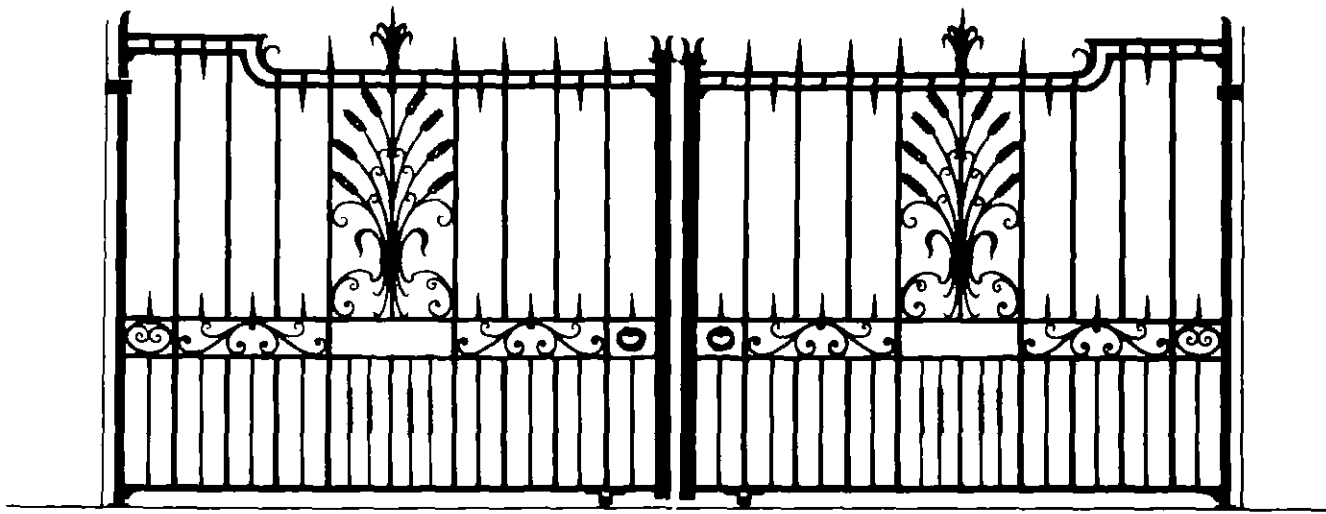

1593

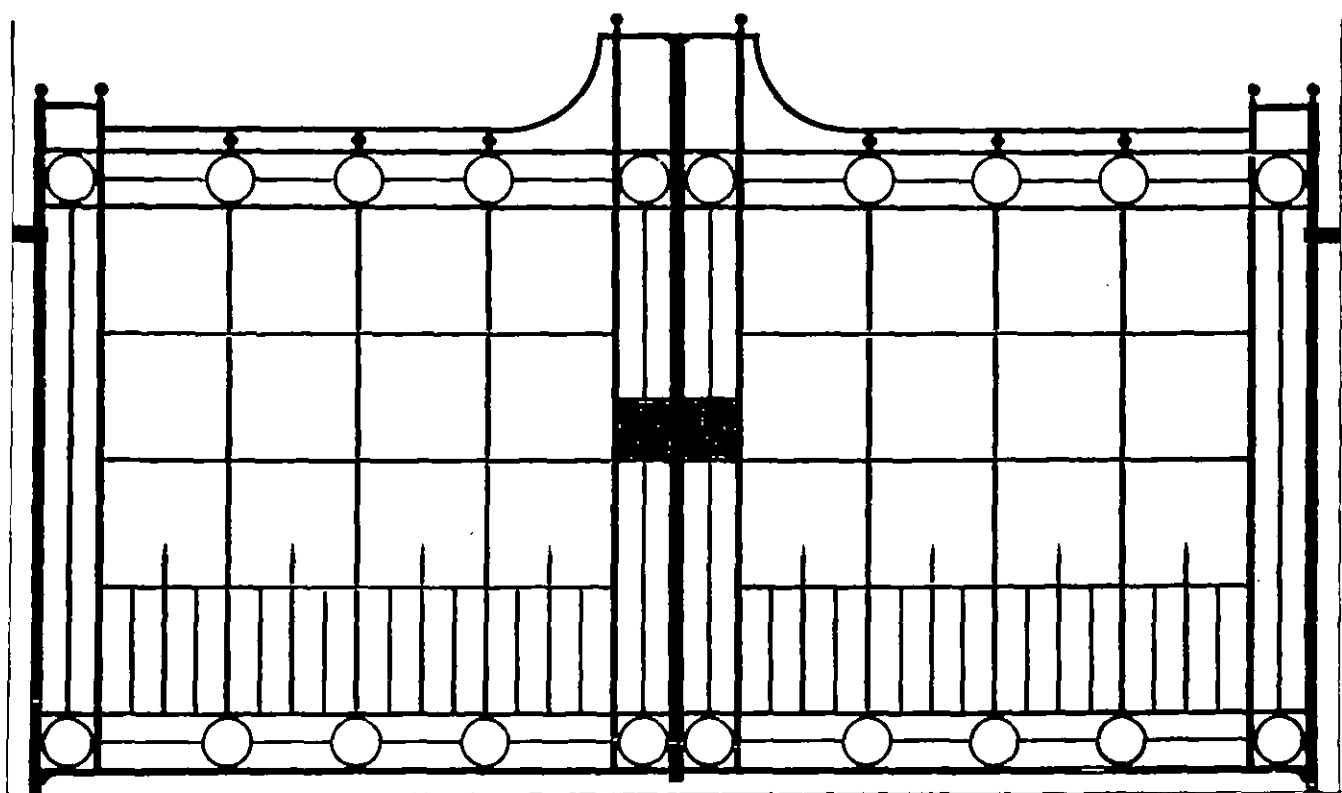

1594

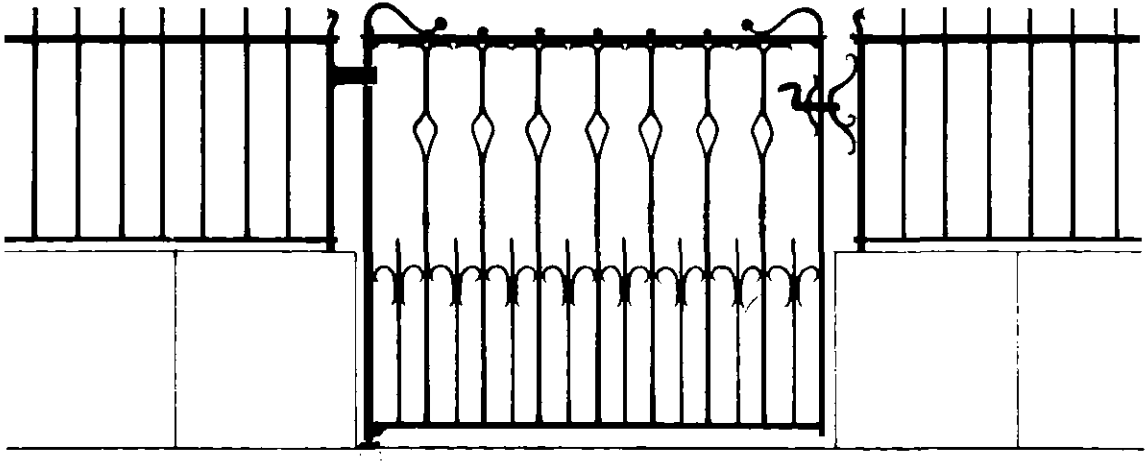

1595



1596

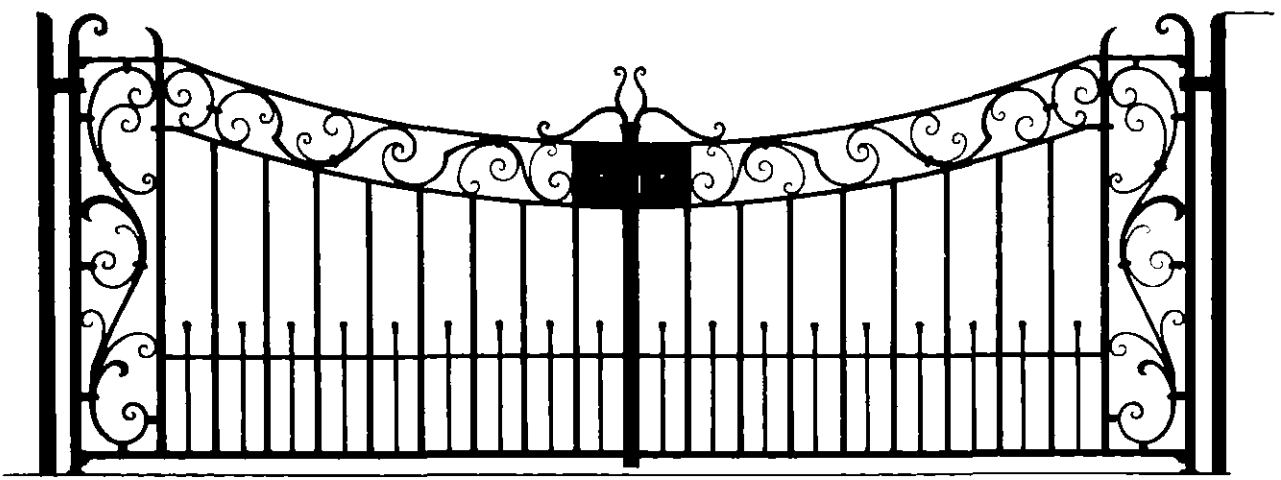

1597

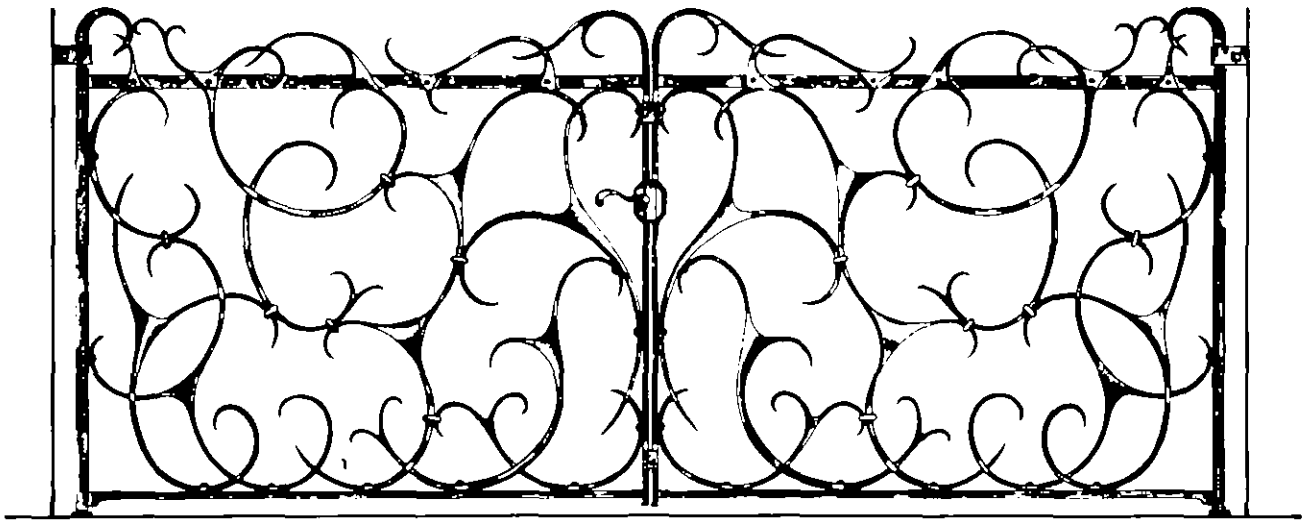

1598

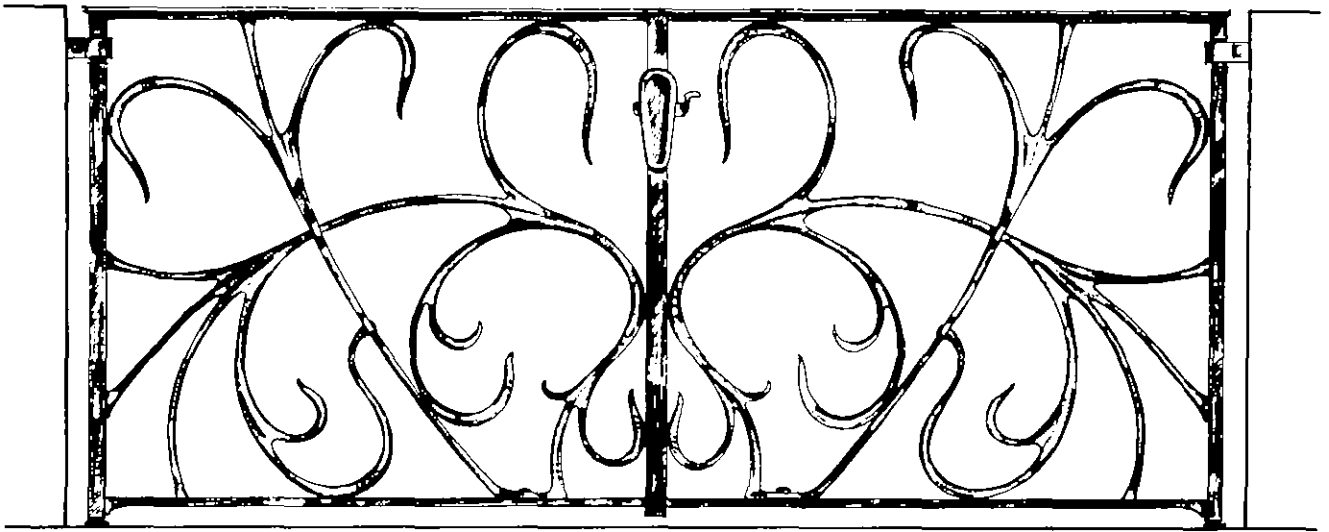

1599



1600

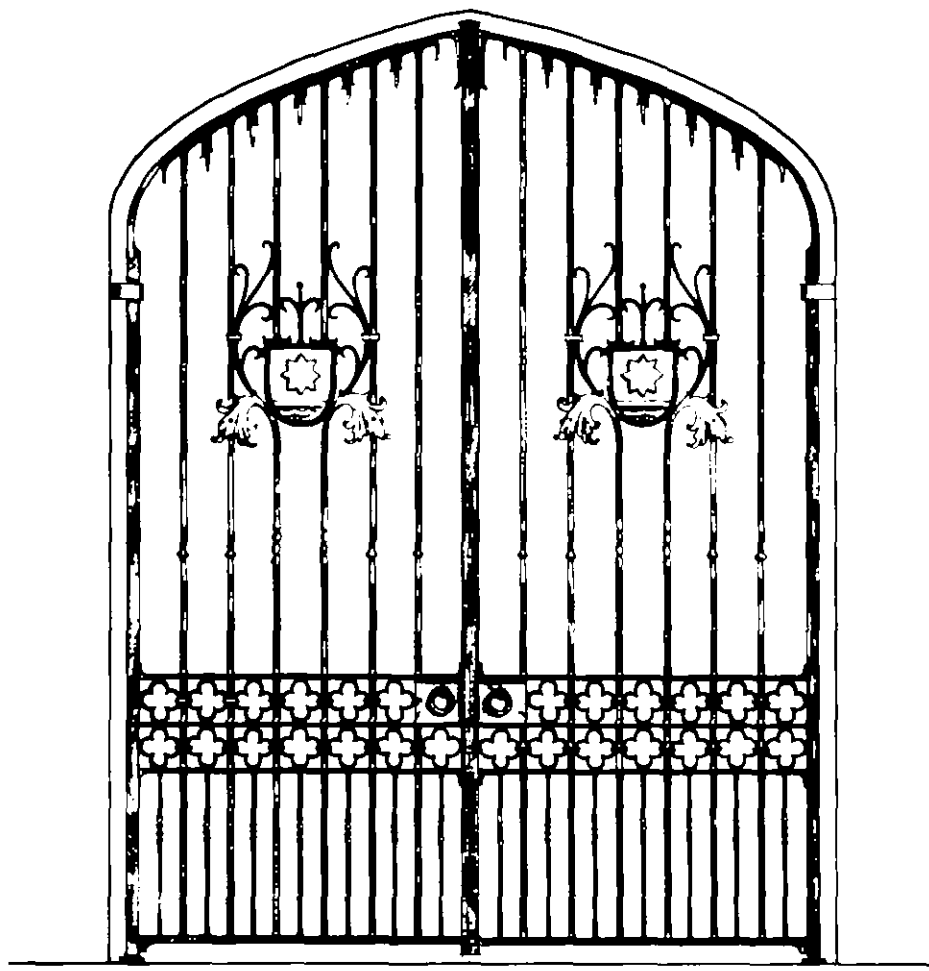

1601

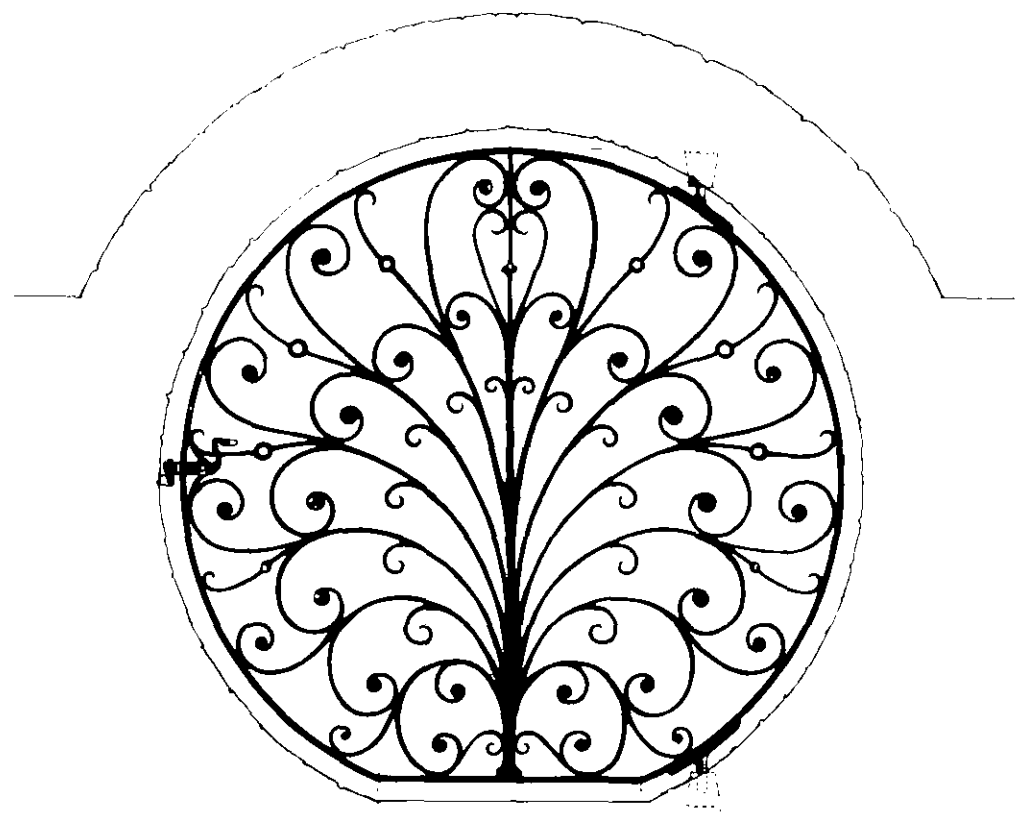

1602

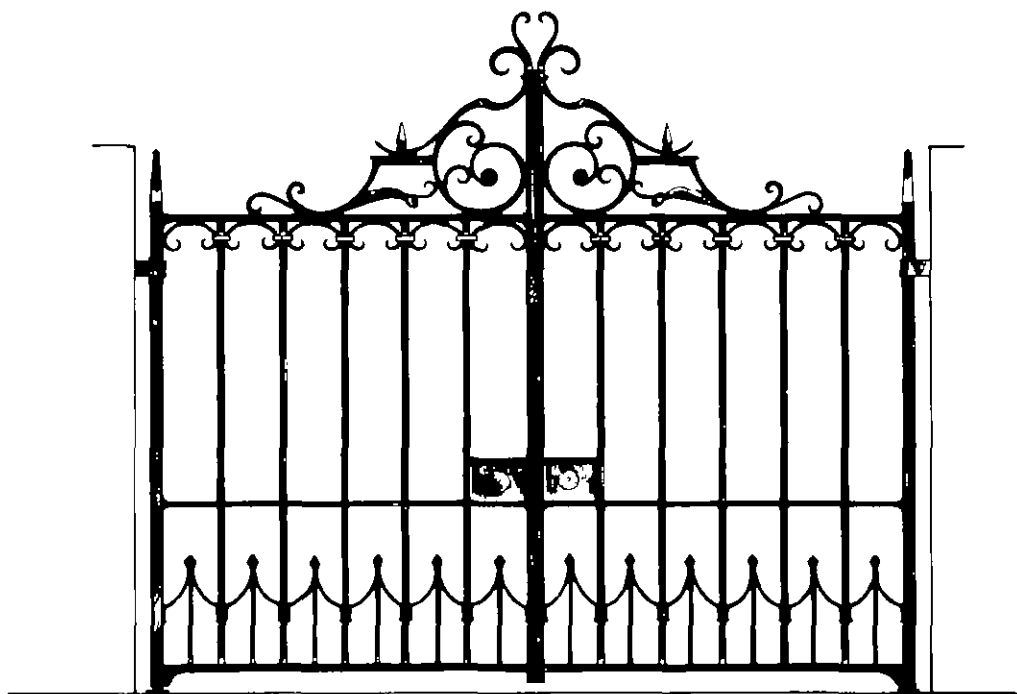

1603

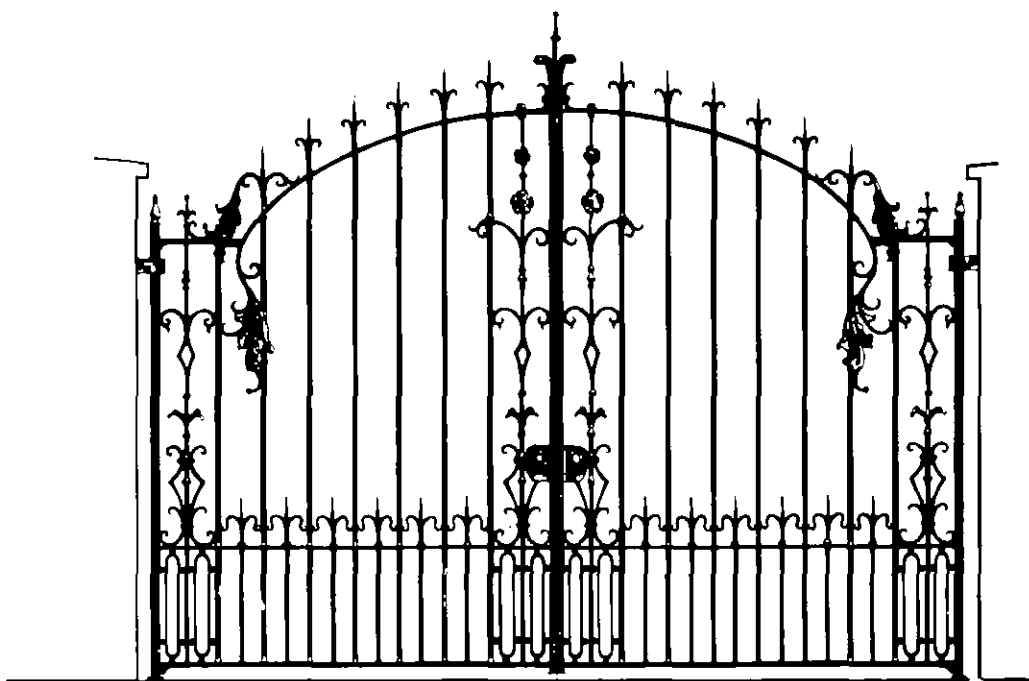

1604

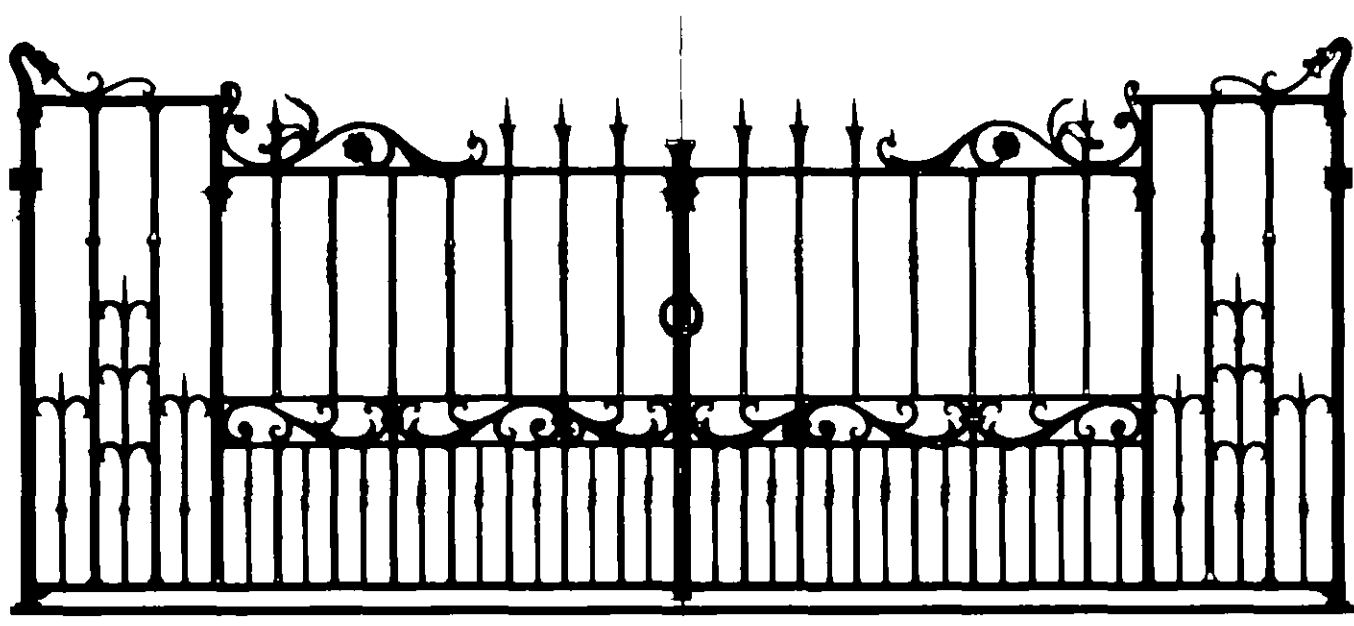

1605

Tools

2200	2'1" × 1'4" sheet
2201	2'4" × 2' sheet
2202	2'6" × 2' sheet
2203	2'5" × 2'7" sheet

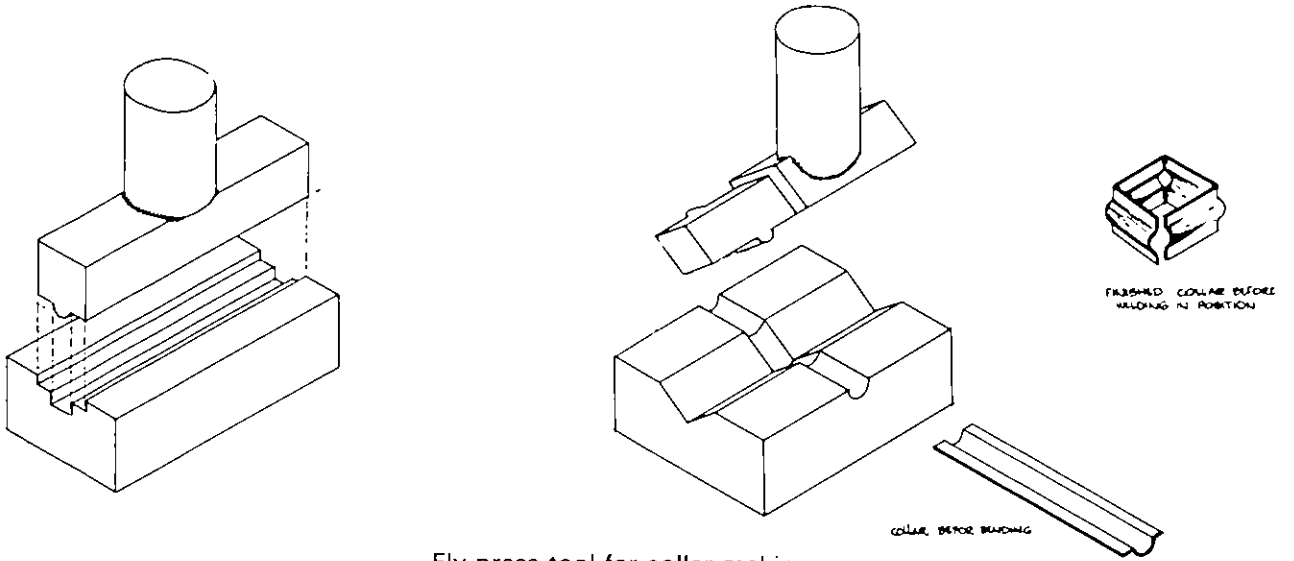

Fly press tool for collar making

2200

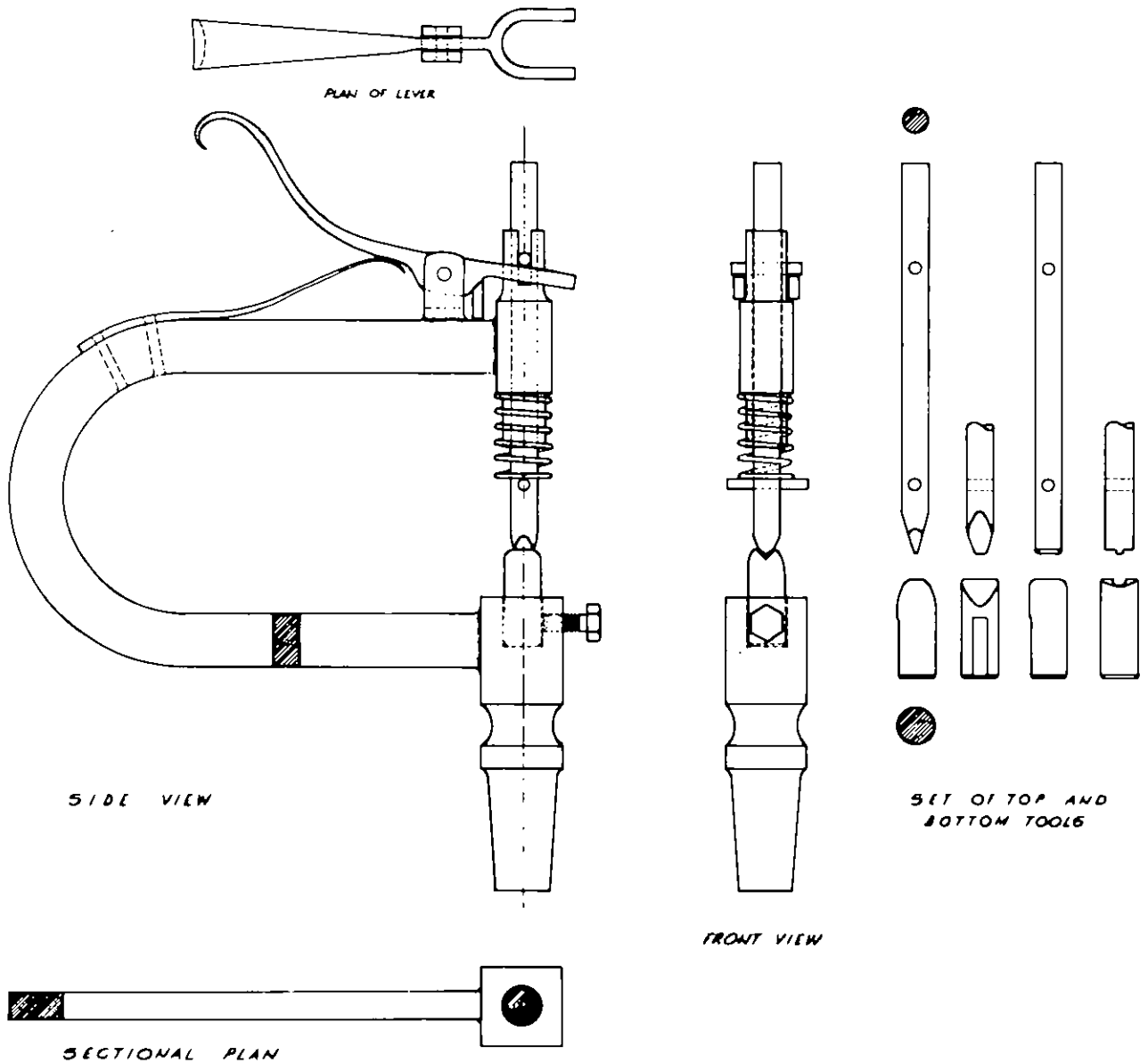

Spring tool for leaf veining

2201

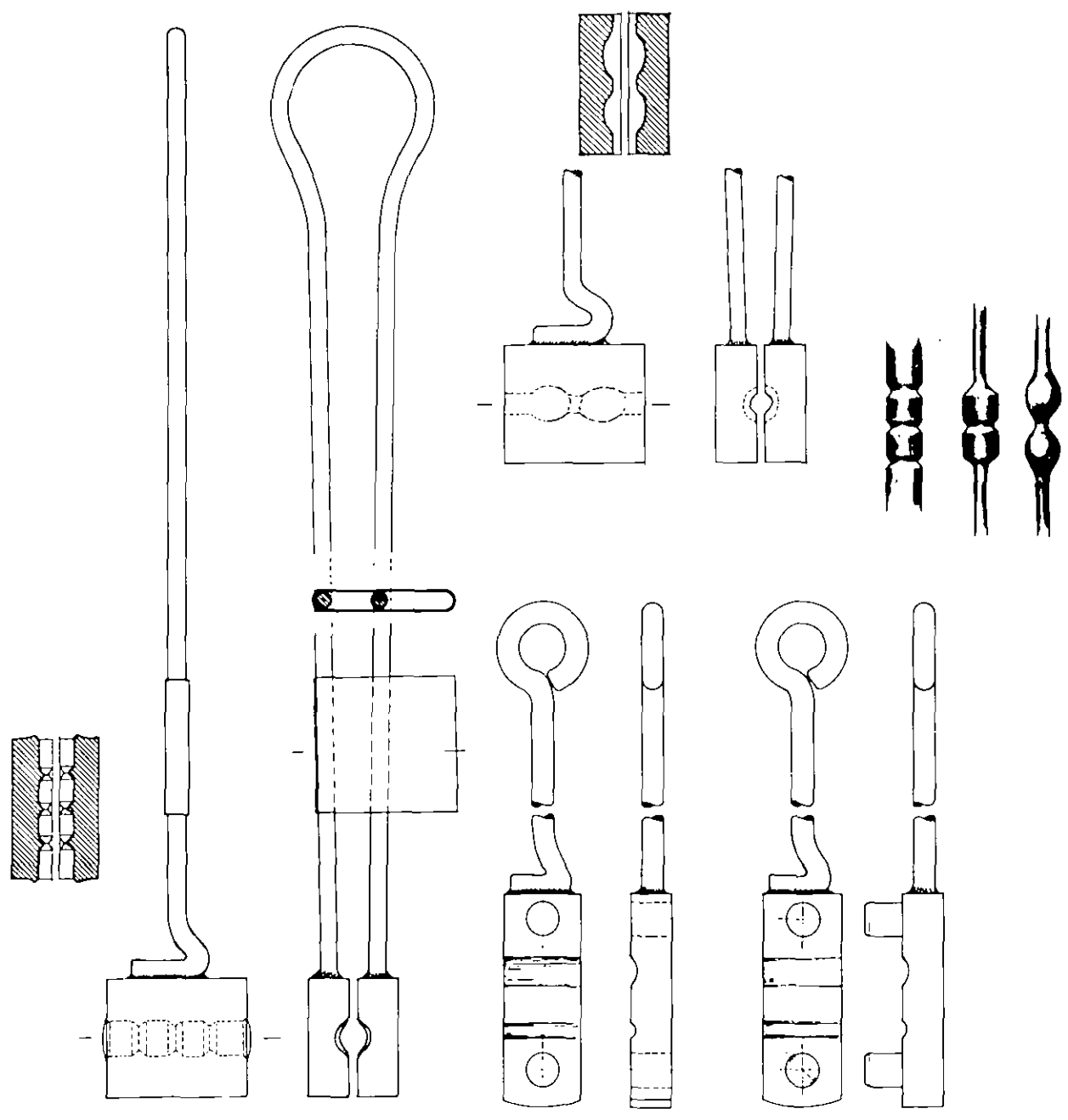

Set of three power hammer tools

2202

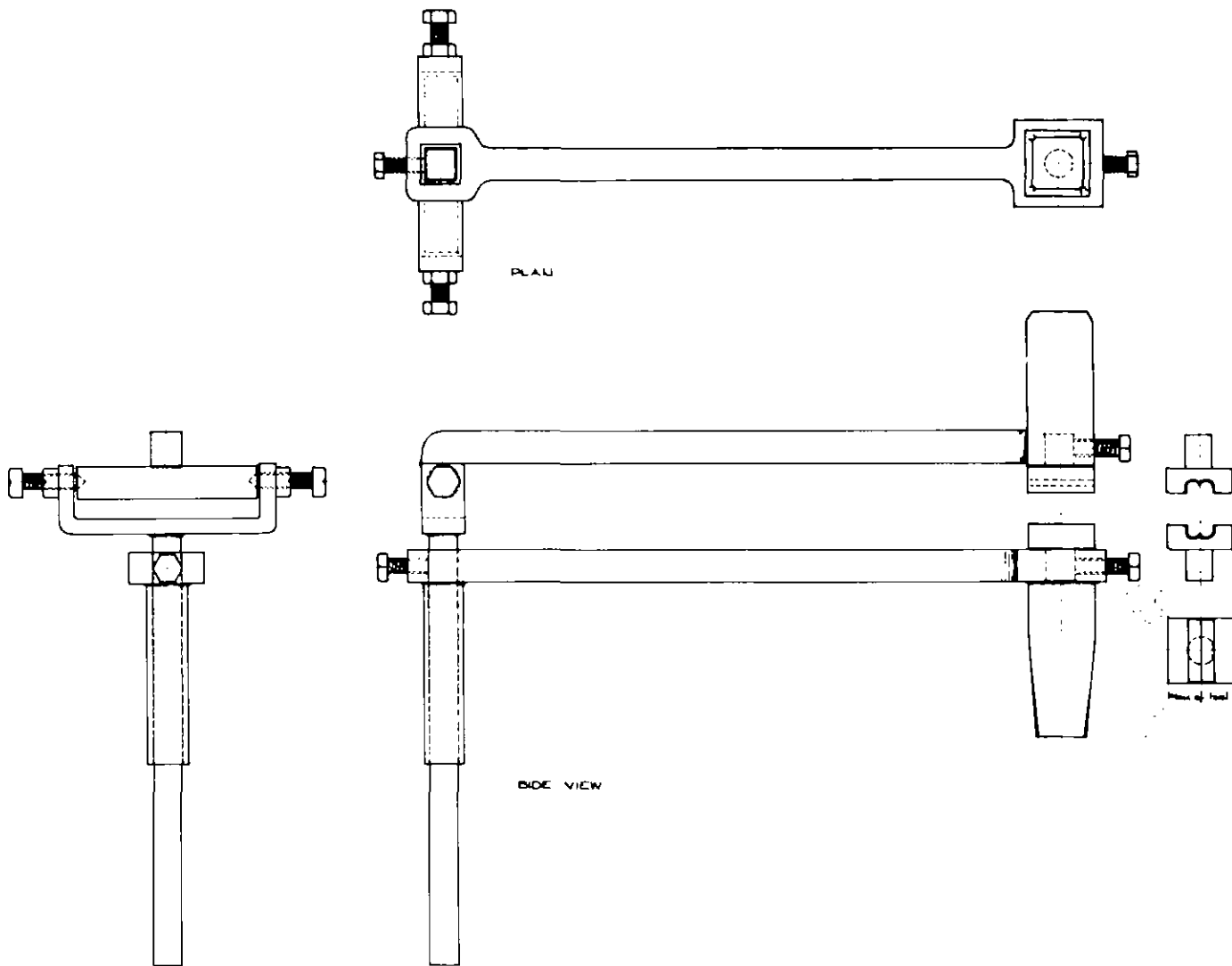

Hinged appliance for top and bottom tools

2203

Leaf development

- 2400 2'8" × 1'4" sheet
- 2401 2'1" × 1'5" sheet
- 2402 1'6" × 11" sheet
- 2403 1'9" × 1'8" sheet
- 2404 2'4" × 1'9" sheet

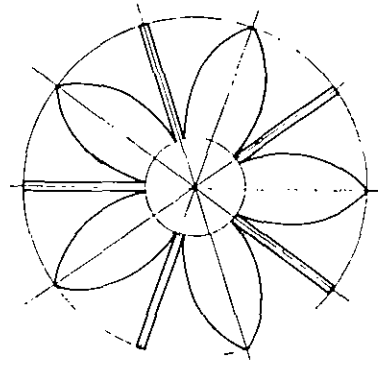
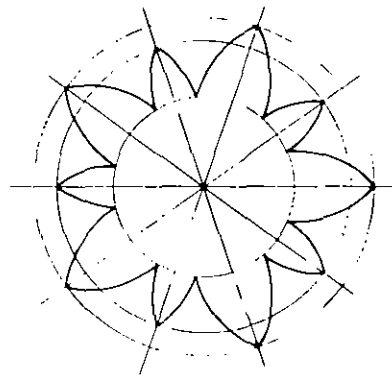
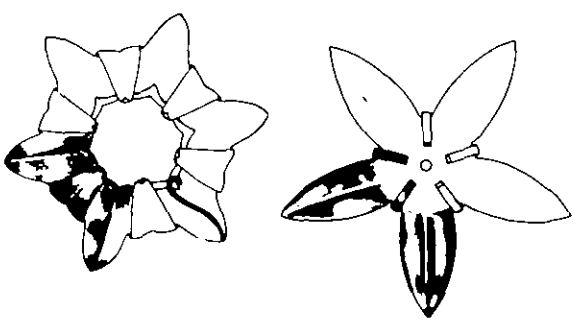

2400

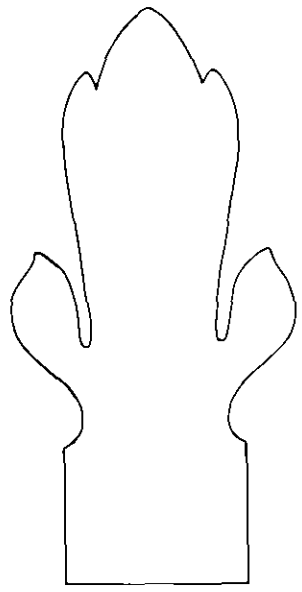
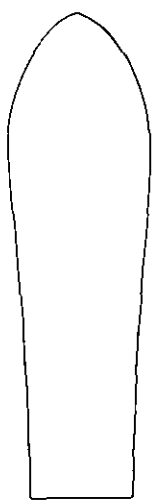
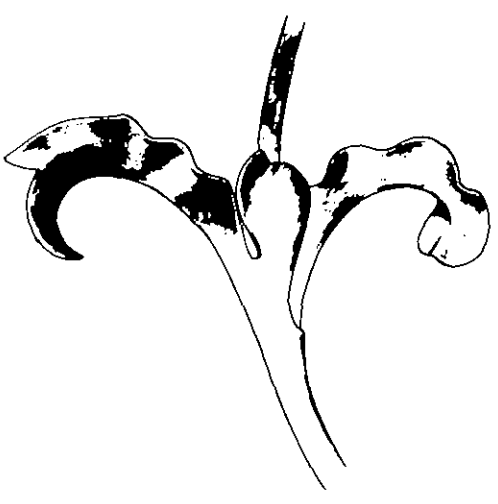

LEAF DEVELOPMENT

2401

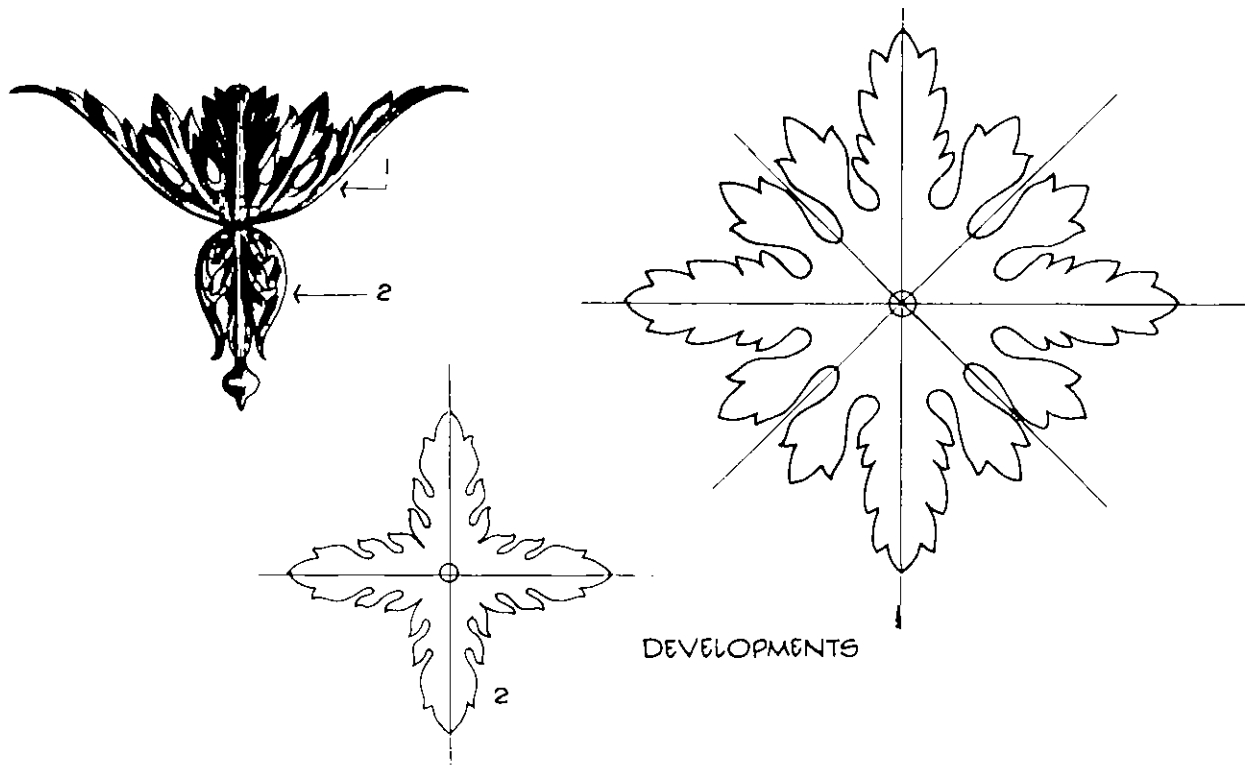

2402

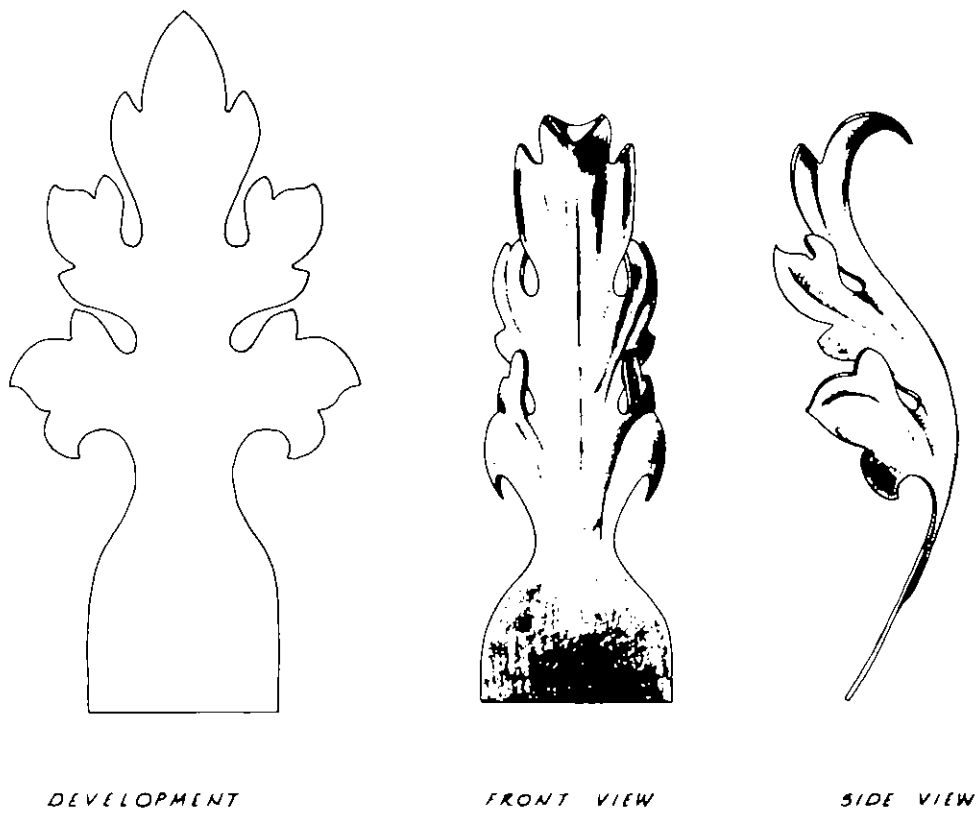

2403



2404

